

Nationale Hinterlegungen

In der folgenden Liste werden die beim Eidgenössischen Institut für Geistiges Eigentum hinterlegten Designs publiziert. Dabei sind der Reihe nach angegeben:

- internationale Klassenangaben
- Hinterlegungsnummer
- Hinterlegungsdatum
- Allenfalls Aufschub der Veröffentlichung
- Anzahl der hinterlegten Designs
- Bezeichnung
- Name und Wohnsitz des Hinterlegers oder der Hinterlegerin
- gegebenenfalls Name und Wohnsitz des Designers oder der Designerin
- Name und Geschäftssitz des allfälligen Vertreters oder der Vertreterin
- gegebenenfalls Prioritätsangaben
- gegebenenfalls Beschreibungstext
- Ordnungsnummer
- Reproduktion des Designs

Internationale Hinterlegungen

Die bei der Weltorganisation für geistiges Eigentum in Genf hinterlegten Muster und Modelle mit Benennung Schweiz geniessen den gleichen Schutz wie national hinterlegte Designs. Sie werden jeweils im Blatt «Bulletin des dessins et modèles internationaux» veröffentlicht. Dieses Publikationsorgan ist deshalb für eine vollständige Recherche unbedingt beizuziehen.

Topographien

Angaben über die vom Eidgenössischen Institut für Geistiges Eigentum eingetragenen Topographien von Halbleitererzeugnissen werden in folgender Anordnung aufgeführt:

- Eintragsnummer
- Anmeldedatum
- Bezeichnung
- Name und Wohnsitz des Anmelders oder der Anmelderin
- gegebenenfalls Name und Wohnsitz des Herstellers oder der Herstellerin
- Name und Geschäftssitz des oder der allfälligen Bevollmächtigten
- Datum und Ort einer allfälligen ersten geschäftlichen Verbreitung der Topographie

Dépôts nationaux

Les designs déposés à l'Institut Fédéral de la Propriété Intellectuelle sont publiés dans la liste qui suit. Les indications y relatives sont mentionnées dans cet ordre:

- indications des classes internationales
- numéro de dépôt
- date de dépôt
- le cas échéant, ajournement de la publication
- nombre des designs déposés
- désignation
- nom et domicile du/de la déposant/e
- le cas échéant, nom et domicile du/de la designer
- nom et domicile de l'éventuel/le mandataire
- le cas échéant, indication de priorité
- le cas échéant, description du design
- numéro attribué à chaque design
- reproduction du design

Dépôts internationaux

Les dessins et modèles déposés à l'Organisation Mondiale de la Propriété Intellectuelle à Genève qui désignent la Suisse jouissent de la même protection que les dépôts nationaux. Ils sont chaque fois publiés dans la feuille «Bulletin des dessins et modèles internationaux». Pour une recherche complète, il est indispensable de consulter ledit organe de publication.

Topographies

Les indications concernant les topographies des produits semi-conducteurs, enregistrées par l'Institut Fédéral de la Propriété Intellectuelle, sont énumérées dans l'ordre suivant:

- numéro d'enregistrement
- date de dépôt
- désignation
- nom et domicile du/de la déposant/e
- le cas échéant, nom et domicile du/de la producteur/trice
- nom et domicile de l'éventuel/le mandataire
- date et lieu d'une éventuelle première mise en circulation de la topographie

Depositi nazionali

Nella lista seguente vengono pubblicati i design depositati presso l'Istituto Federale della Proprietà Intellettuale. Sono menzionati nel seguente ordine:

- indicazioni delle classi internazionali
- numero di deposito
- data del deposito
- se del caso, indicazione che la pubblicazione è stata differita
- numero dei design depositati
- designazione
- nome e domicilio del depositante
- se del caso, nome e domicilio del designer
- nome e sede di un eventuale mandataro
- se del caso, indicazioni di priorità
- se del caso, descrizione del design
- numero d'ordine
- riproduzione del design

Depositi internazionali

I disegni e modelli depositati presso l'Organizzazione Mondiale della Proprietà Intellettuale a Ginevra con denominazione Svizzera godono della medesima protezione del deposito nazionale. Essi vengono pubblicati ogni volta nel foglio «Bulletin des dessins et modèles internationaux». Quest'organo di pubblicazione è da consultare se si vuole effettuare una ricerca completa.

Topografie

Le indicazioni concernenti le topografie di prodotti a semiconduttori depositati presso l'Istituto Federale della Proprietà Intellettuale sono menzionate nell'ordine seguente:

- numero di registrazione
- data del deposito
- designazione
- nome e domicilio del/la richiedente
- se del caso, nome e domicilio del/la produttore/trice
- nome e sede di un eventuale mandataro
- data e luogo di un'eventuale prima messa in circolazione della topografia

Hinterlegungen Dépôts Deposit

Cl. 09-03 131 935 12.07.2005
 8 Design – Dosen
 Hinterleger: Hoffmann Neopac AG, Eisenbahnstrasse 71,
 3602 Thun
 Designer: Thomas Liebe, Thun; Markus Fankhauser,
 Herbligen; Matthias Hammersen, Dinklage; Martin Presche,
 Lohne; Holger Hagen, Lohne
 Vertreter: Advokaturbüro Beutler Künzi Stutz, 3000 Bern 6
 Ende aufgeschobene Publikation

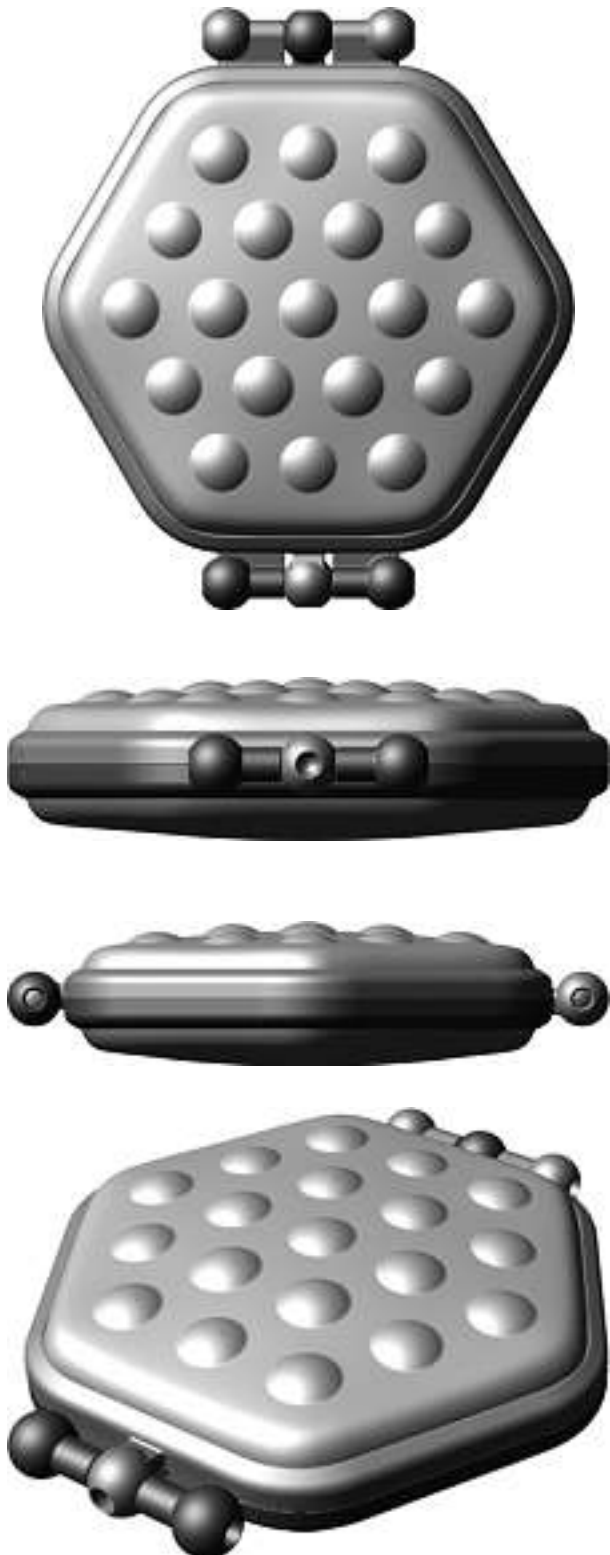

1





2

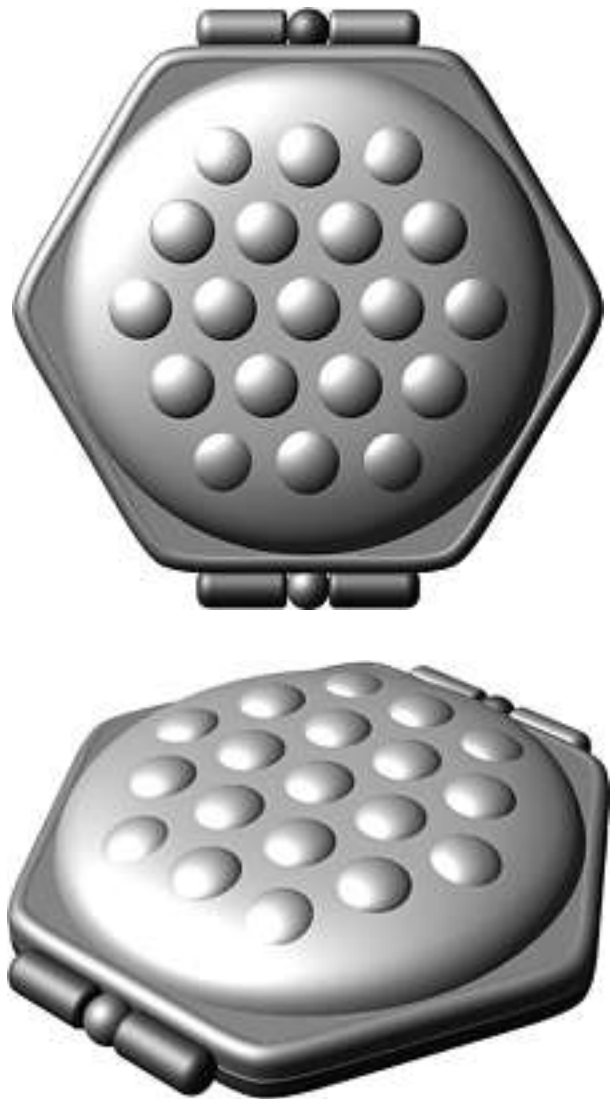

3

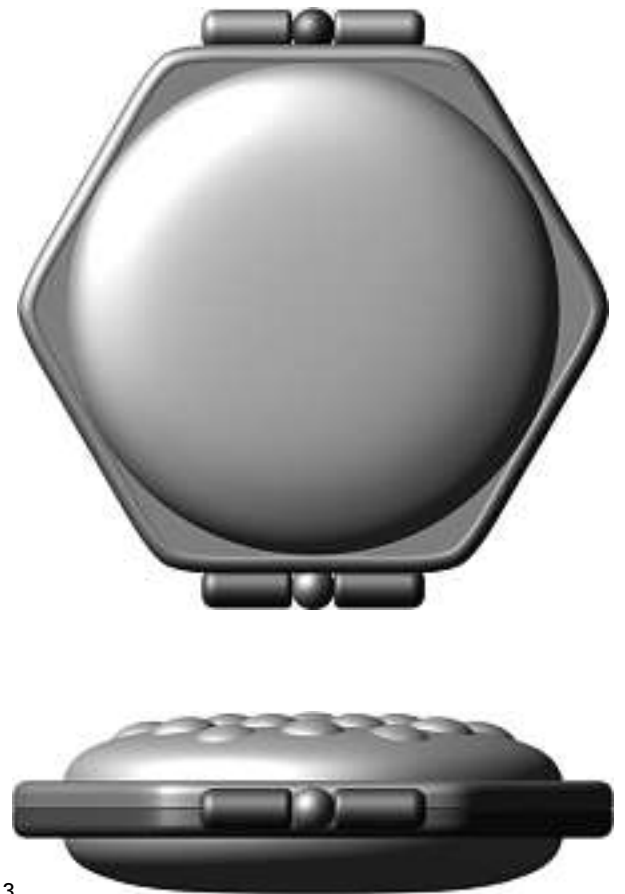



4





5



6



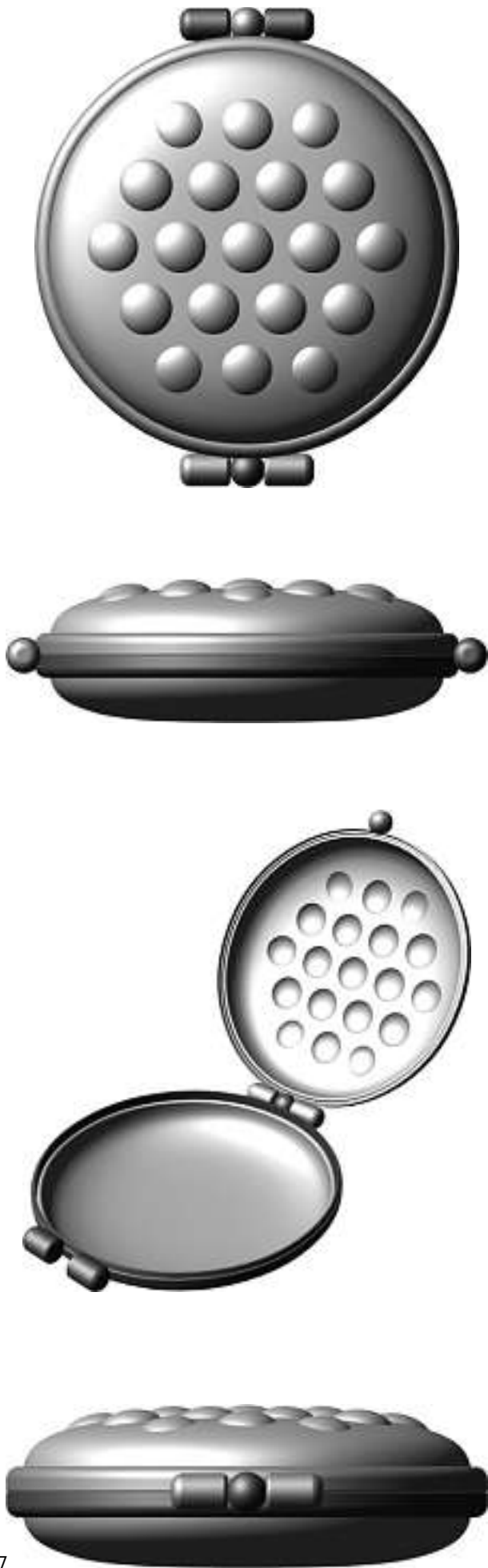



8

Cl. 11-01 132 127 13.09.2005
 1 design – bijoux
 Déposant: Robert Jaccard, Place du Temple 4, 1227 Carouge
 Mandataire: Bugnion S.A., 1211 Genève 12 - Champel
 Fin de la période ajournement de la publication



1

Cl. 28-01 132 376 28.11.2005
 4 Design – Tabletten
 Hinterleger: Nycomed Pharma AS, Drammensveien 852,
 P.O. Box 205, 1372 Asker, NO
 Designer: Carsten Martini Nielsen, Søborg; Peder Mohr
 Ohlsen, Kr. Hyllinge
 Vertreter: A. Braun, Braun, Héritier, Eschmann AG,
 Patentanwälte, 4051 Basel
 Priorität: EM, 30.05.2005
 Ende aufgeschobene Publikation

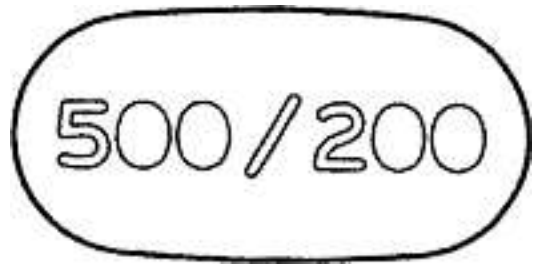
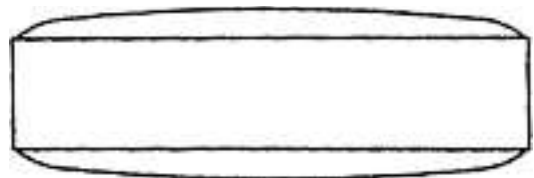

1

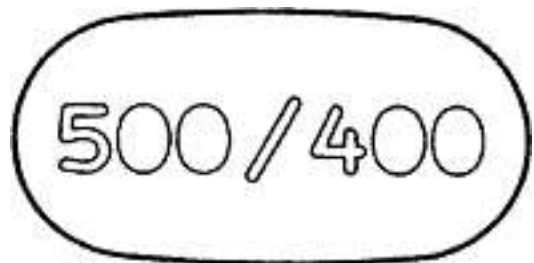
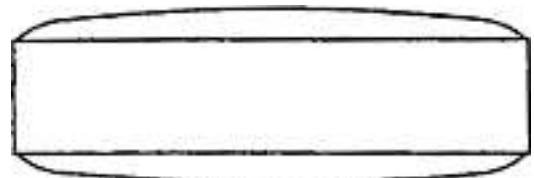

2

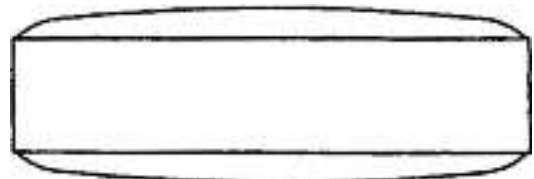

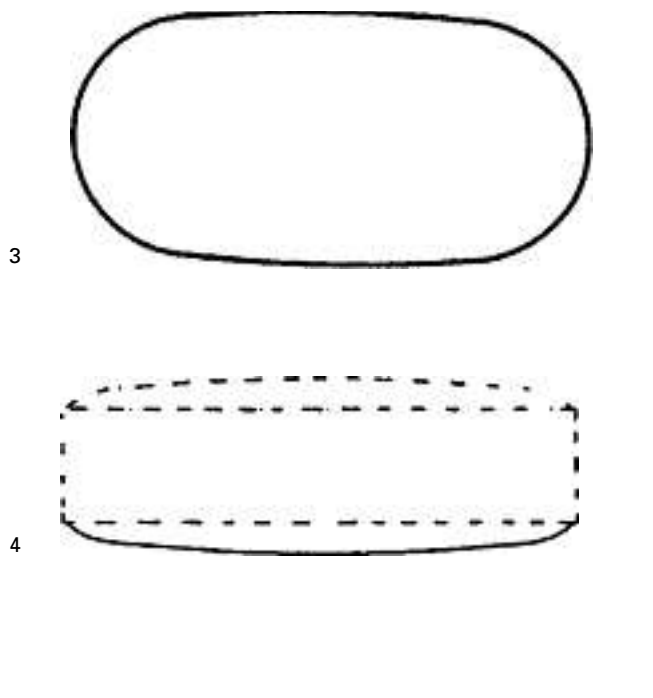

Cl. 12-08 **132 530** 12.01.2006
 1 design – automobile
 Depositante: Honda Motor Co., Ltd., No. 1-1, 2-chome,
 Minami-aoyama, Minato-ku, Tokyo, JP
 Designer: Daisuke Sawai, Saitama; Naoya Ishikura, Saitama;
 Deane James, Saitama
 Mandatario: Fiammenghi-Fiammenghi, 6900 Lugano
 Priorità: JP, 22.07.2005
 Fine del periodo di differimento della pubblicazione



467

Cl. 26-06 **132 538** 12.01.2006
 2 design – gruppi ottici anteriori e posteriori per autovettura
 Depositante: Honda Motor Co., Ltd., No. 1-1, 2-chome,
 Minami-aoyama, Minato-ku, Tokyo, JP
 Designer: Naoya Ishikura, Saitama; Deane James, Saitama
 Mandatario: Fiammenghi-Fiammenghi, 6900 Lugano
 Priorità: JP, 13.07.2005; JP, 13.07.2005
 Fine del periodo di differimento della pubblicazione



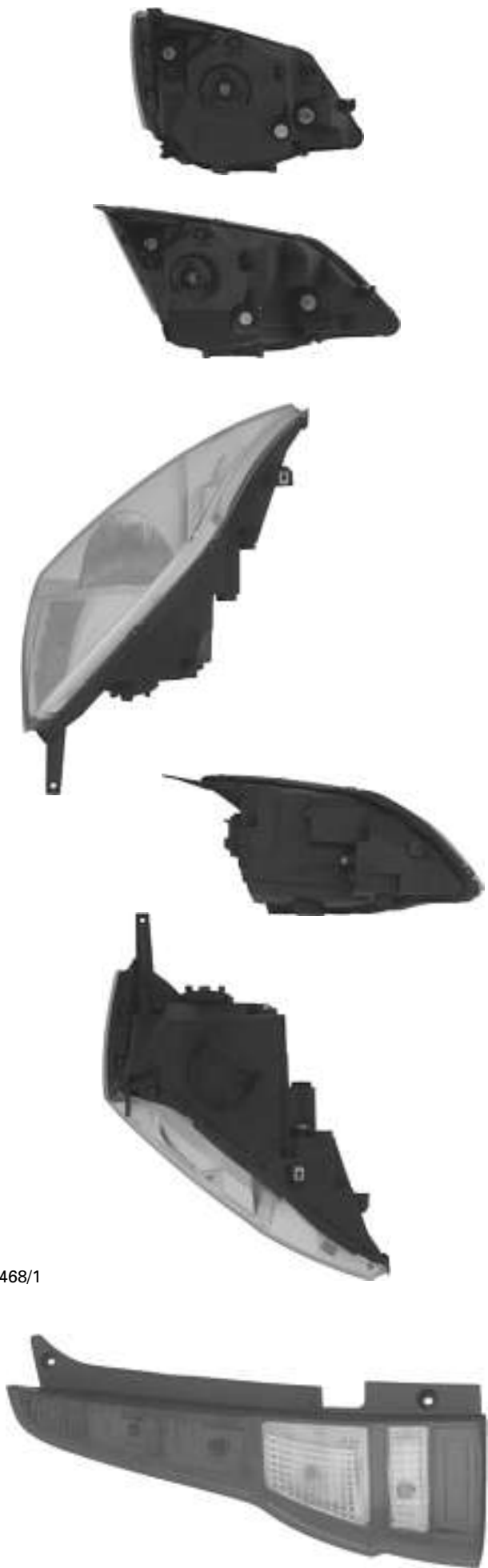

468/1





468/2

Cl. 09-03 132 559 25.01.2006

1 Design – Lebensmittelbehälter
 Hinterleger: Hilcona Aktiengesellschaft, Bendererstrasse 21,
 9494 Schaan, LI
 Designer: Jürgen Hilti, Schaan
 Vertreter: A.W. Metz & Co. AG, 8024 Zürich
 Priorität: EM, 13.10.2005
 Ende aufgeschobene Publikation

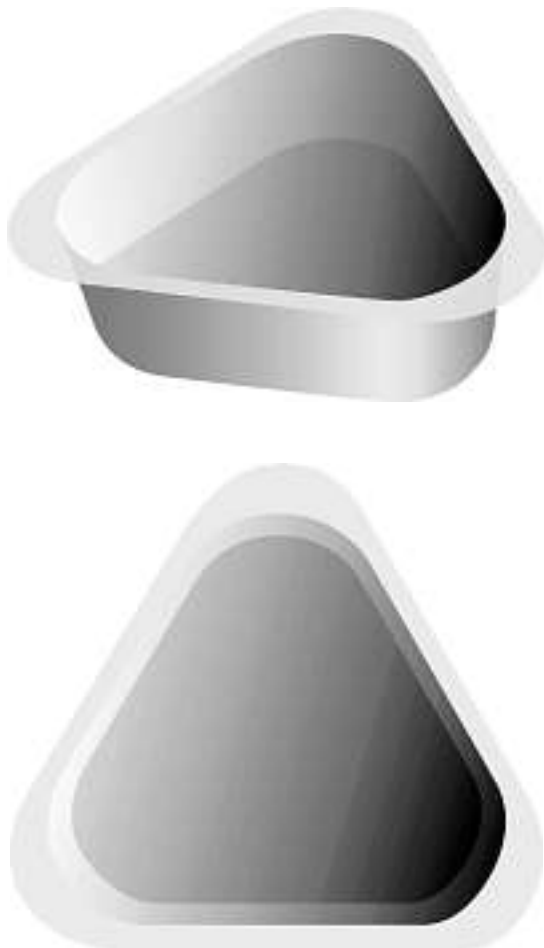

467-CH-9-DD

Cl. 10-02 132 644 15.03.2006

1 design – montre-bracelet
 Déposant: Luxury Timepieces International SA,
 Ch. des Rochettes 2, 2016 Cortaillod
 Designer: Frida Giannini, Firenze
 Mandataire: Inteltech SA, 2001 Neuchâtel
 Fin de la période ajournement de la publication





Harper

Cl. 02-04 **134 703** 29.10.2007
 8 Design – Schienbeinschützer
 Hinterleger: Task Force Properties & Investments Ltd.,
 Millennium House, Moss Road, Witham, Essex CM8 3 UQ, GB
 Designer: Harald Scheffer, Merzig
 Vertreter: A.W. Metz & Co. AG, 8024 Zürich
 Priorität: EM, 30.04.2007; EM, 30.04.2007; EM, 30.04.2007;
 EM, 30.04.2007

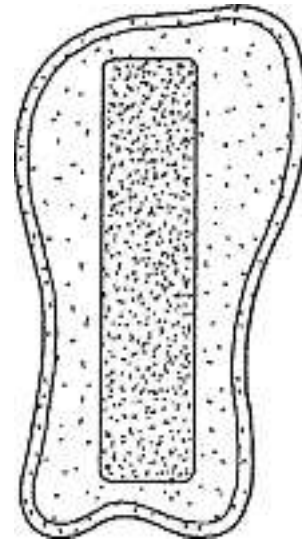

1

Cl. 01-01 **134 702** 23.01.2008
 1 Design – Lebensmittel
 Hinterleger: Thomas Walter Siegrist, Sonnenbergstrasse 51,
 5408 Ennetbaden

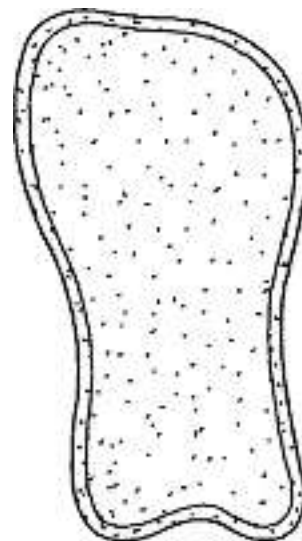

1

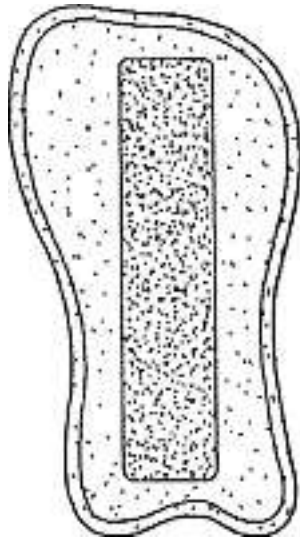

3

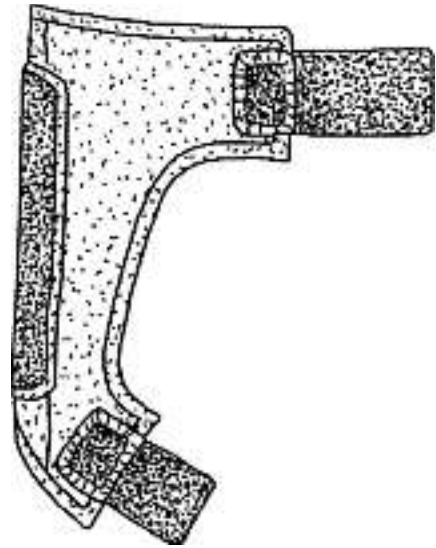

2

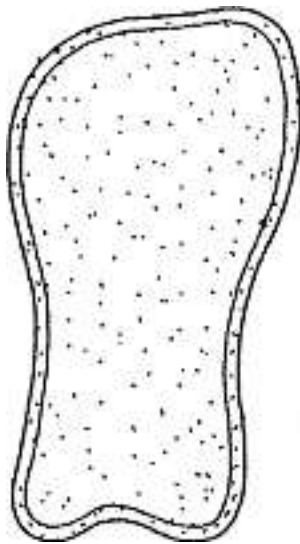

4

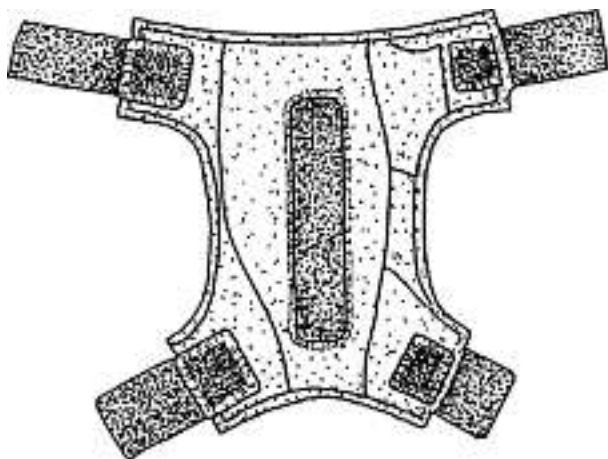
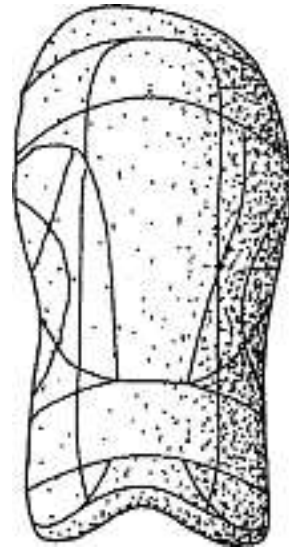

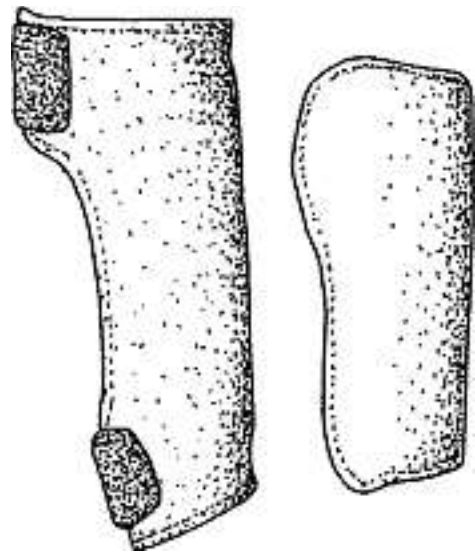
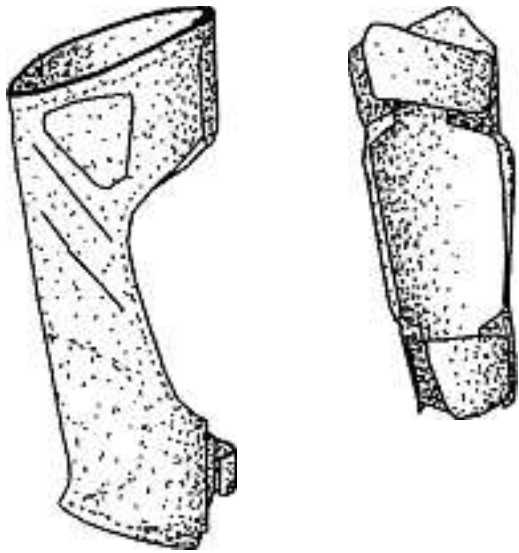

6

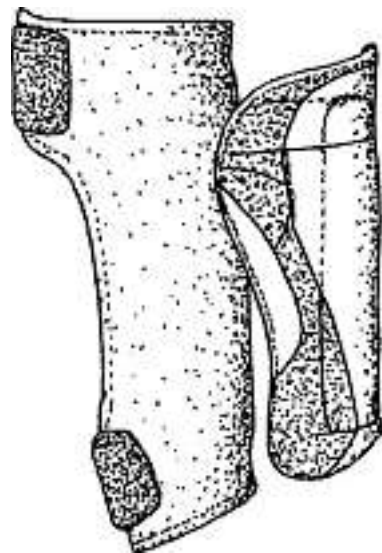
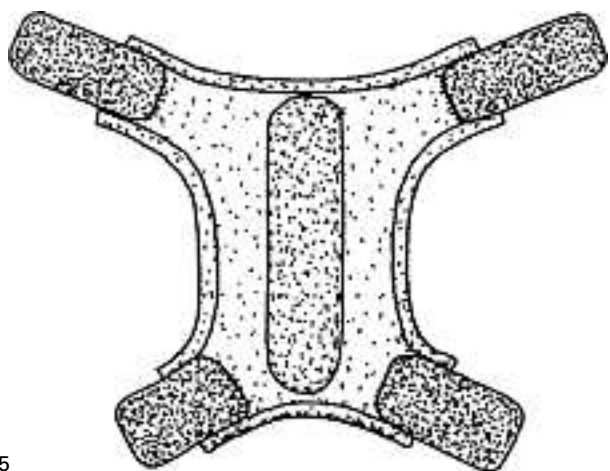
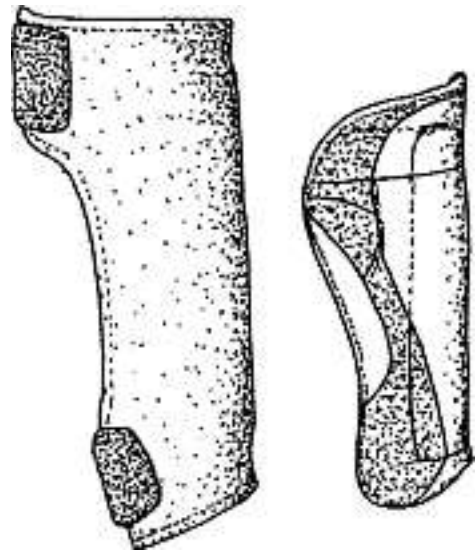
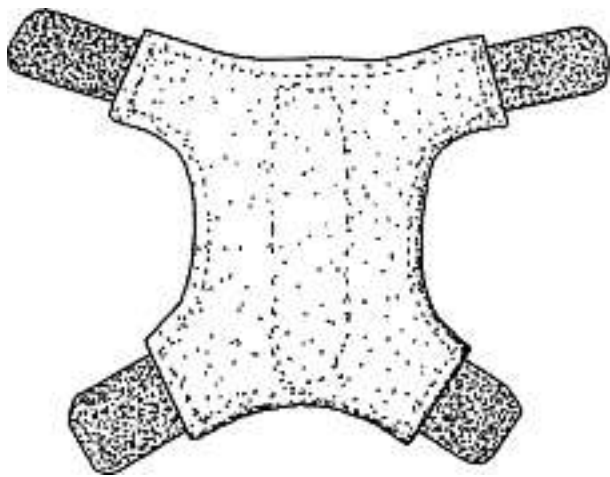

5

7

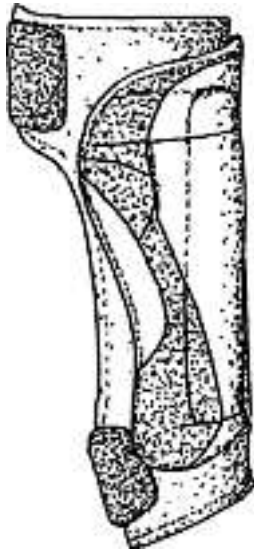

8

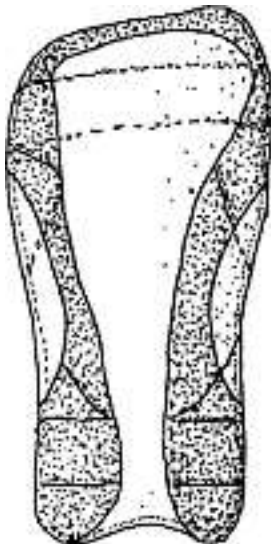

Cl. 02-04 **134 704** 24.01.2008
 3 Design – Schuhe
 Hinterleger: Crocs, Inc., 6328 Monarch Park Place, Niwot, CO,
 US
 Designer: Stefano del Biondi, Noventa Padovana;
 Marianna Zuin, Villatora di Saonara; Alessio Zagallo,
 Rosara di Codevigo
 Vertreter: Keller & Partner Patentanwälte AG, 3000 Bern 7
 Priorität: US, 27.07.2007





1



2





3

Cl. 03-01 134 705 04.01.2008

1 Design – Kärtchen-Box

Hinterleger: VSB Verlag für Schule und Beruf,
Oswald Leitner, Largitzenstrasse 33, 4056 Basel

Designer: Markus Meyer, Binningen; Bengt Sprinzl, Wien

Beschreibung des Designs: Form: Die think&click-Kartonbox besteht aus einem Aussenteil, der an vier Punkten verklebt wird, und einem Innenteil, der lose eingeschoben wird. Beim Schliessen der Kartonbox entsteht ein deutliches Klickgeräusch. Layout: Die Vorderseite trägt an der oberen linken Ecke eine Wort-Bild-Marke in Form eines Dreiecks, das sich über die linke und obere Schmalseite in Form von zwei Dreiecken weiterzieht. Die Rückseite trägt an der unteren linken Ecke eine Wort-Bild-Marke in Form eines Dreiecks, das sich über die linke und untere Schmalseite in Form von zwei Dreiecken weiterzieht.



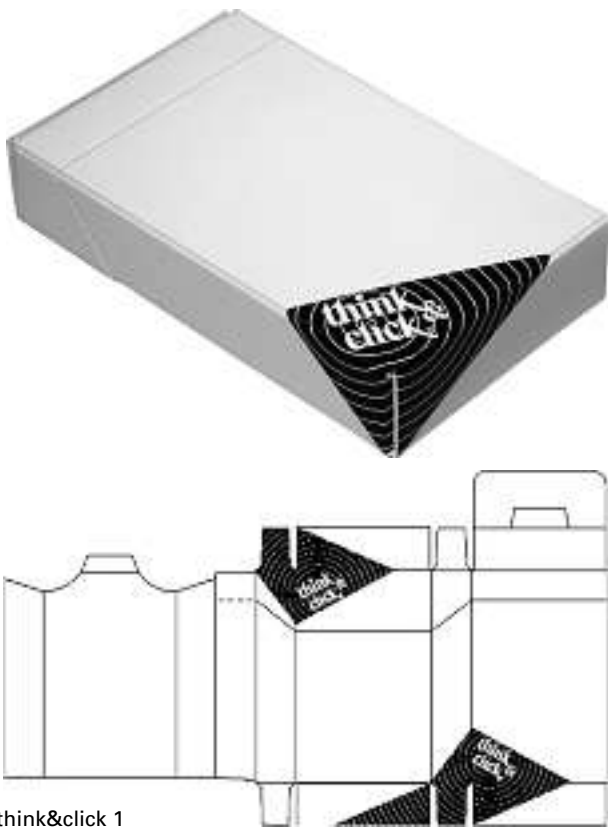

think&click 1

Cl. 03-01 134 706 17.01.2008
 1 design – sac
 Déposant: Marie-Josée Clamy Boccard, 60, rue des Lattes,
 1217 Meyrin

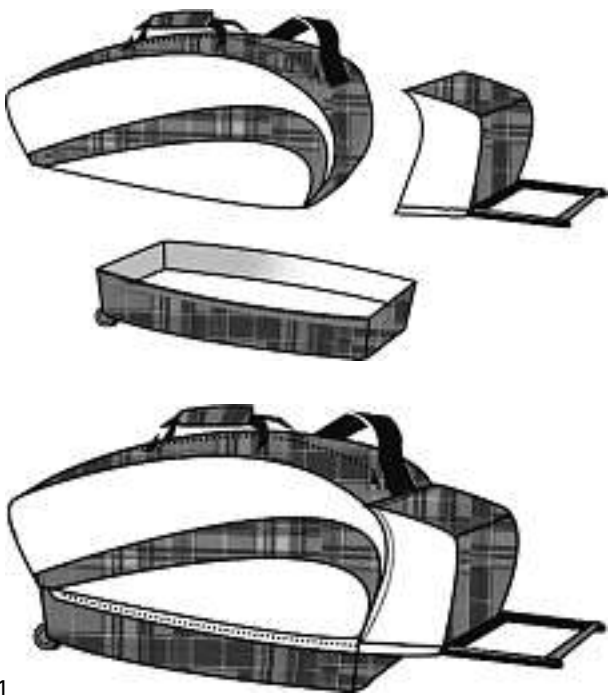

1

Cl. 04-02 134 707 23.01.2008
 5 Design – Zahnbürstengriff
 Hinterleger: Braun GmbH, Frankfurter Strasse 145,
 61476 Kronberg, DE
 Designer: Michaela Pusch, Usingen; Björn Kling, Glashütten;
 Andreas Birk, Kronberg; Lucy Abigail Zimmermann,
 Kronberg; Casey Gustafson, Iowa City; Todd Borgerson,
 Mason
 Vertreter: Servopatent GmbH, 8125 Zollikerberg
 Priorität: US, 27.07.2007

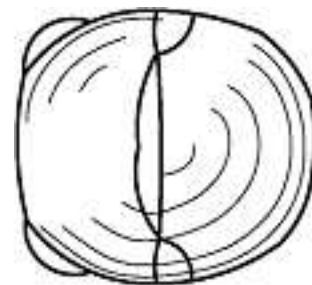
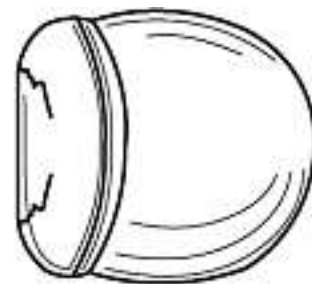
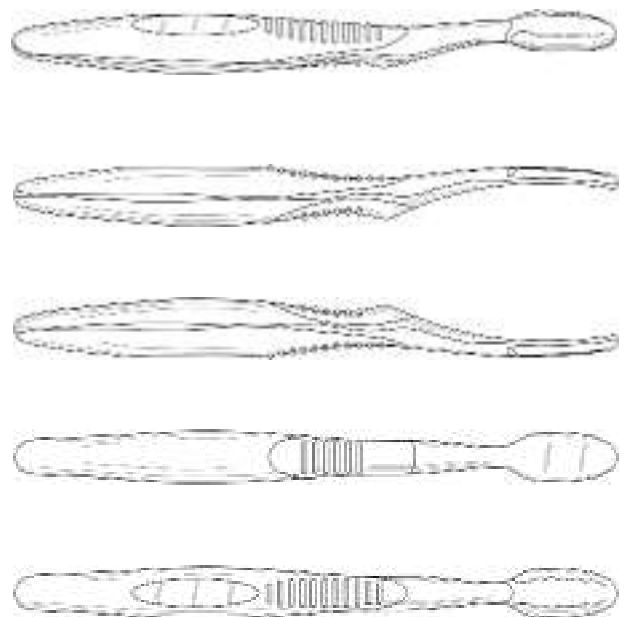

1

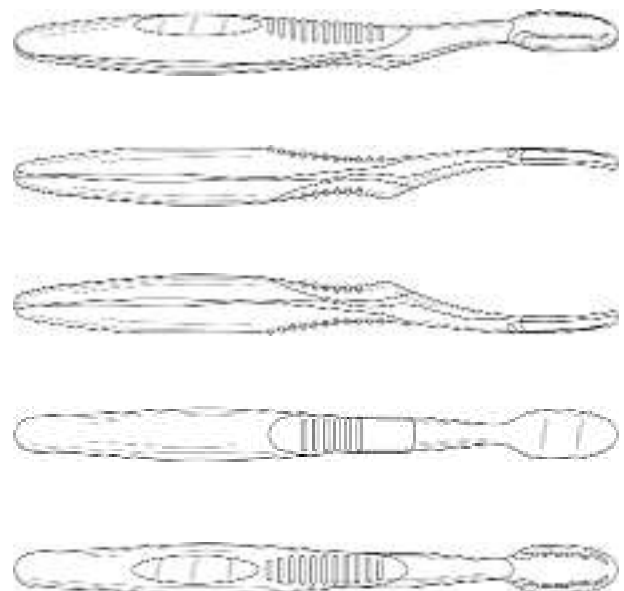

2

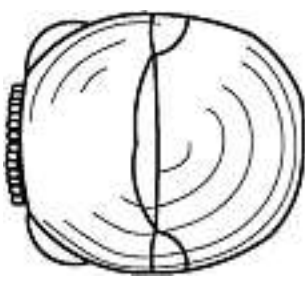
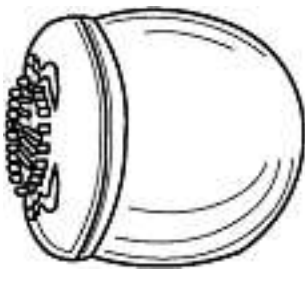
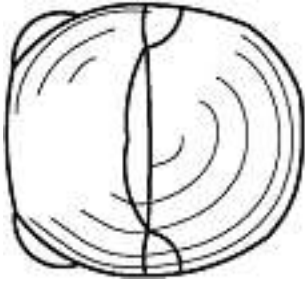
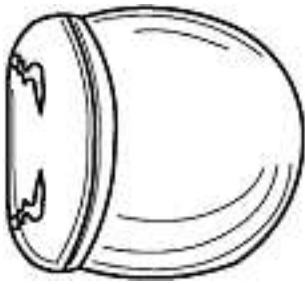

3

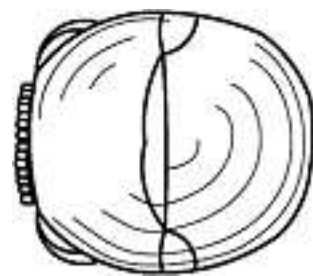

4



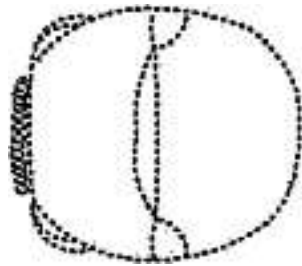
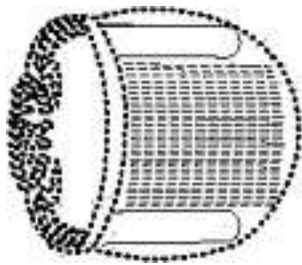
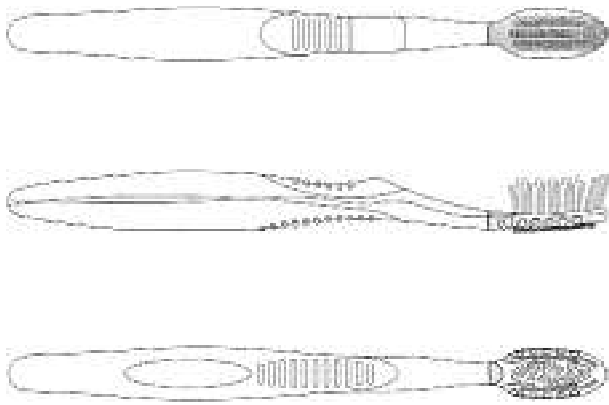

5

Cl. 05-05 **134 708** 22.01.2008
 1 Design – Bemusterung für Textilien
 Hinterleger: Oliver Huser, Höhenweg 562, 4717 Mümliswil

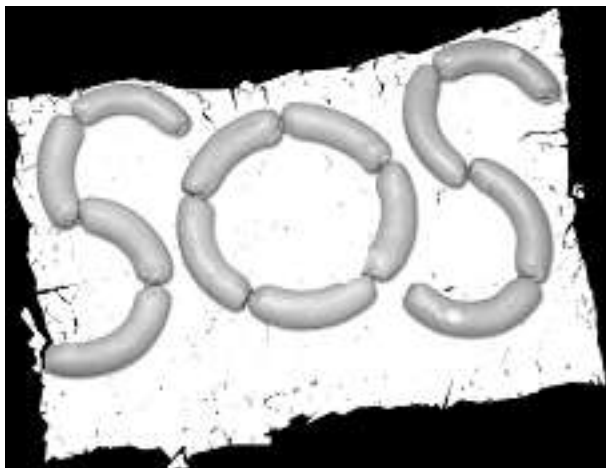

sos

Cl. 05-06 **134 709** 17.01.2008
 1 design – papier toilette
 Déposant: Georgia-Pacific France, 11, route Industrielle, 68320 Kunheim, FR
 Designer: Donald Barredo, Ingersheim; Jean-Bernard Kuehn, Bennwihr
 Mandataire: MICHELI & CIE SA, 1226 Thônex
 Priorité: EM, 20.07.2007



15191A

Cl. 06-01, 06-02, 06-05 **134 710** 22.01.2008
 7 Design – Sessel, Sofas, Hocker/Tisch, Bett
 Hinterleger: Bise.com GmbH, Europa Center 13. OG, 10789 Berlin, DE
 Designer: Giuseppe Vigano, Lissone
 Vertreter: Wartmann & Merker, 8022 Zürich
 Priorität: EM, 02.08.2007





States-Sessel-XL



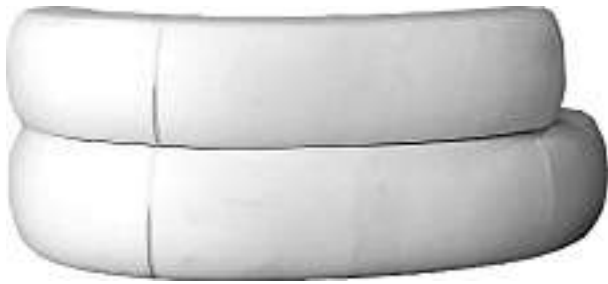

States-Sofa-klein



States-Sofa-mittel





States-Bett





States-Dormeuse

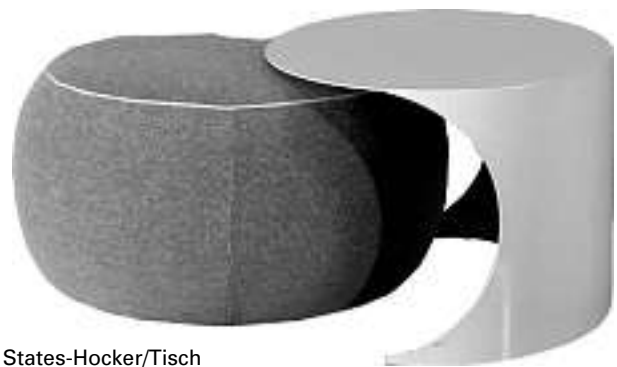

States-Hocker/Tisch



States-Dormeuse mit Hocker/Tisch

Cl. 06-03 134 711 15.01.2008
 2 design – table
 Déposant: Laetitia Voirol, Rue de Boujean 161, 2504 Bienne



up



crouch

Cl. 06-06 134 712 22.01.2008
 4 Design – Raumteiler
 Hinterleger: Rolf Benz AG & Co. KG, Haiterbacher Strasse 104, 72202 Nagold, DE
 Designer: Sebastian Labs, Nagold; Nadine Müller, Nagold; Mario Sasse, Nagold
 Vertreter: Bovard AG, 3000 Bern 25
 Priorität: EM, 17.09.2007; EM, 17.09.2007; EM, 17.09.2007; EM, 17.09.2007

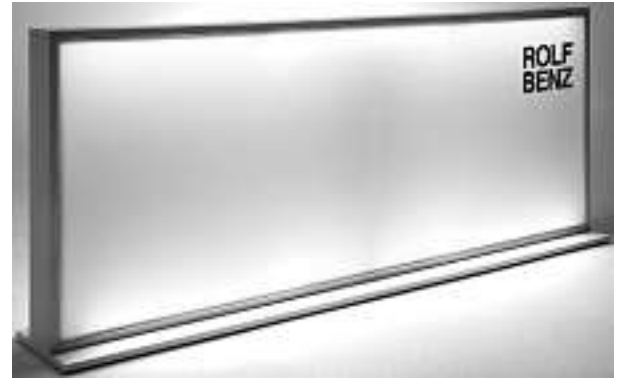
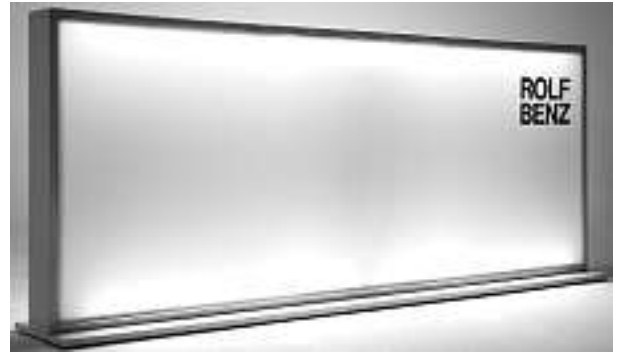

300641-1

300641-2

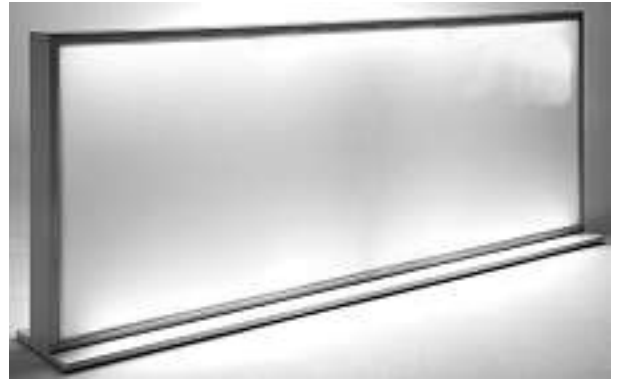
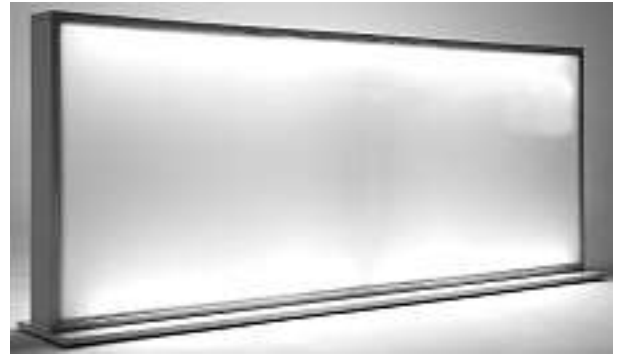

300641-4



300641-3

Cl. 07-02 **134 713** 11.01.2008
 1 Design – Caquelon
 Hinterleger: Michael Steinlin, Alte Speicherstrasse 2615,
 9053 Teufen AR





CA1

Cl. 07-06 **134 715** 21.12.2007
 1 design – support pour ustensiles de cuisine
 Déposant: Pierre-Alain Urfer, Chemin du Château 3,
 1443 Champvent; Paul-Marie Buhler, Chemin de la
 Musardière 11, 1131 Tolochennaz
 Mandataire: Lemman Consulting S.A., 1260 Nyon



1

Cl. 07-06 **134 716** 23.01.2008
 1 Design – Gewürzstreuer
 Hinterleger: Peter Meyer, Chamerstrasse 44, 6300 Zug
 Vertreter: Industrieberatung Maier AG, 4450 Sissach





1

Cl. 08-05 134 717 16.01.2008

1 Design – Zangenkopf
 Hinterleger: TOPICO Handels-GmbH & Co. KG,
 Süderstrasse 259, 20537 Hamburg, DE
 Designer: Wing Hang Fung, Yangjian
 Vertreter: Isler & Pedrazzini AG, 8027 Zürich
 Priorität: EM, 17.07.2007

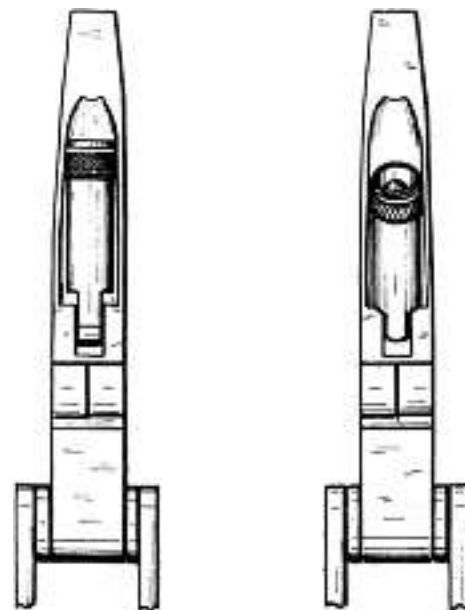
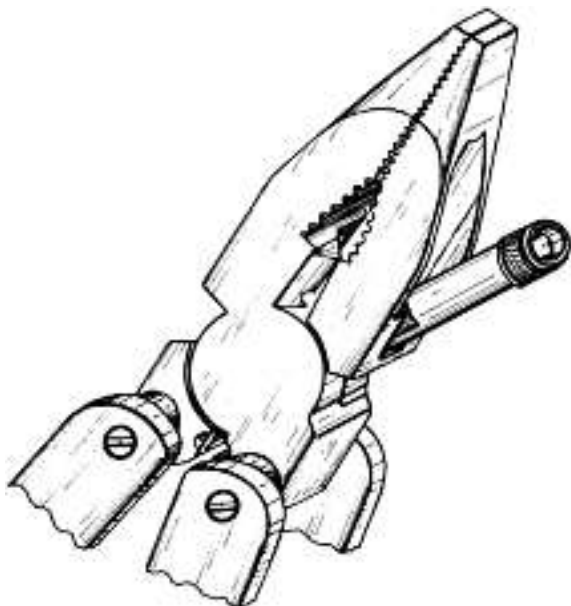
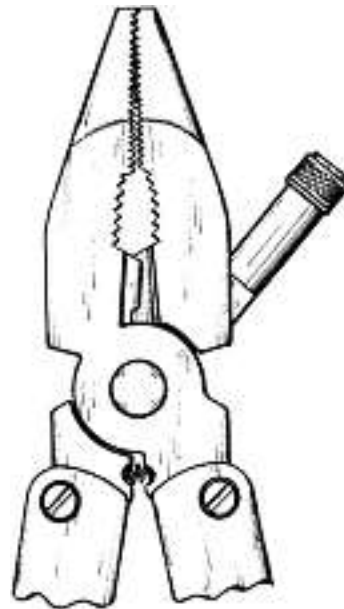
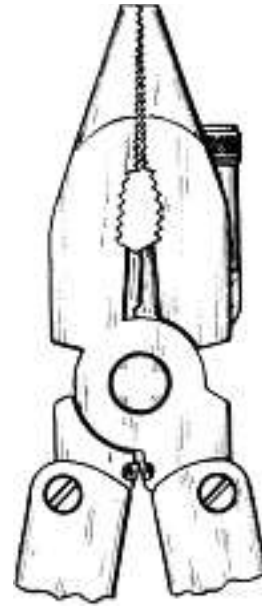

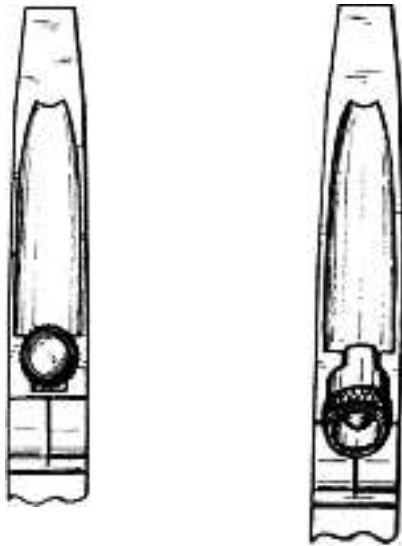

M13459



Cl. 08-08 **134 718** 21.01.2008
 1 Design – Rohrverschraubung
 Hinterleger: KULM Holding AG, Schützenstrasse 25,
 8355 Aadorf
 Designer: Christoph Bachmann, Rickenbach
 Vertreter: Georg Fischer AG, 8201 Schaffhausen

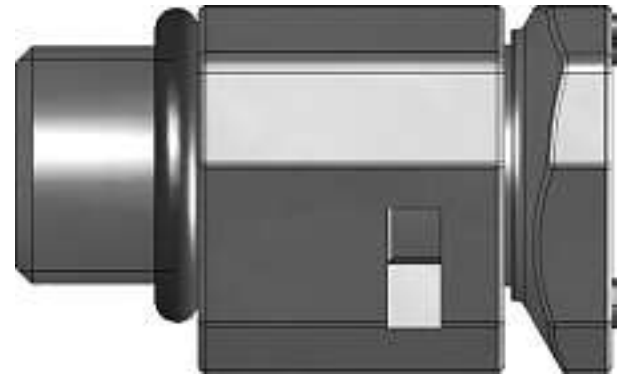



0344/SER CH

Cl. 09-01 **134 719** 21.01.2008
 1 Design – Teil einer Flasche
 Hinterleger: Oy Sinebrychoff Ab, Sinebrychoffinaukio 1,
 04250 Kerava, FI
 Designer: Rami Toivonen, Lahti
 Vertreter: A.W. Metz & Co. AG, 8024 Zürich
 Priorität: FI, 13.08.2007

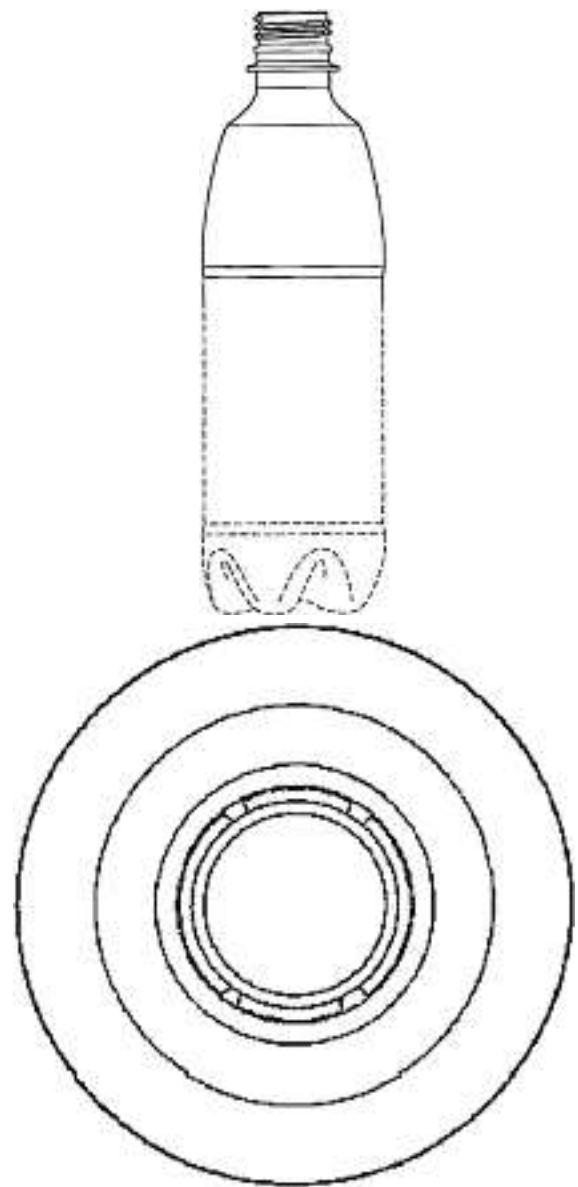

1

Cl. 09-01 **134 720** 21.01.2008
 1 Design – Teil einer Flasche
 Hinterleger: Oy Sinebrychoff Ab, Sinebrychoffinaukio 1,
 04250 Kerava, FI
 Designer: Rami Toivonen, Lahti
 Vertreter: A.W. Metz & Co. AG, 8024 Zürich
 Priorität: FI, 17.08.2007

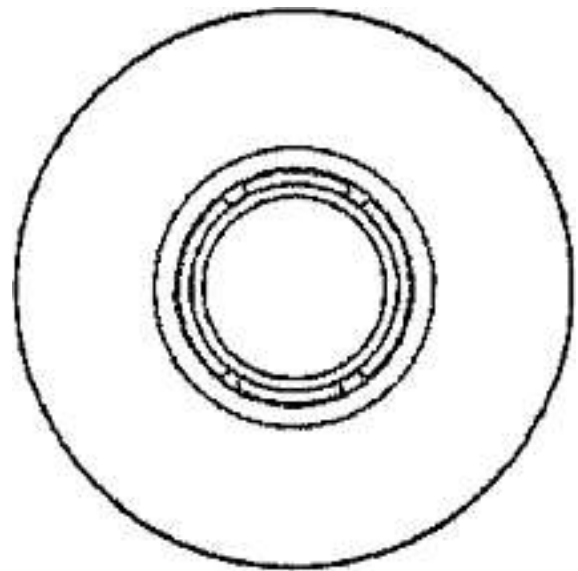



1

Cl. 09-03 134 721 03.01.2008
4 Design – Dosen
Hinterleger: Grether AG, Parkstrasse 5, 4102 Binningen
Designer: Artur Wichowski, Thun
Vertreter: lic. iur. Klaus Feger, Advokat, 4010 Basel



590-1374B





590-1376B

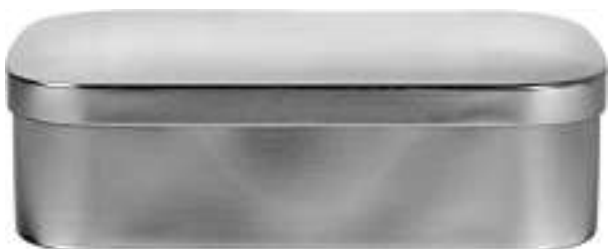

590-1378B



590-1380B

Cl. 09-03 134 722 21.01.2008
1 Design – Dose
Hinterleger: Flaigg AG, Langenhagstrasse 3, 4147 Aesch BL
Designer: Sören Wulf, Königstein

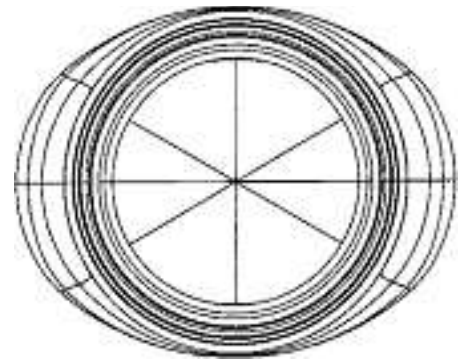

4078

Cl. 09-05 **134 723** 23.01.2008

4 Design – Beutel

Hinterleger: The Iams Company, 7250 Poe Avenue,
Dayton (OH 45414), US

Designer: George Scott Kerr, Mason; Lawrence Andrew
Schumacher, Trenton; Barry Stanley Shantz, Cincinnati

Vertreter: Servopatent GmbH, 8125 Zollikerberg
Priorität: US, 02.08.2007; US, 02.08.2007

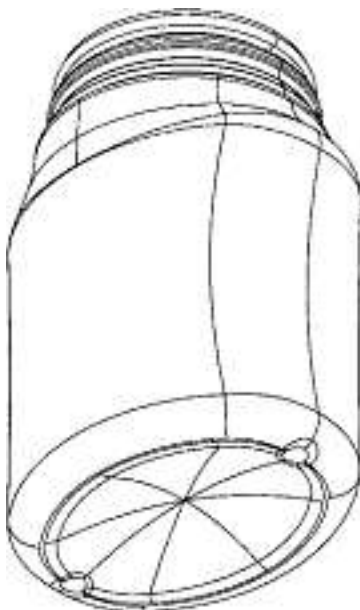
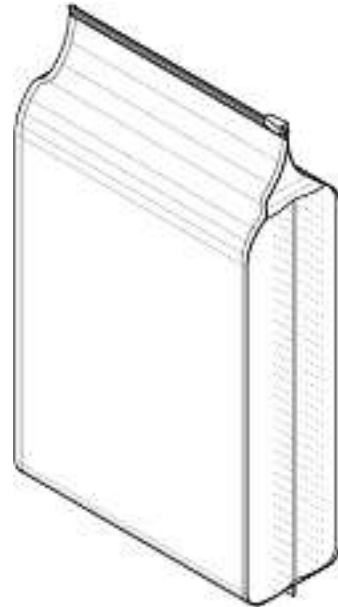
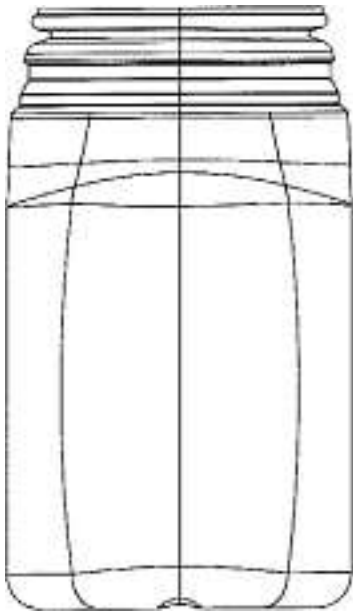

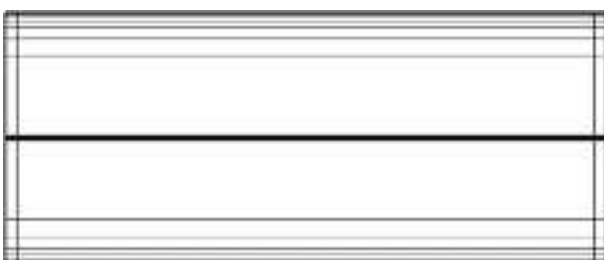
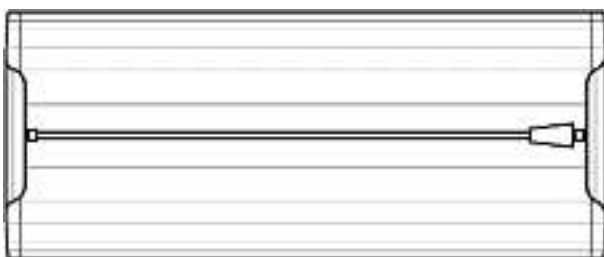
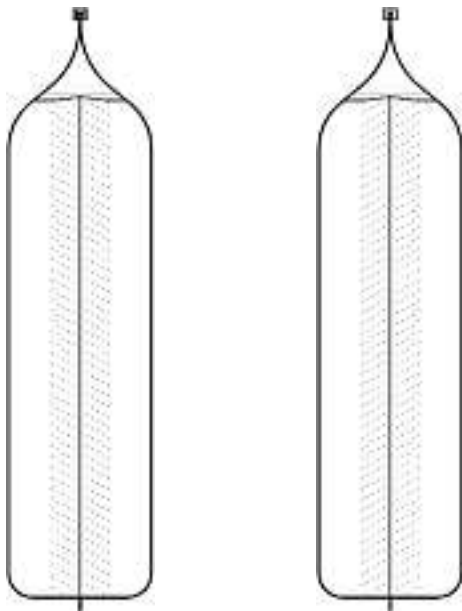
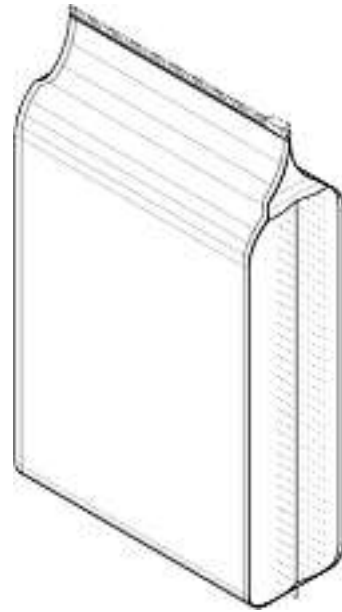

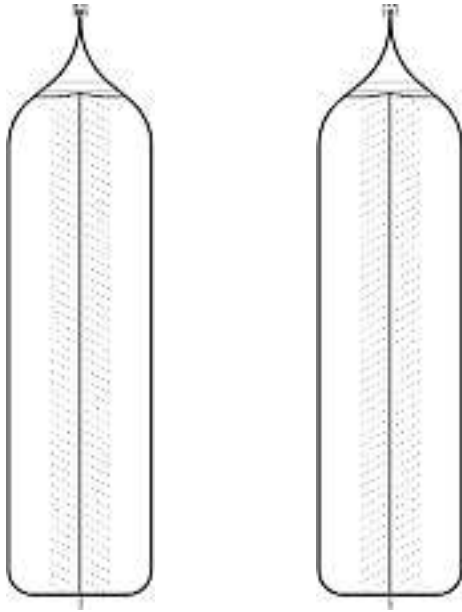

2

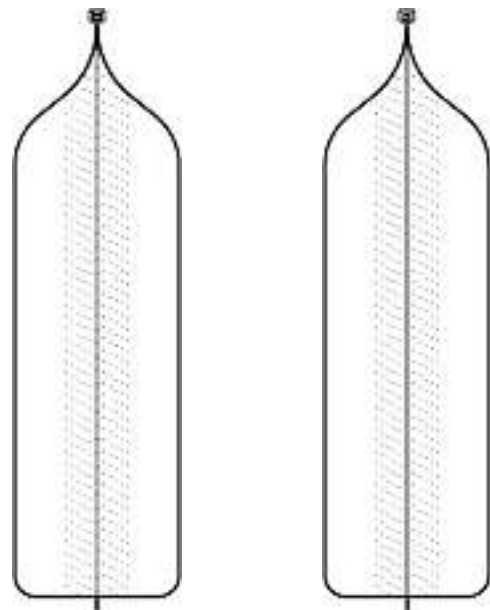
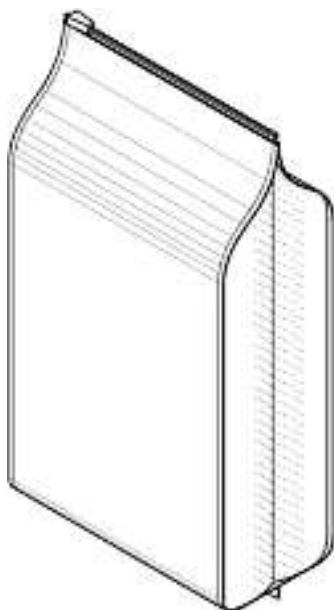

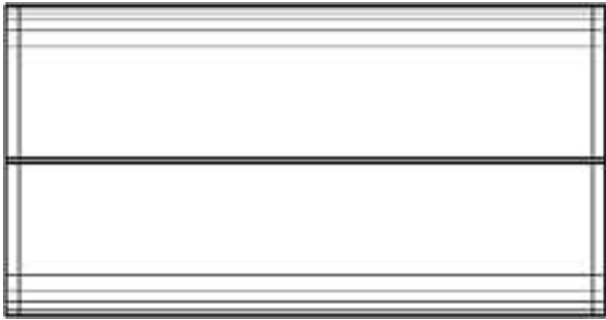
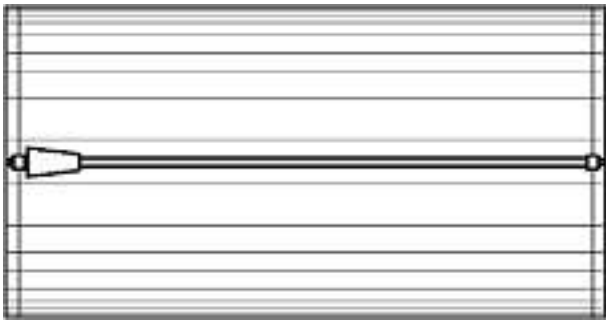

3

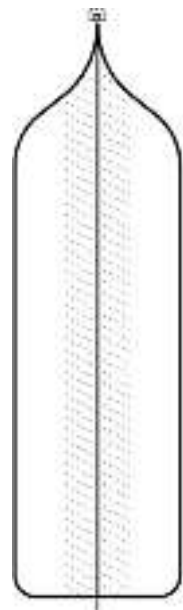
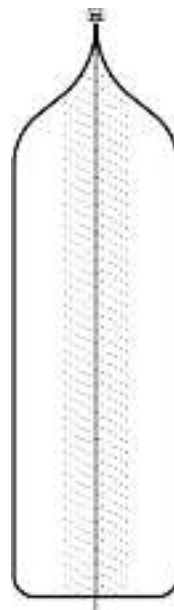
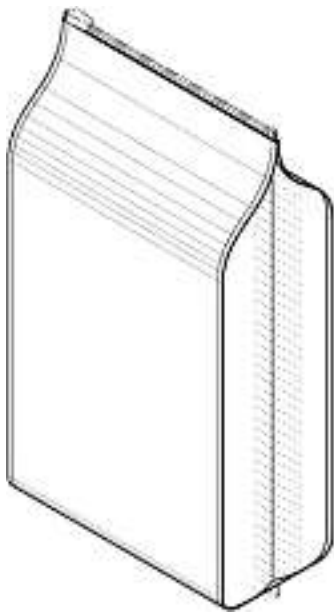

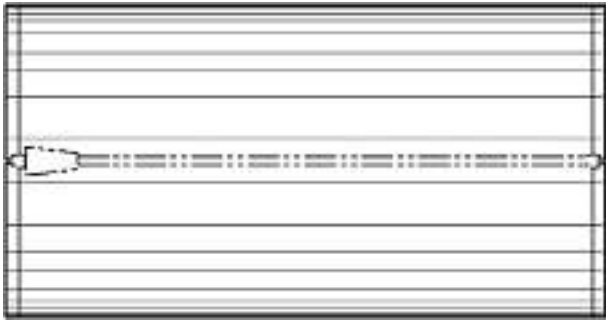

4

Cl. 10-02 134 724 21.12.2007
 1 design – montre-bracelet
 Déposant: CSDconsulting Sàrl, Rue du Borgeaud 12,
 1196 Gland
 Designer: Eddy Burgener, Le Landeron



B01R

Cl. 10-02 134 725 27.12.2007
 1 design – montre-bracelet
 Déposant: CSDconsulting Sàrl, Rue du Borgeaud 12,
 1196 Gland
 Designer: Eddy Burgener, Le Landeron



B01RL

Cl. 10-02, 10-07 134 726 14.01.2008
 29 Design – Uhrengehäuse, Uhrenarmbänder, Zifferblätter,
 Armbanduhren
 Hinterleger: FESTINA LOTUS, S.A., Via Layetana, 20-4a,
 08003 Barcelona, ES
 Designer: Miguel Rodriguez, Barcelona
 Vertreter: Isler & Pedrazzini AG, 8027 Zürich
 Priorität: EM, 13.07.2007

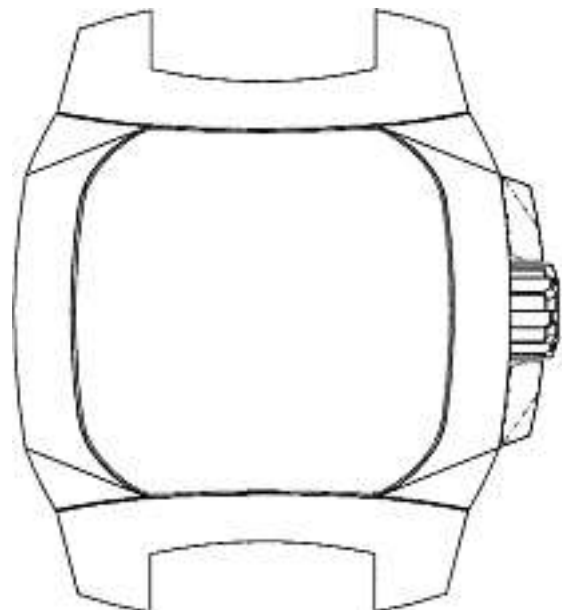
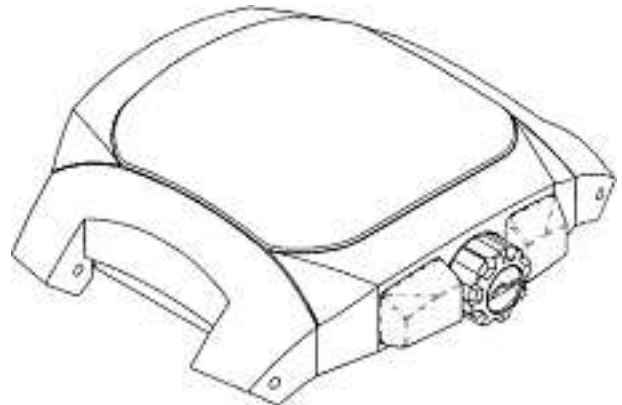

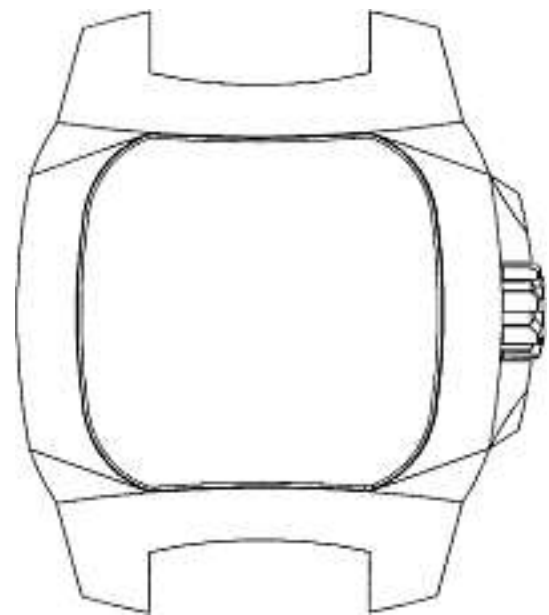
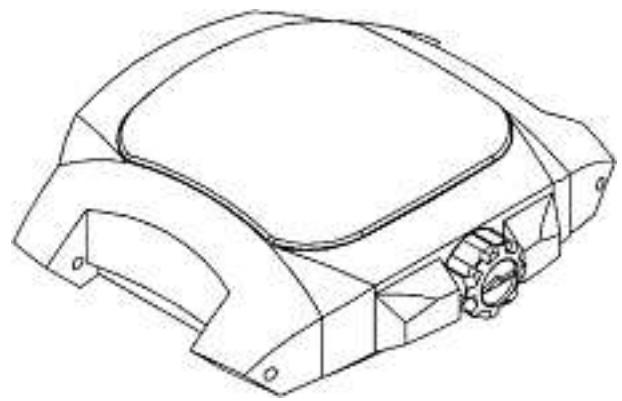
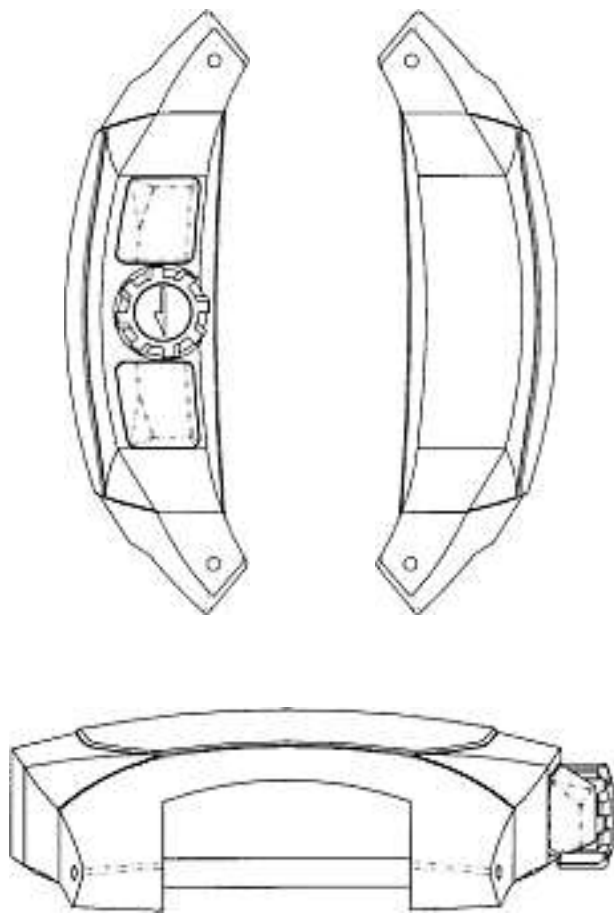

M13458-01

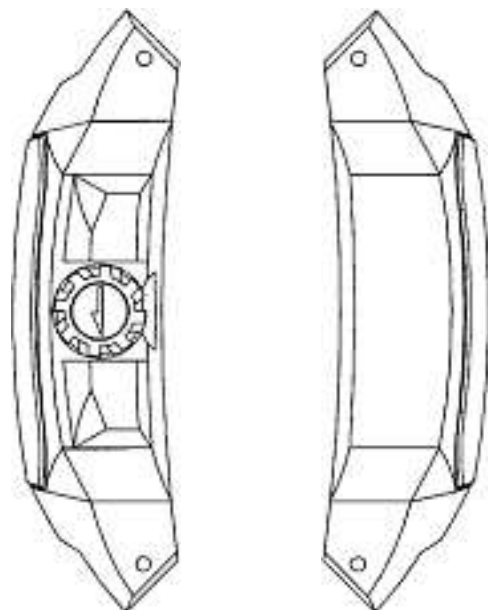
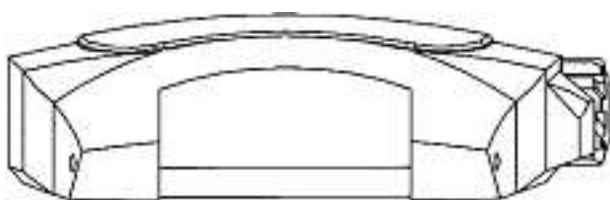



M13458-02

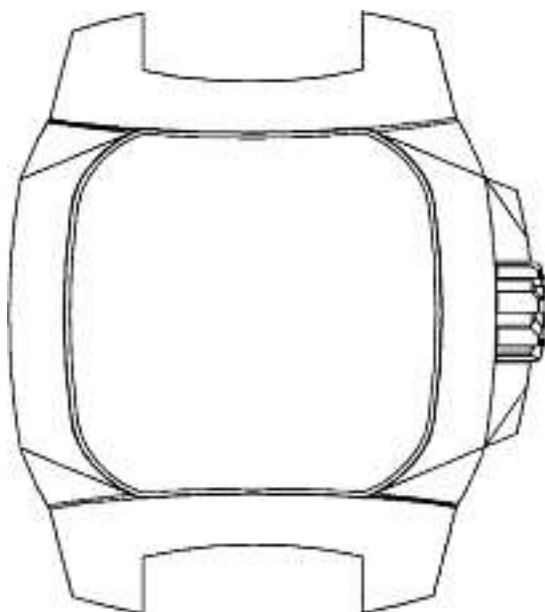
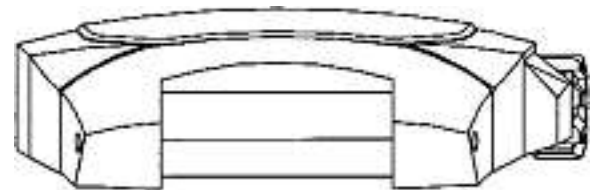
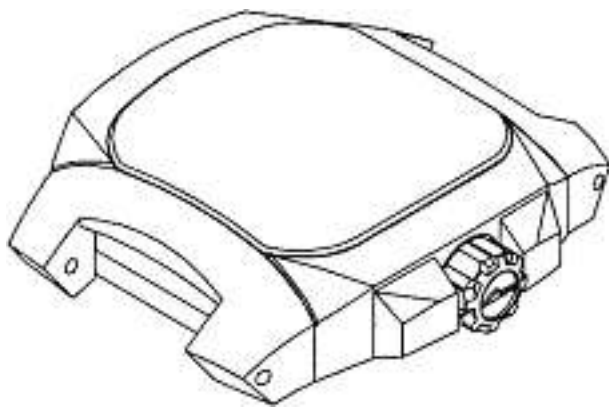
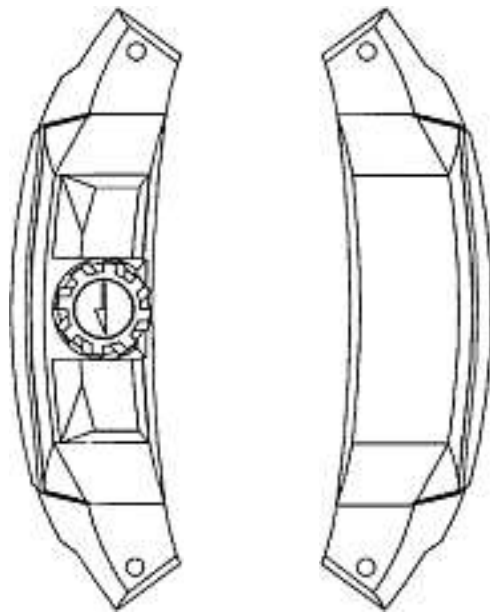

M13458-03

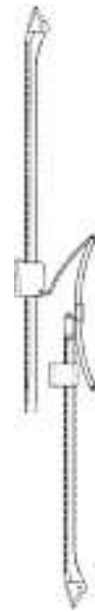

M13458-05



M13458-04

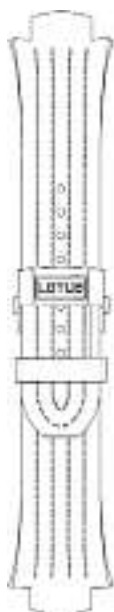

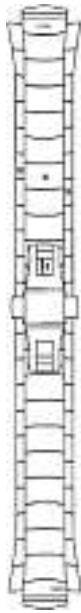
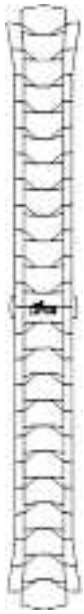

M13458-07

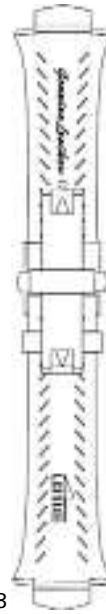
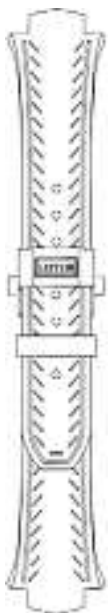

M13458-08



M13458-09



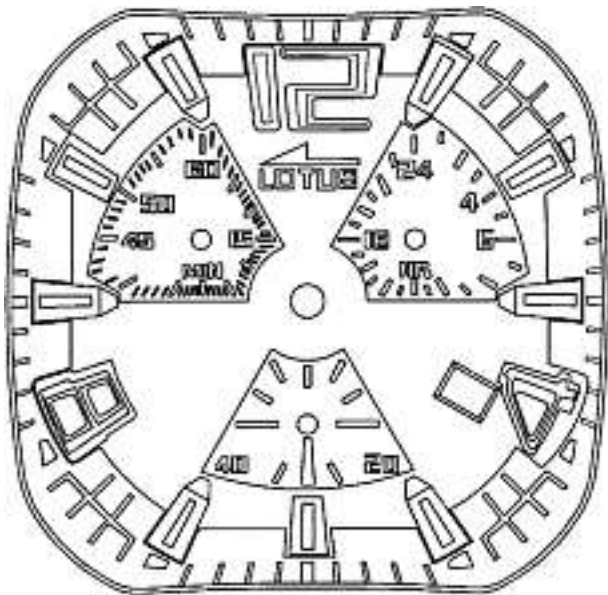

M13458-10

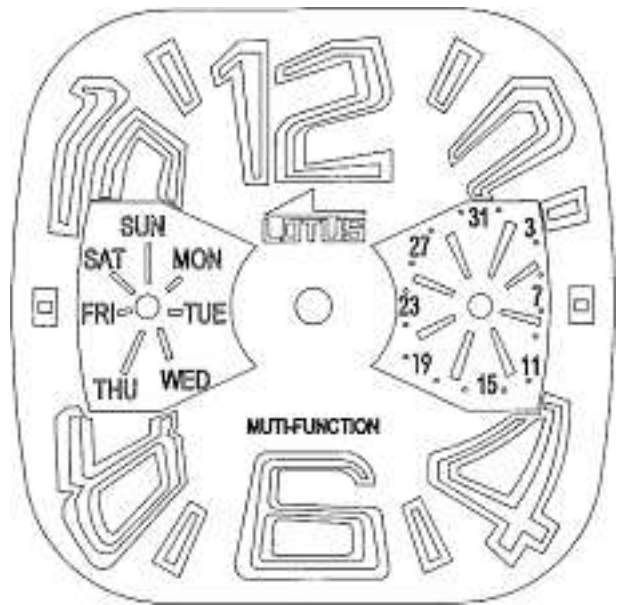

M13458-13

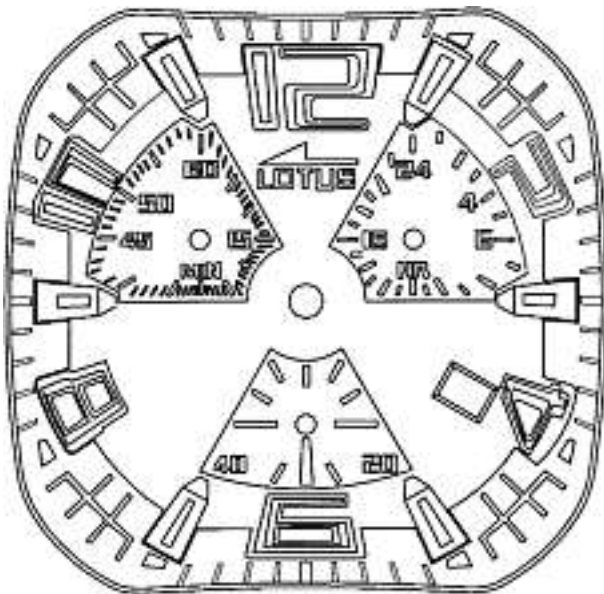

M13458-11



M13458-14

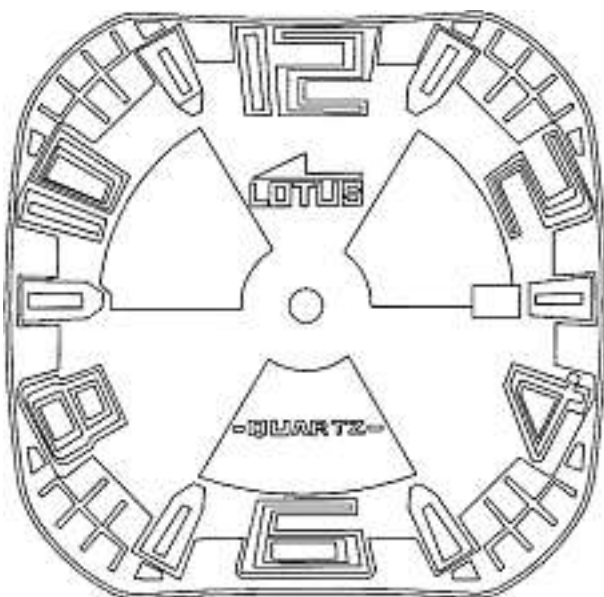

M13458-12

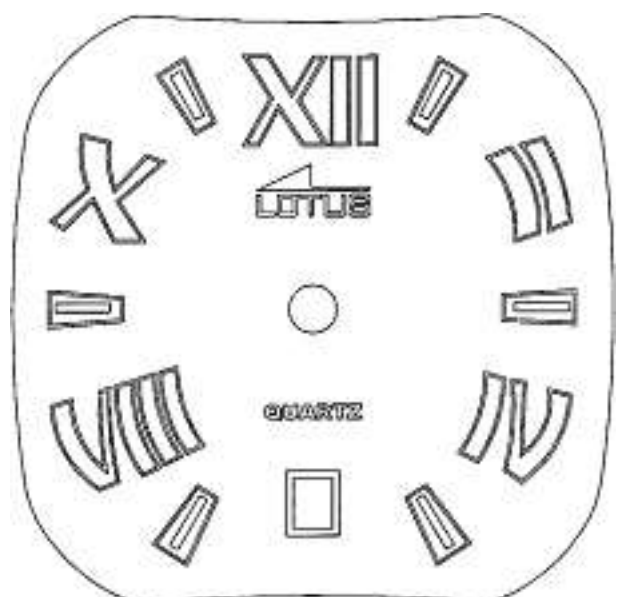

M13458-15

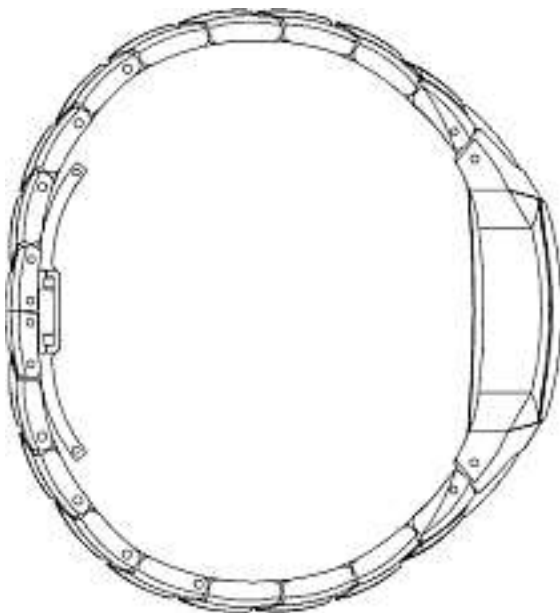
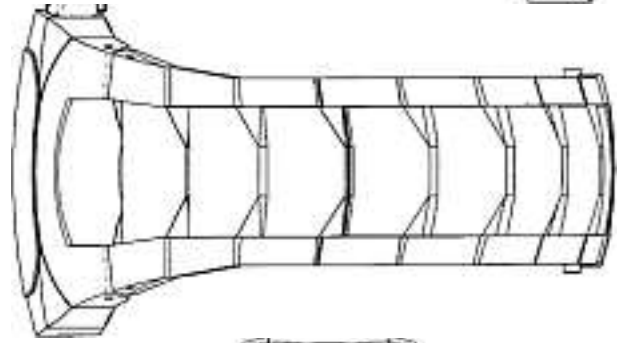
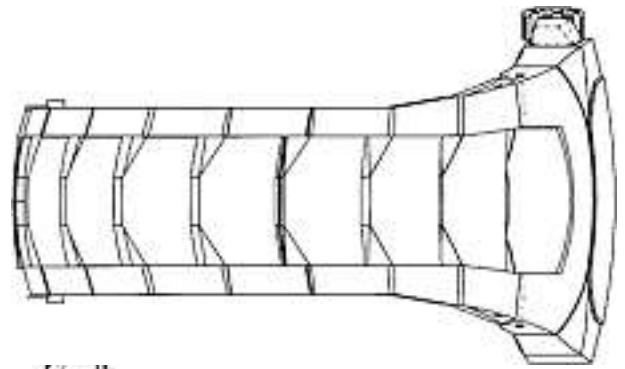

M13458-16

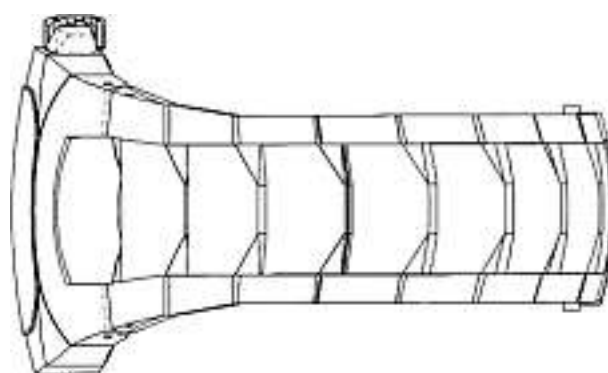
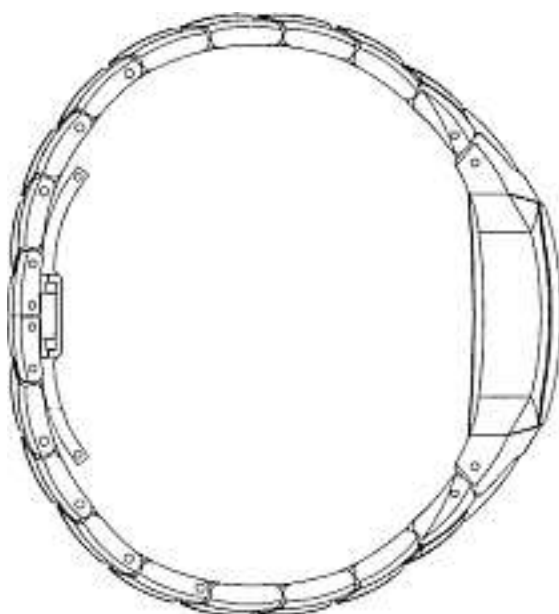
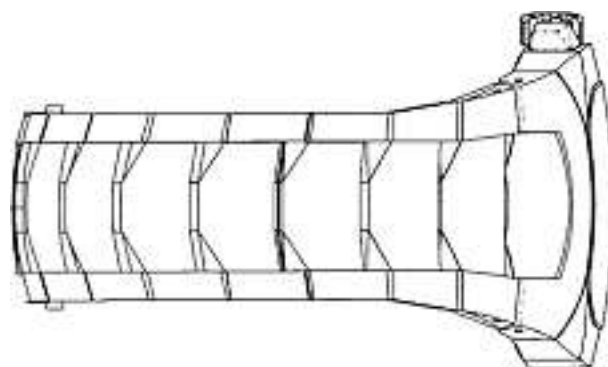

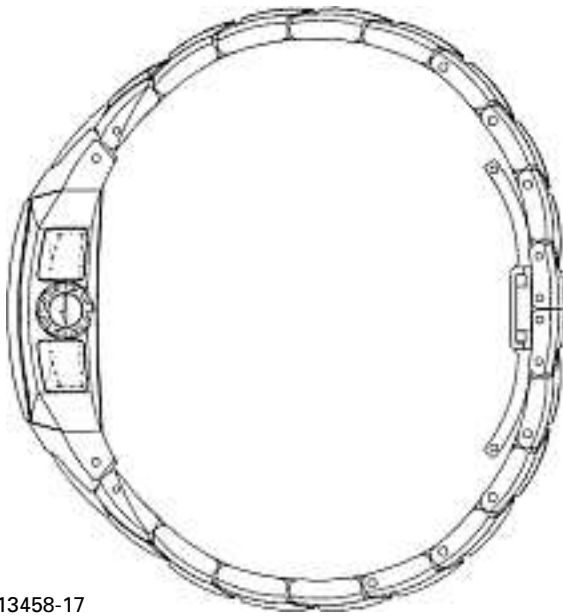

M13458-17

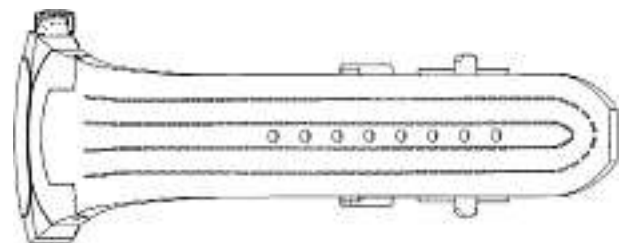
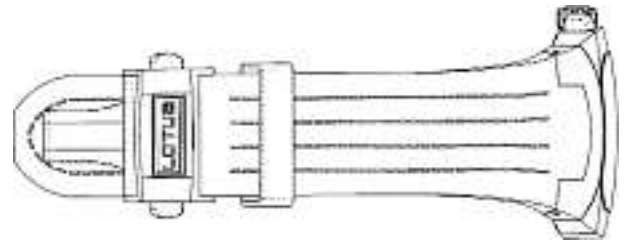



M13458-18

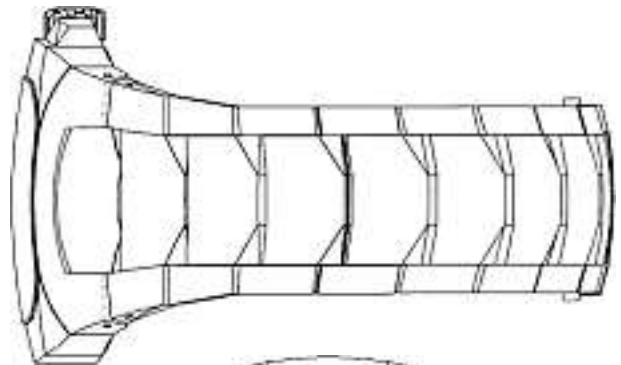
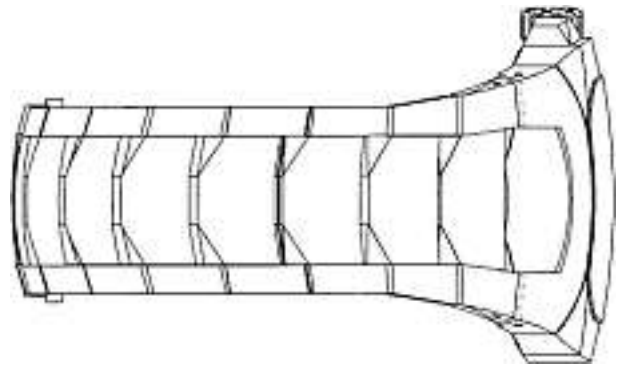
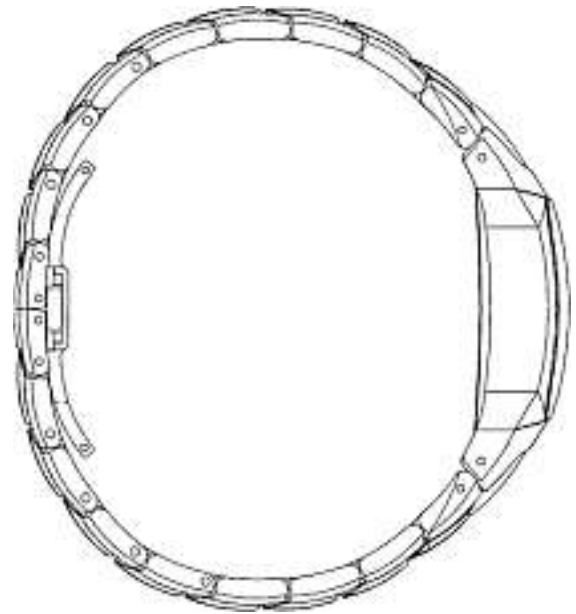

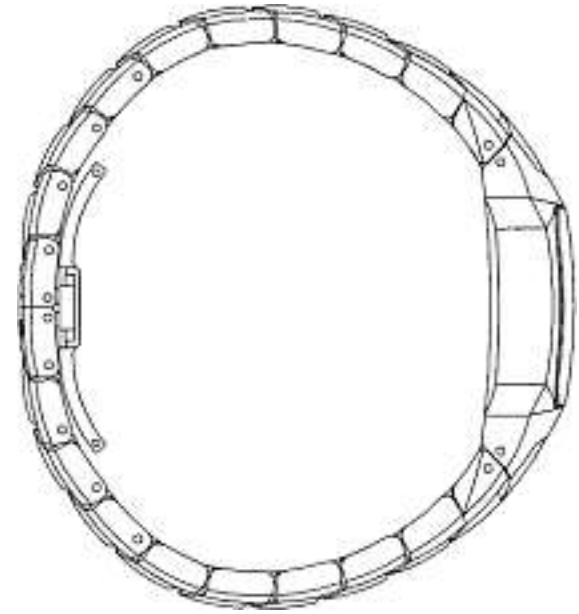
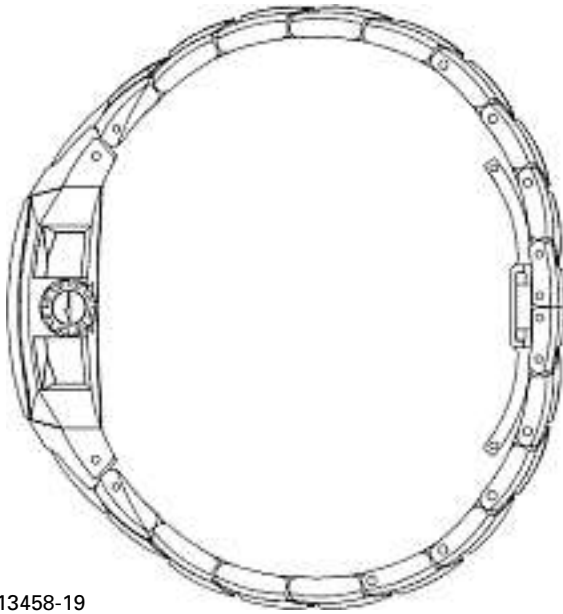

M13458-19

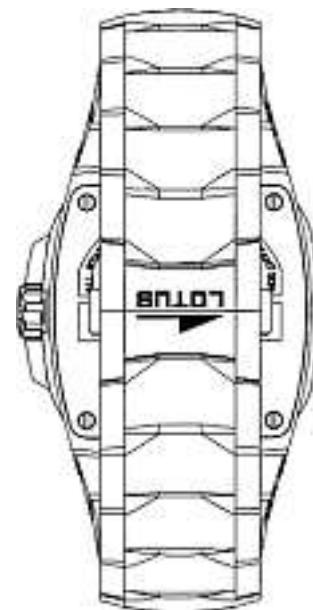
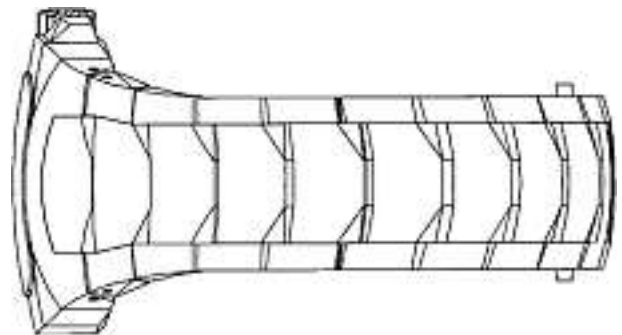
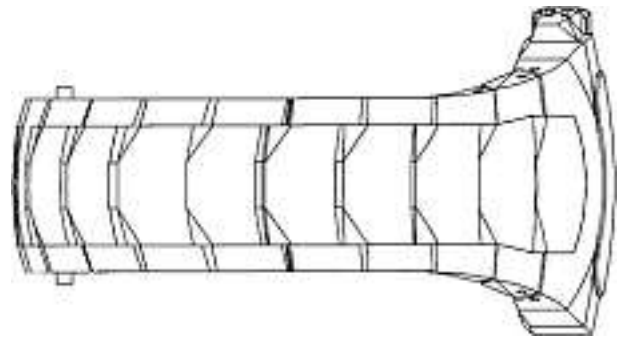



M13458-20

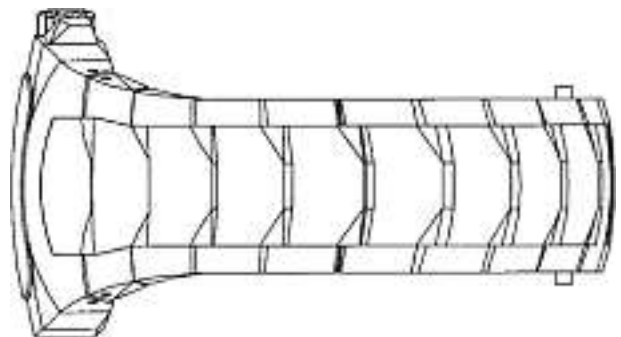
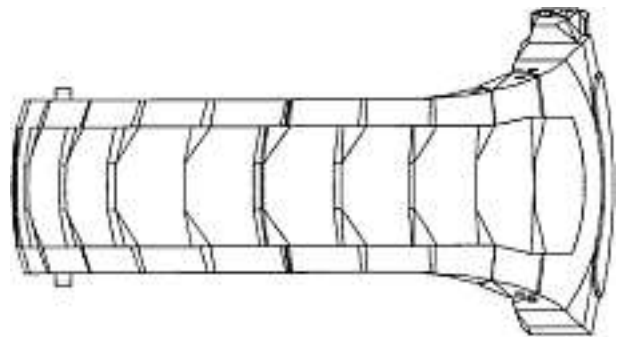
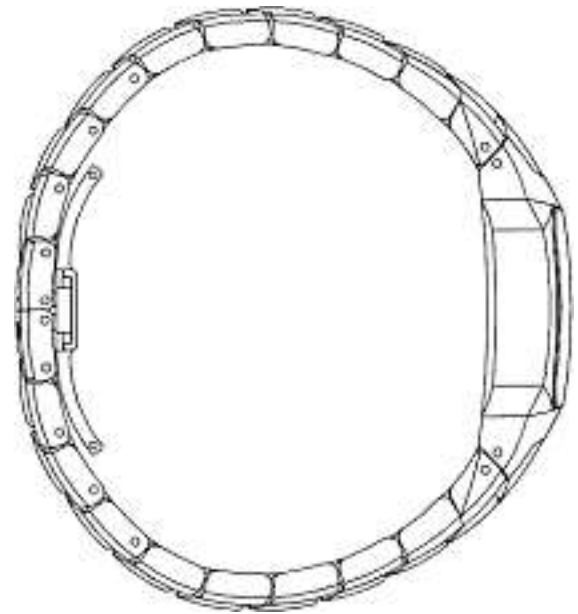

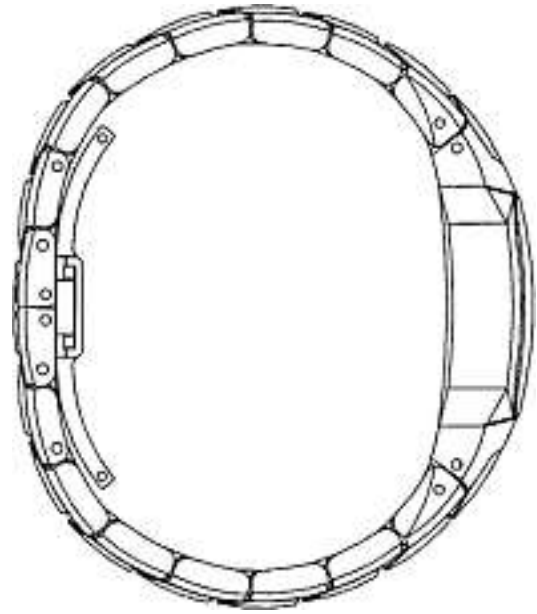
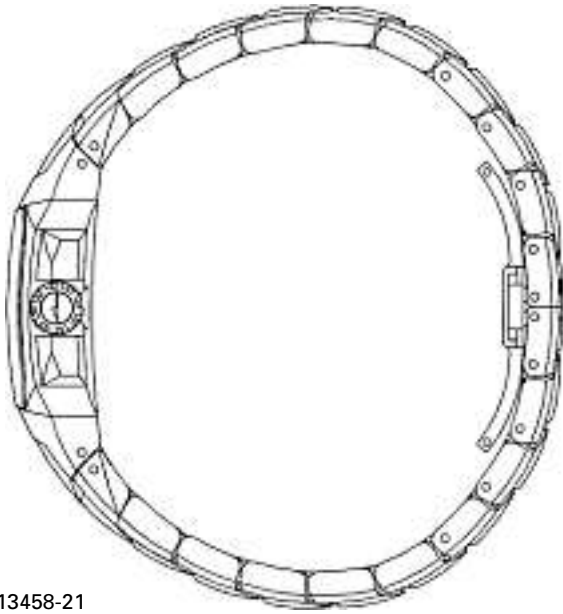

M13458-21

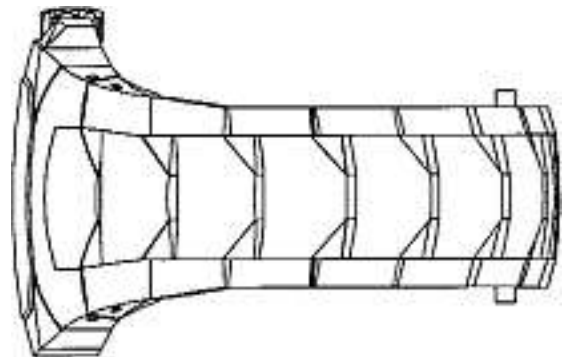
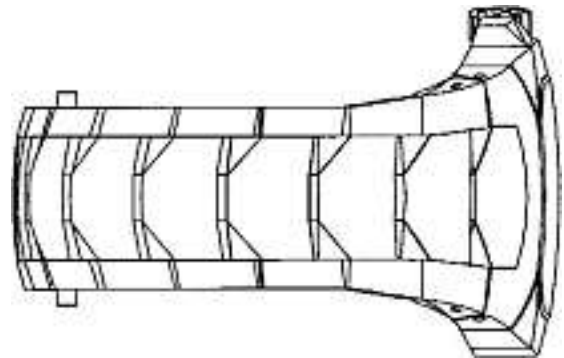

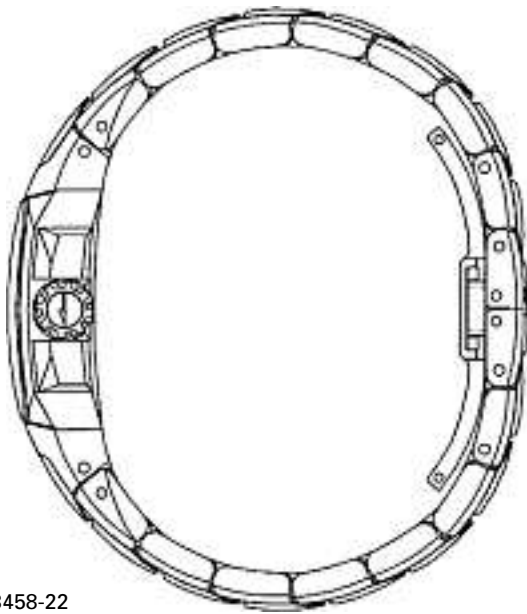

M13458-22

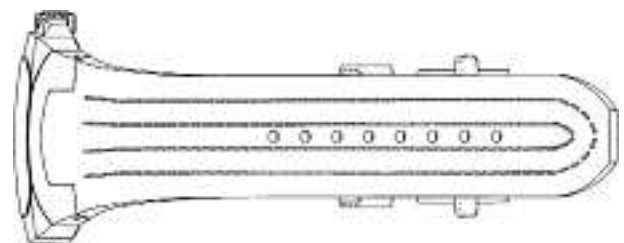
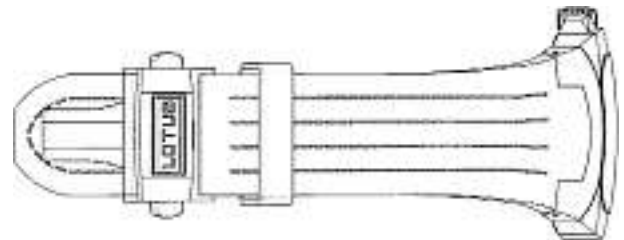
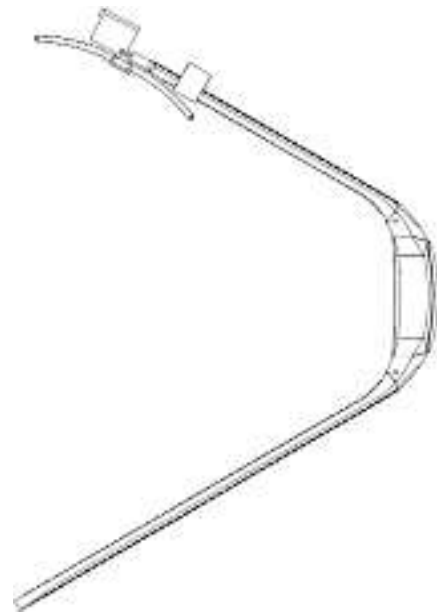

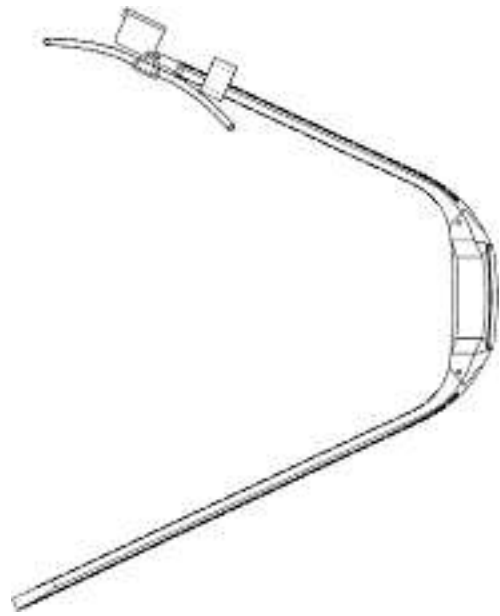
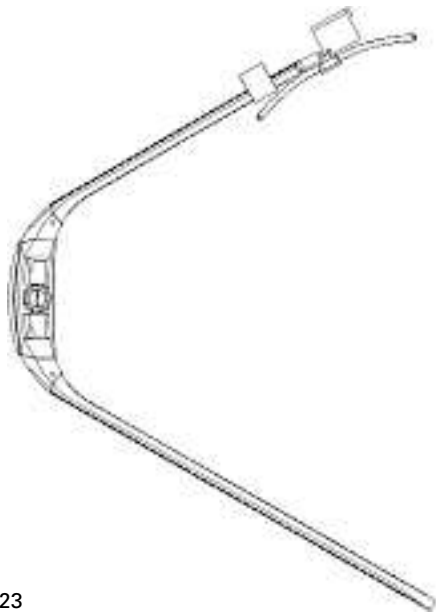

M13458-23

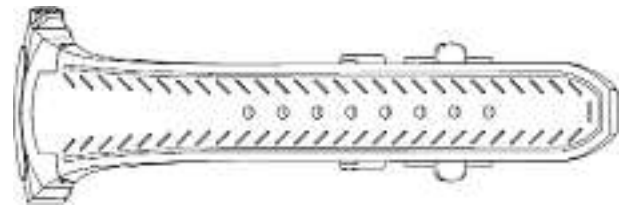
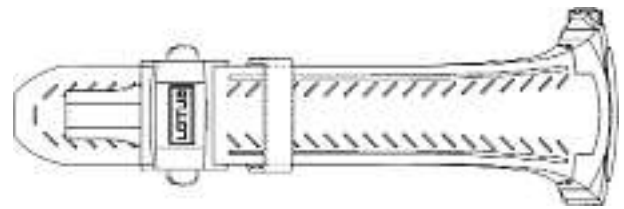

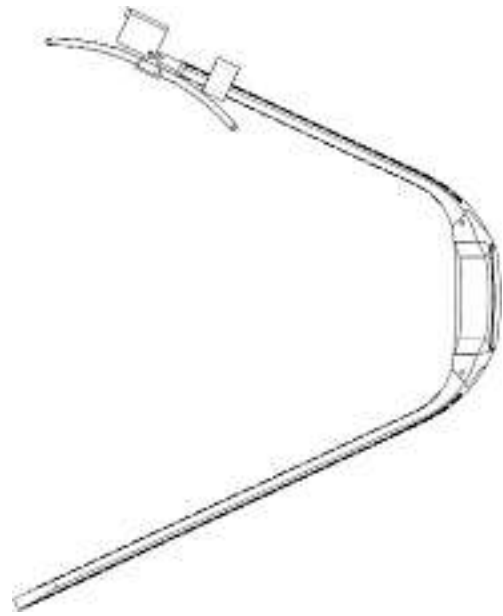
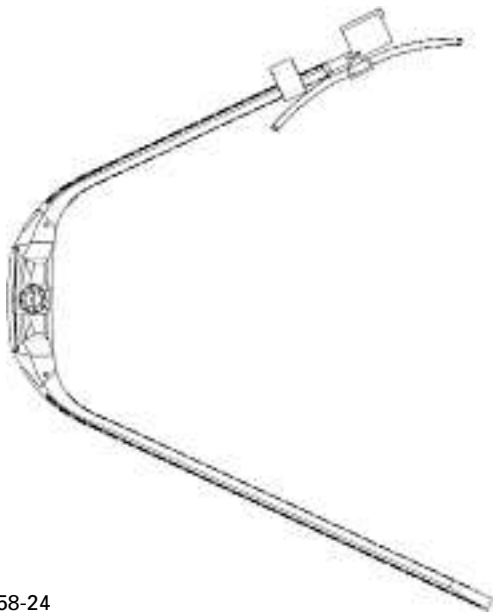

M13458-24

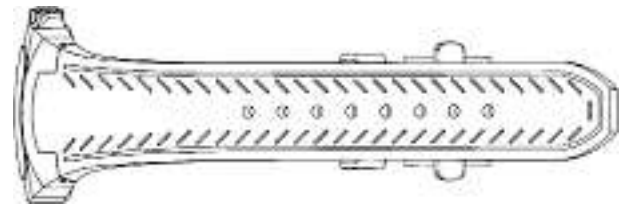
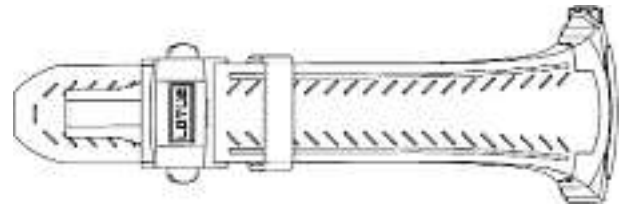

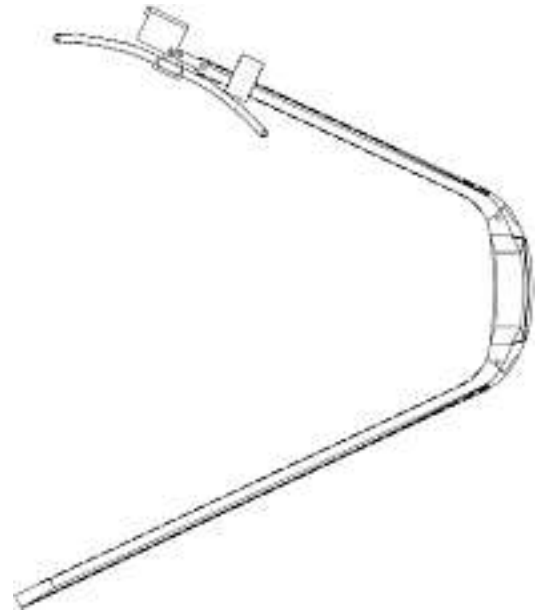
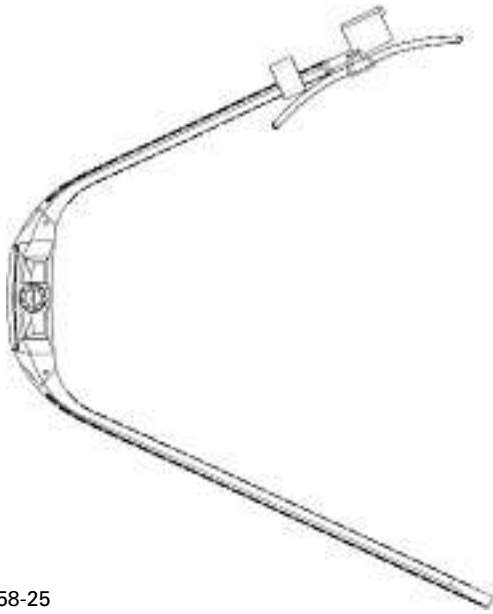

M13458-25

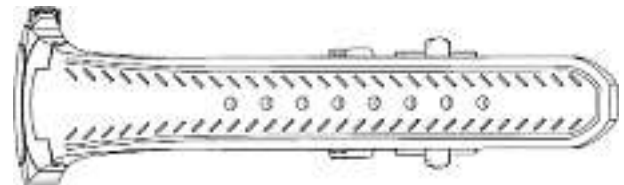
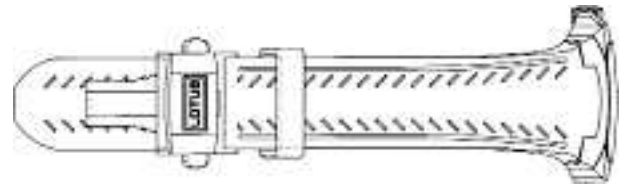

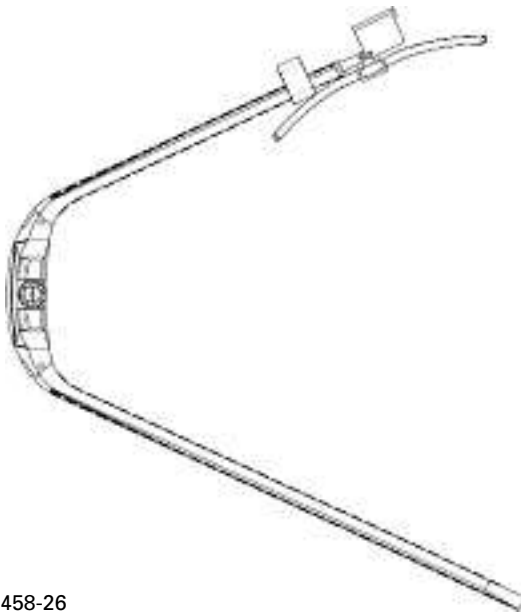

M13458-26

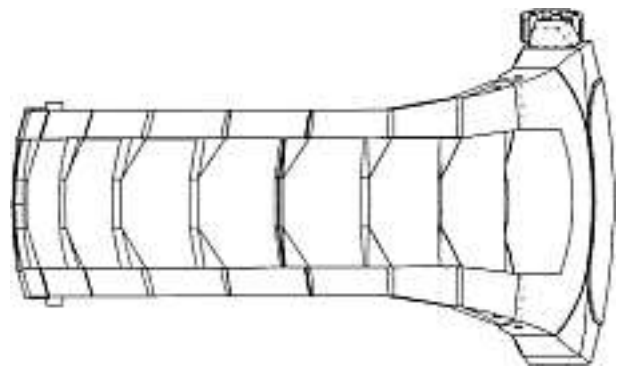
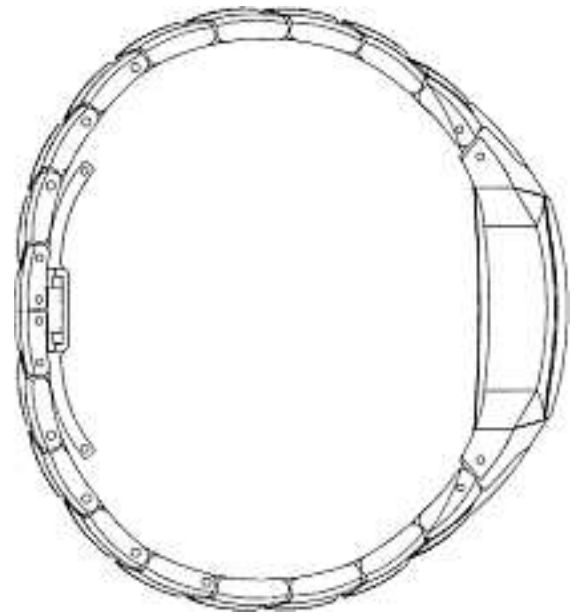

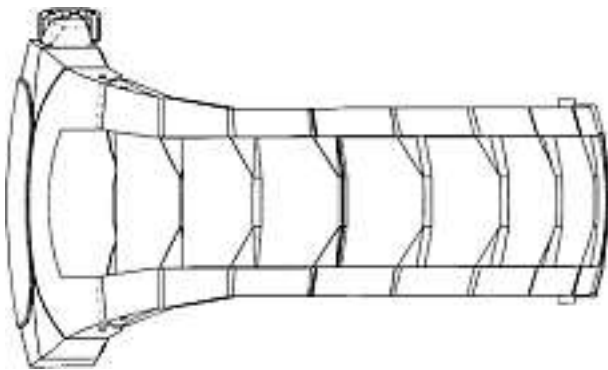

M13458-27

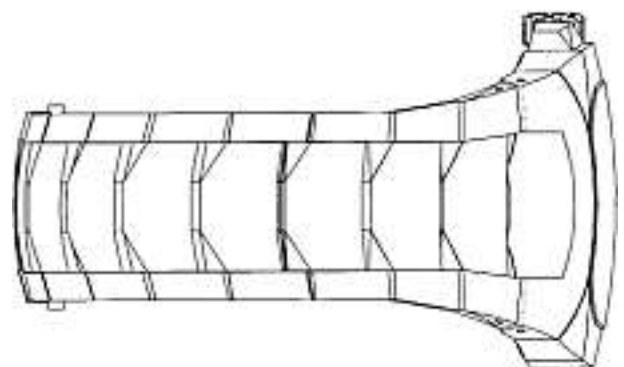
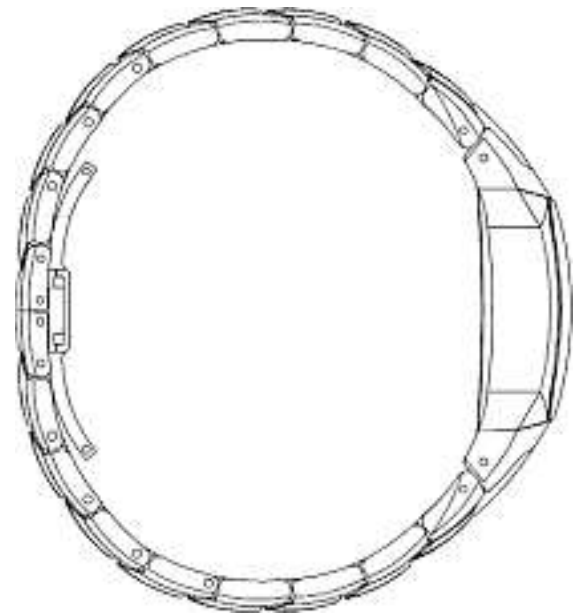

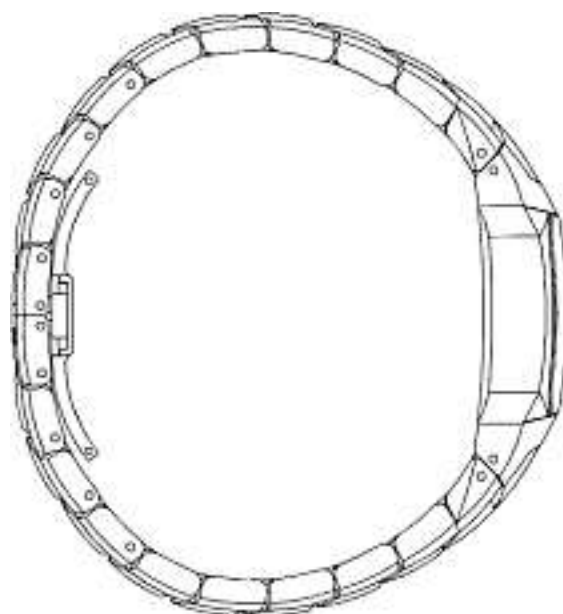
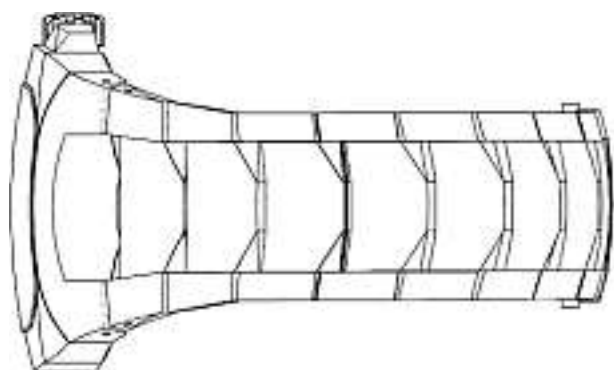

M13458-28

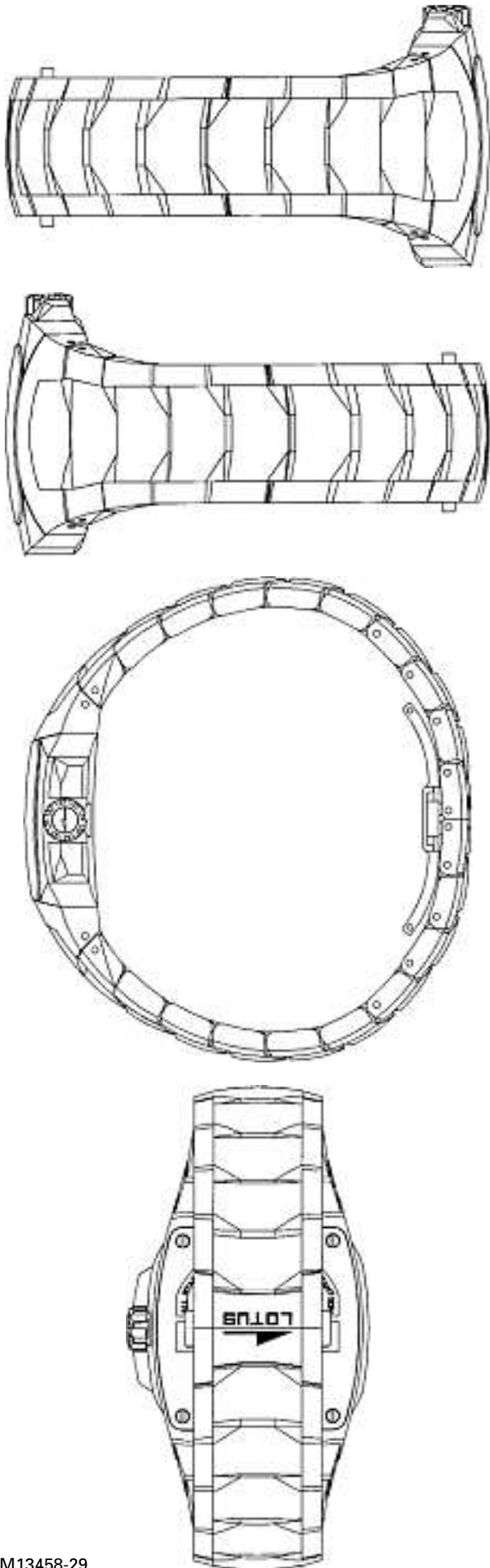

Cl. 11-01 134 728 21.12.2007
3 design – bagues
Déposant: Vernon White, 237 Florida Road, Morningside,
Durban 4001, ZA
Mandataire: Bugnion S.A., 1211 Genève 12 - Champel
Priorité: ZA, 02.07.2007



1



2



3

Cl. 12-11 **134 729** 21.01.2008
 1 Design – Fahrrad-Zubehör
 Hinterleger: Matsushita Electric Industrial Co., Ltd., 1006,
 Oaza Kadoma, Kadoma-shi, Osaka 571-8501, JP
 Designer: Shuhei Miyamoto, Osaka
 Vertreter: Bovard AG, 3000 Bern 25
 Priorität: JP, 11.12.2007

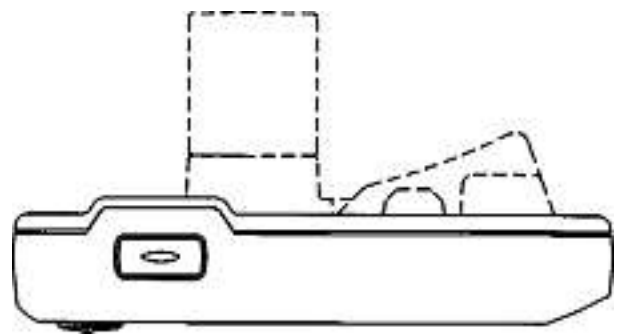
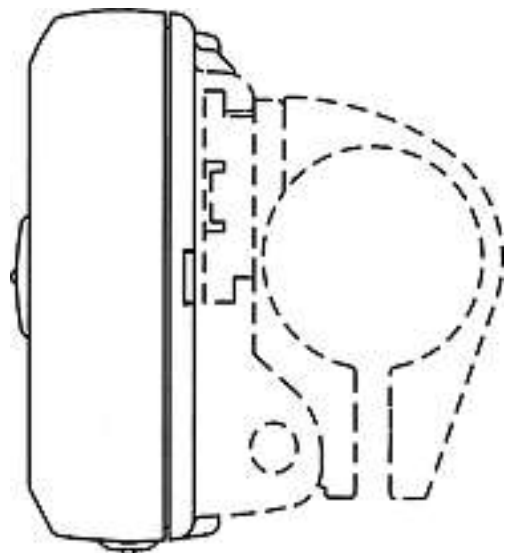
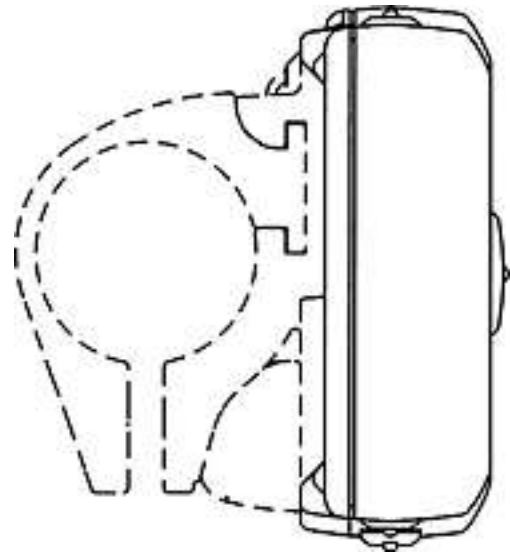
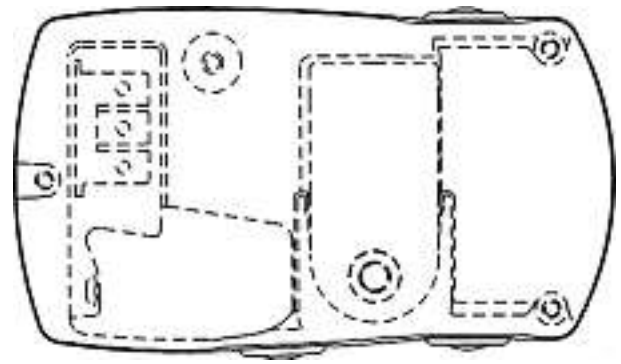
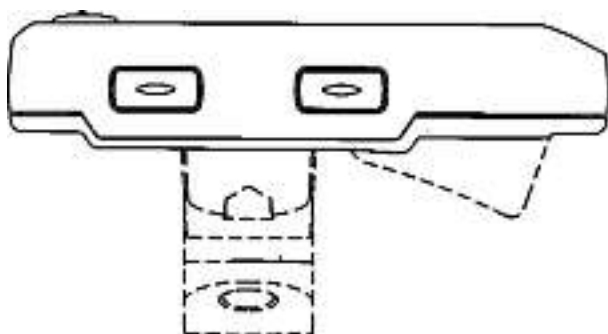
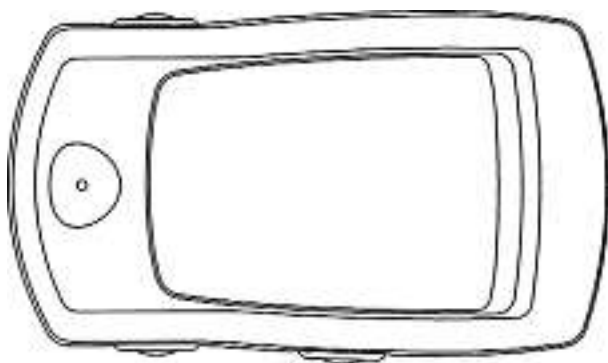

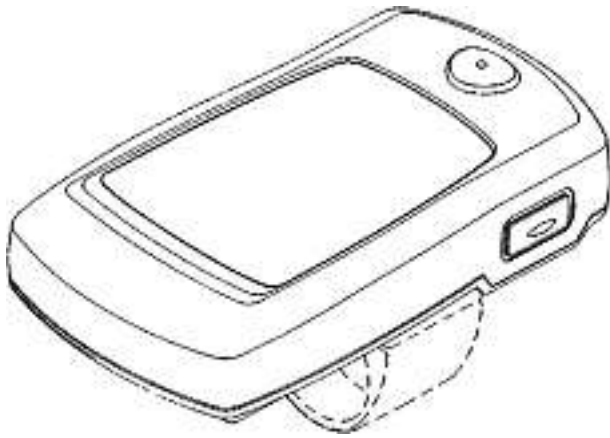

300640

Cl. 13-03 **134 730** 25.01.2008
 8 design – capteurs électriques
 Déposant: Liaisons Electroniques-Mécaniques LEM SA,
 Chemin des Aulx 8, 1228 Plan-les-Ouates
 Designer: Benjamin Marcoz, Collonges-sous-Saleves
 Mandataire: reuteler & cie S.A., 1260 Nyon

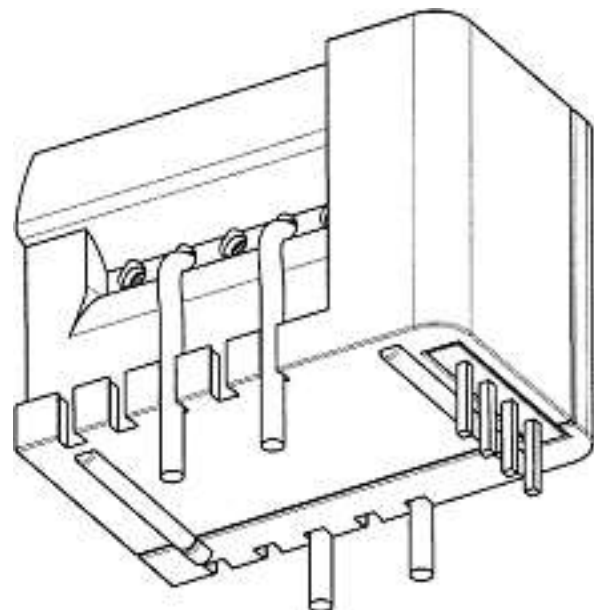
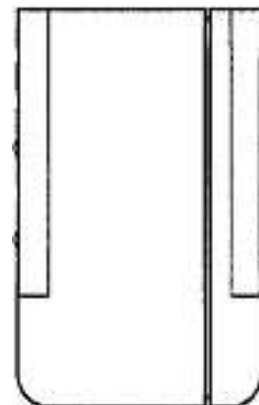
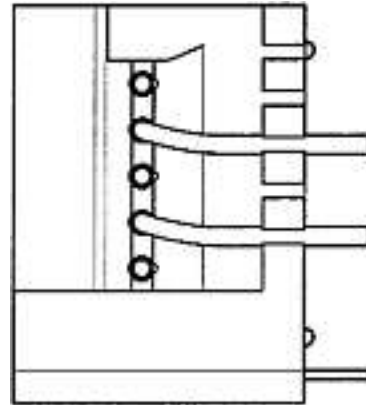
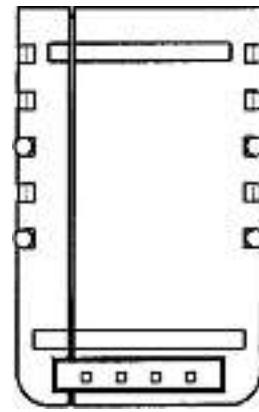
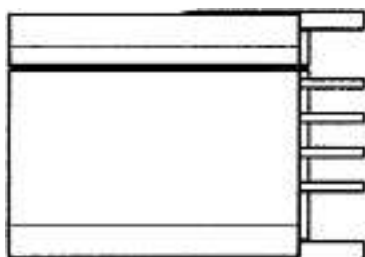
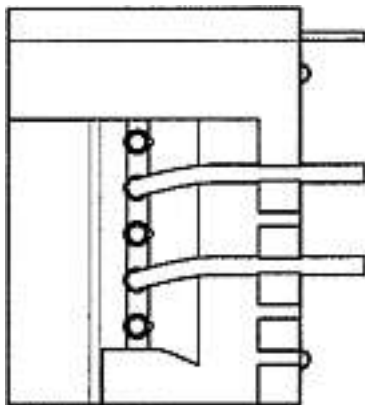

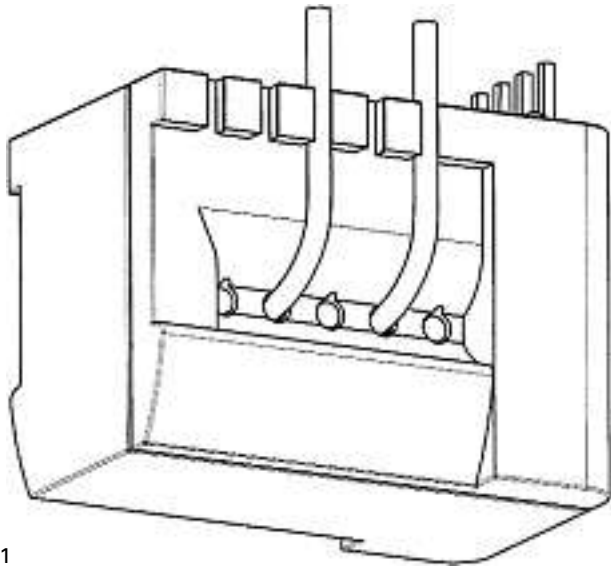
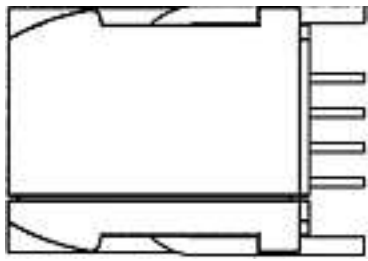

1

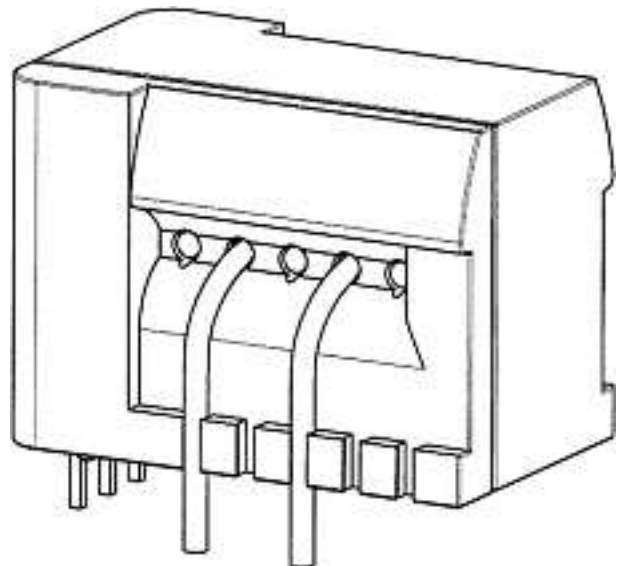
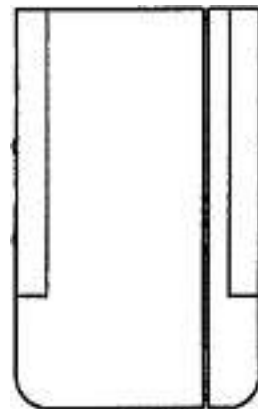
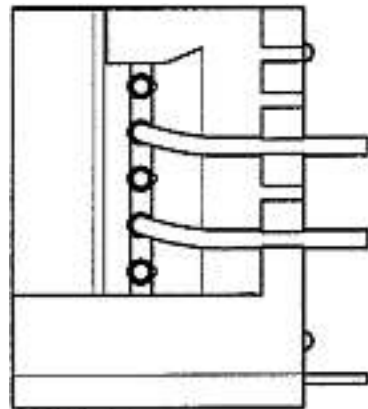
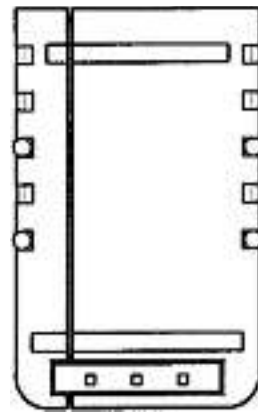
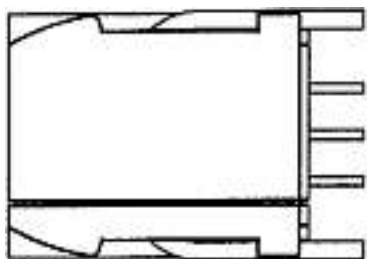
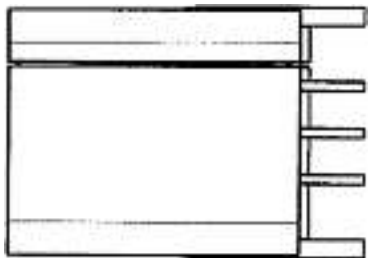
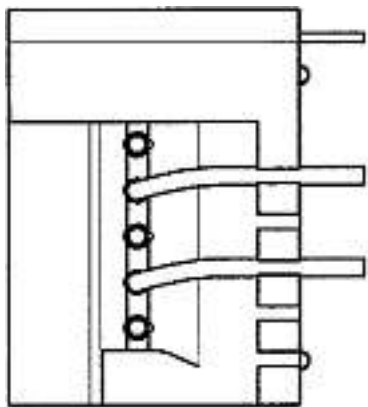

2

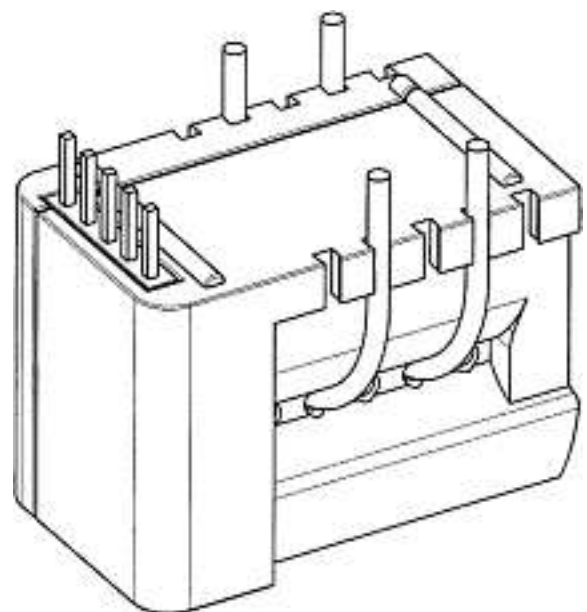
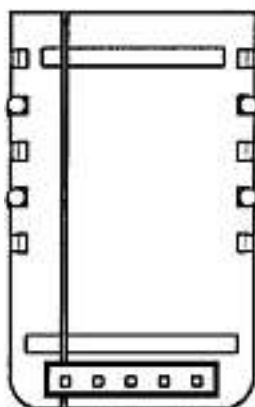
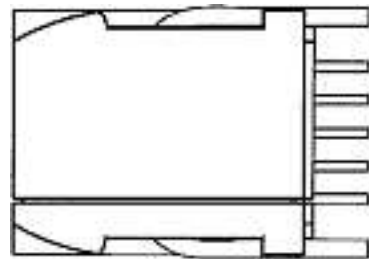
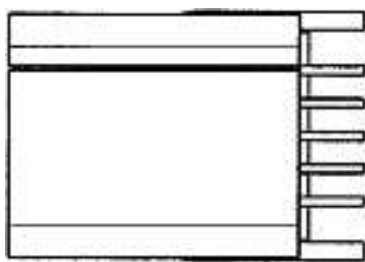
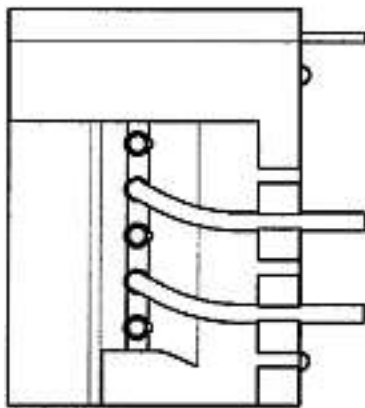
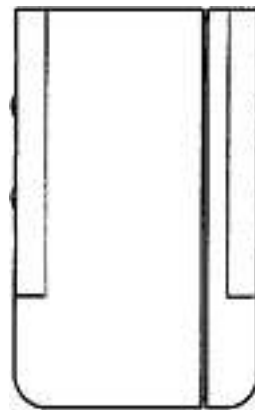
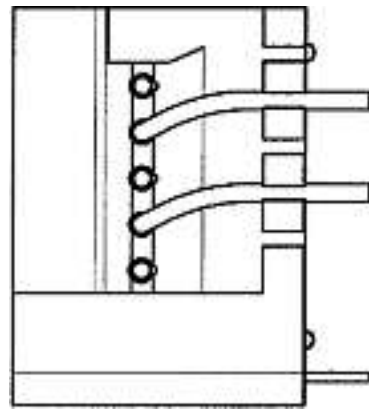
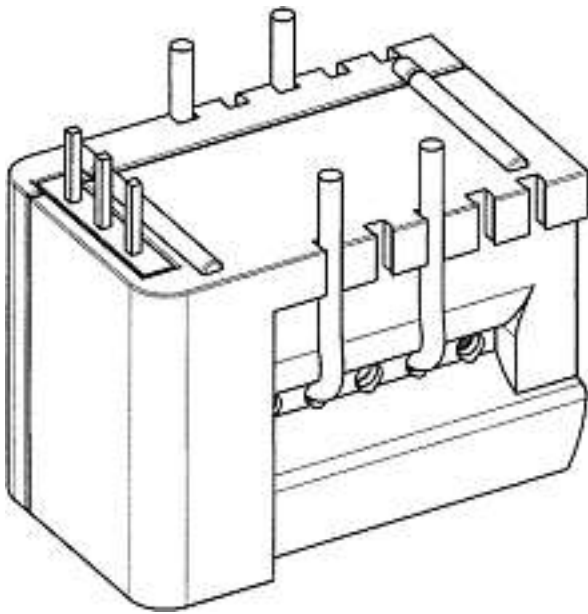

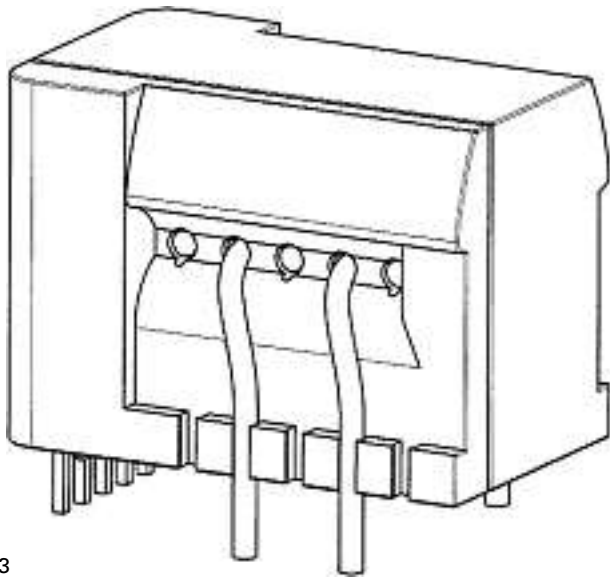

3

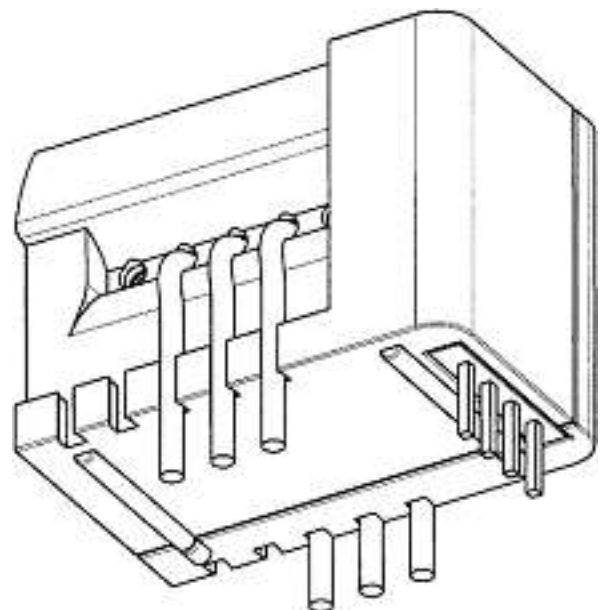
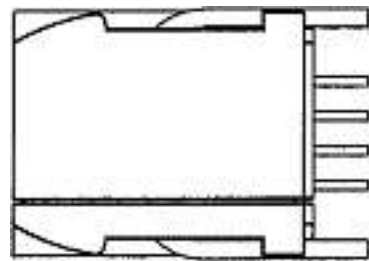
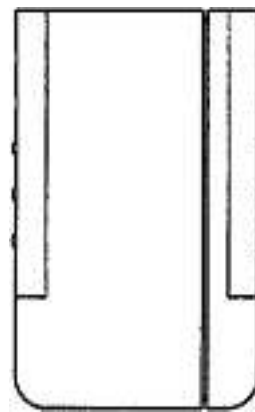
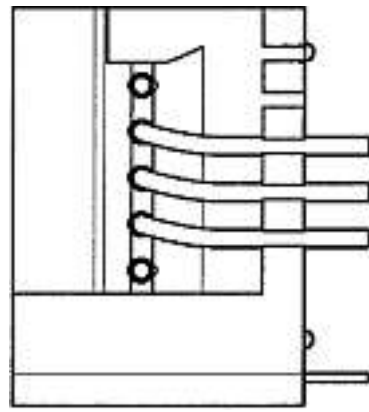
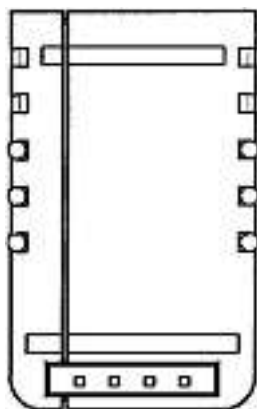
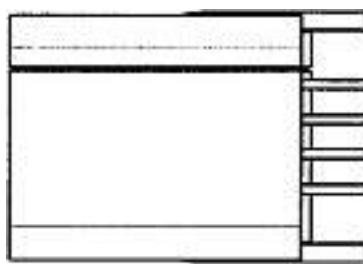
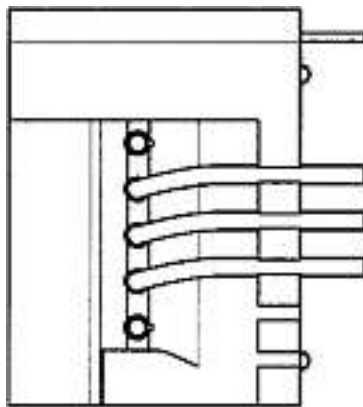

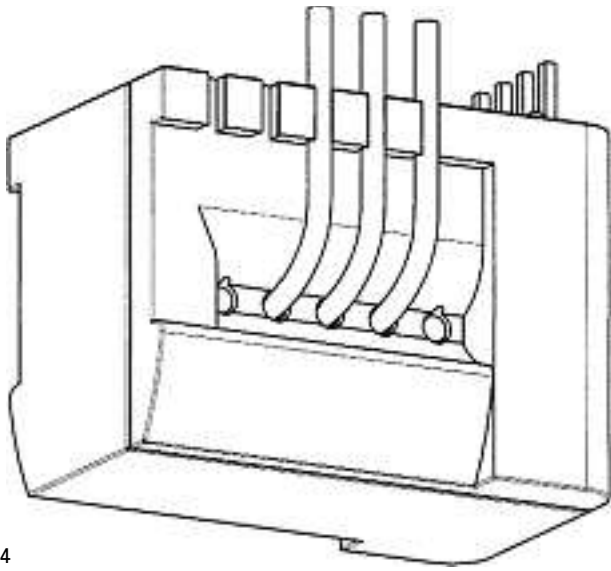

4

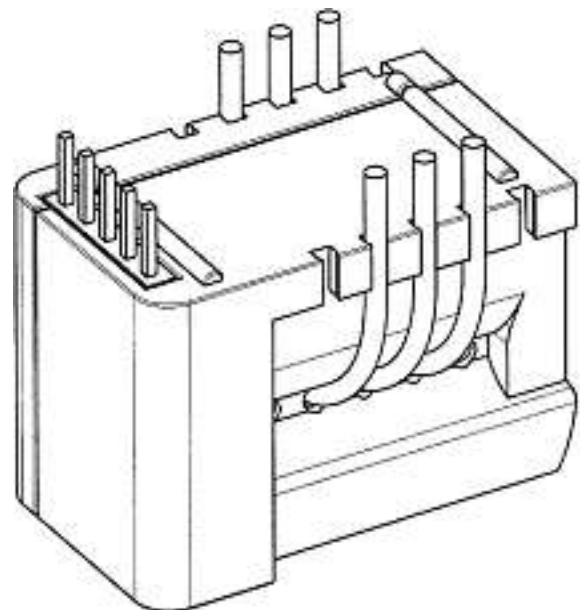
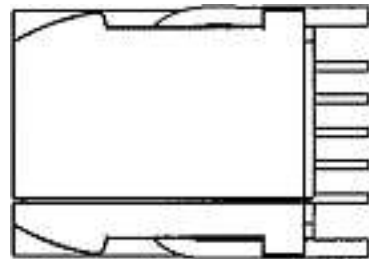
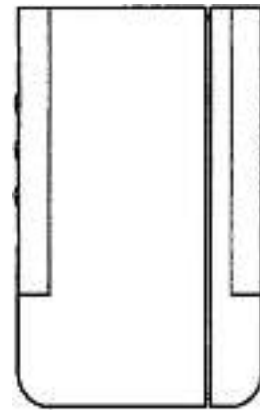
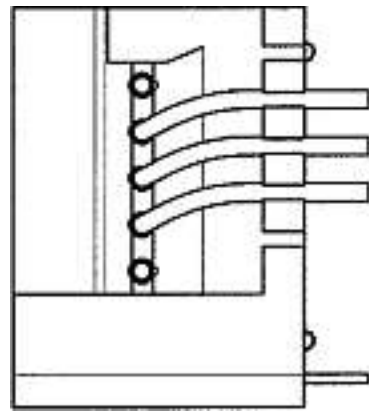
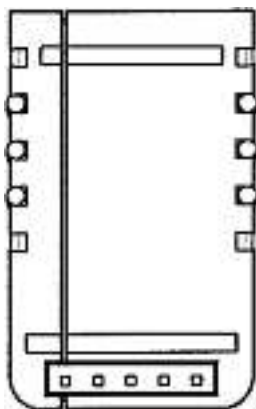
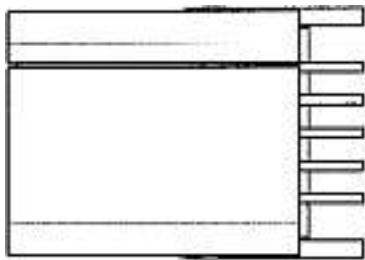
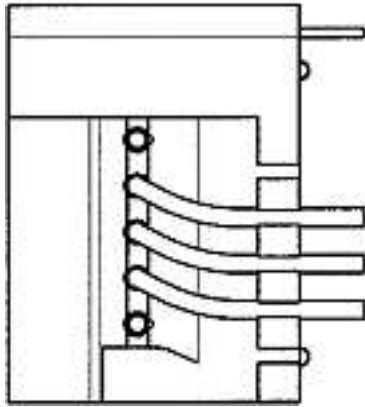

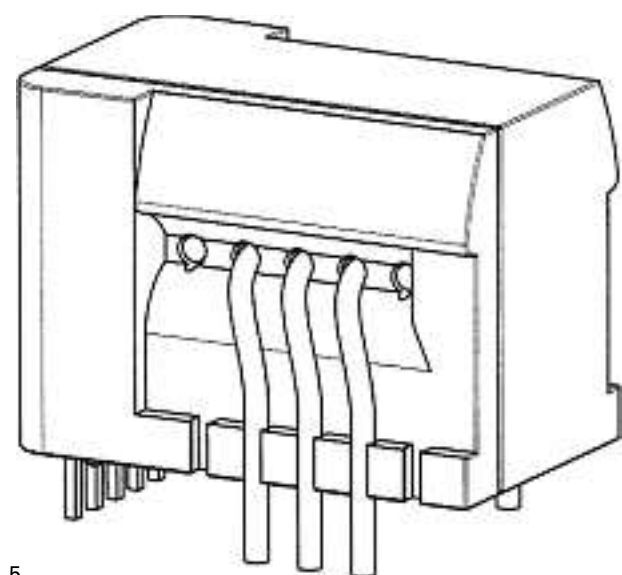

5

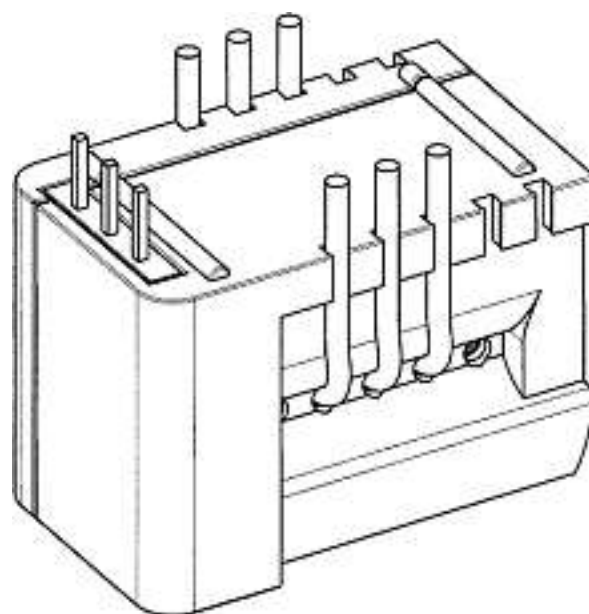
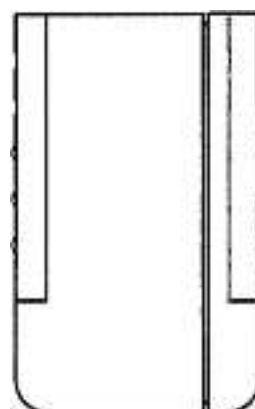
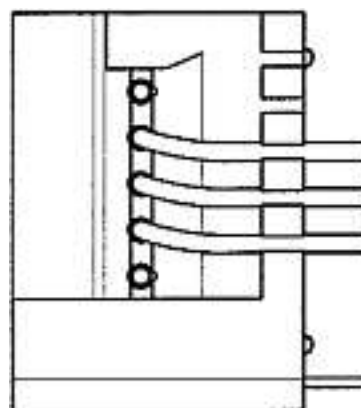
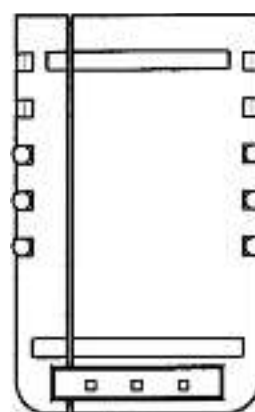
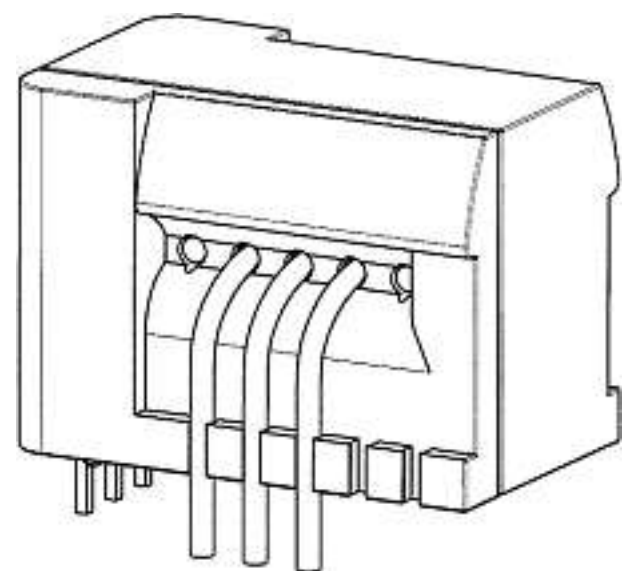
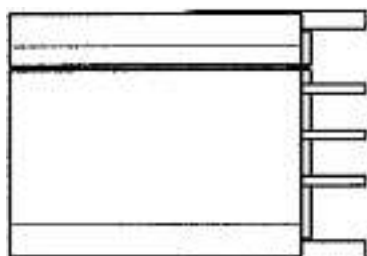
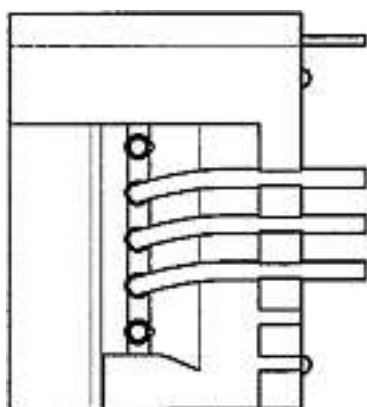

6

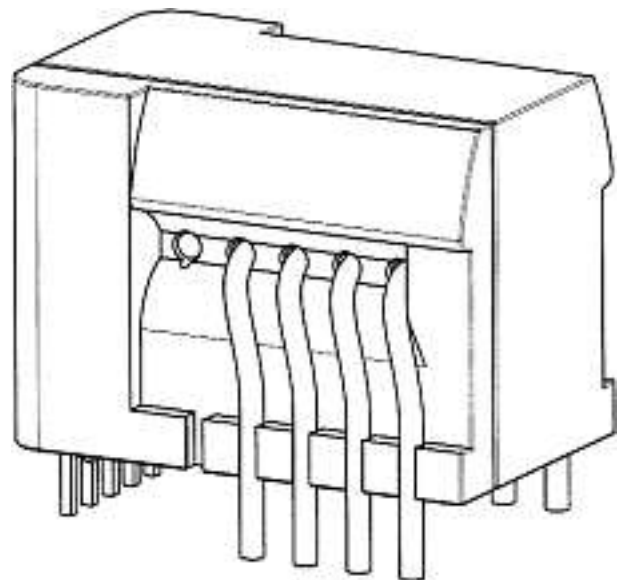
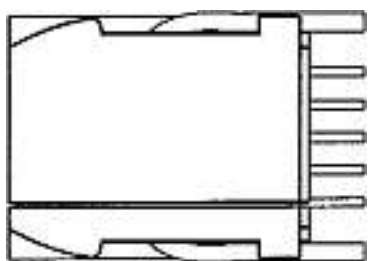
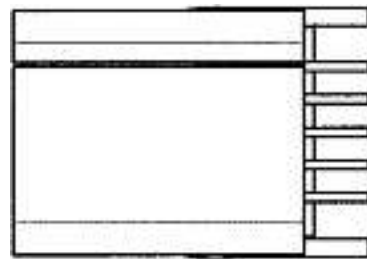
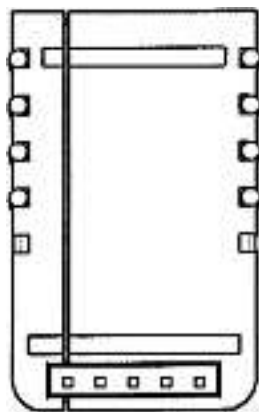
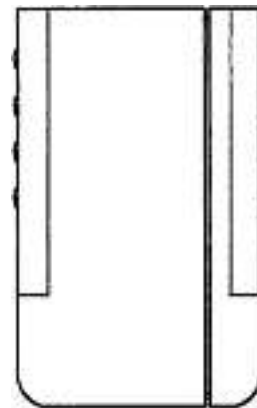
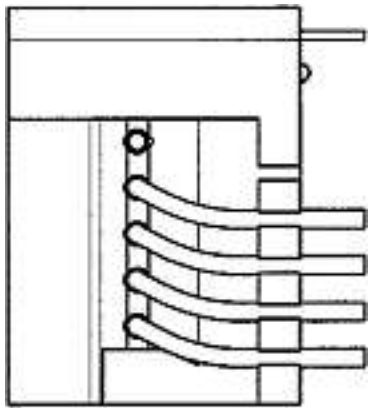
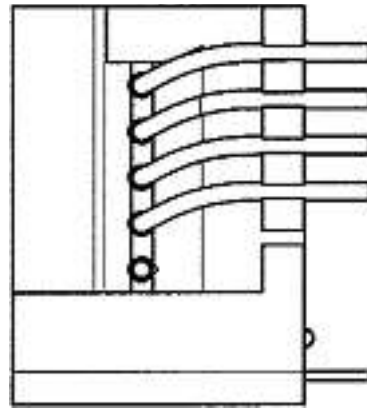
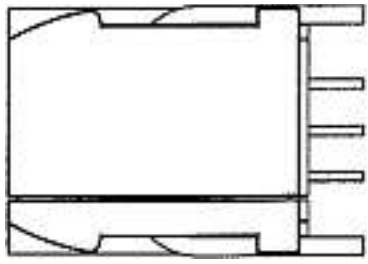

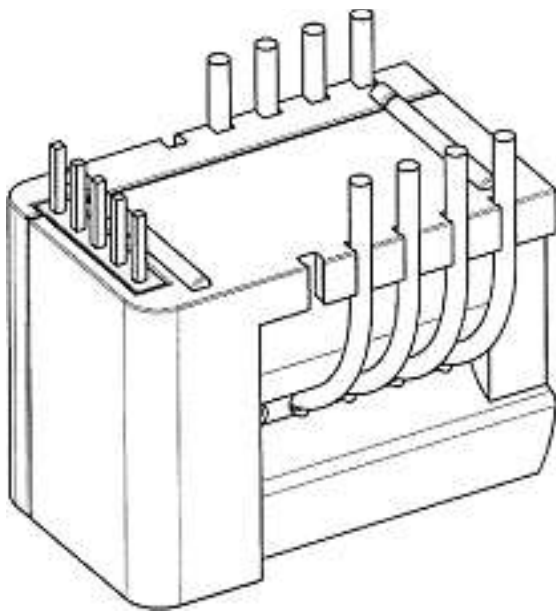

7

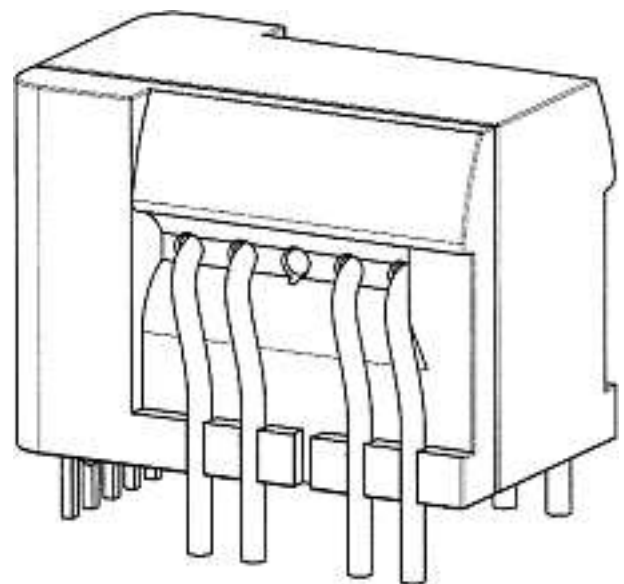
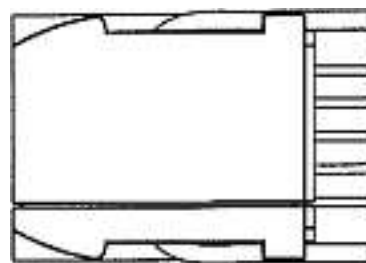
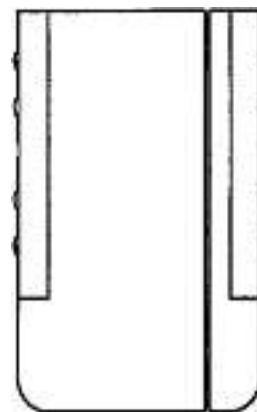
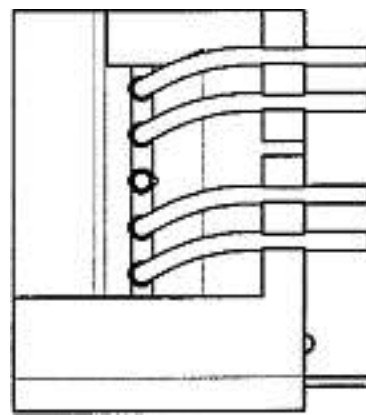
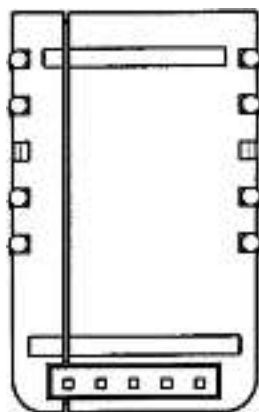
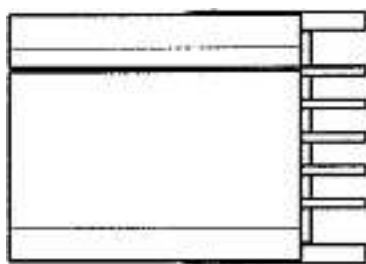
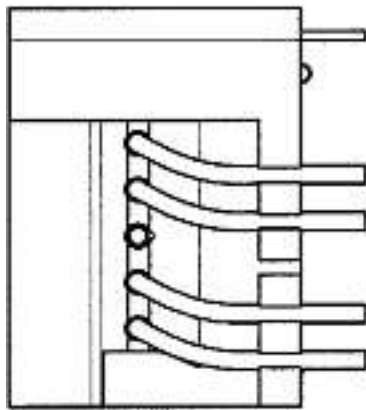

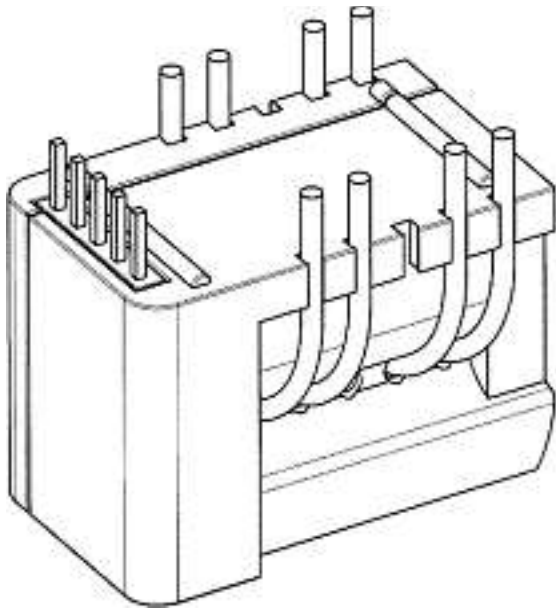

8

Cl. 14-02 **134 731** 29.01.2008
 2 Design – Tonerkassette, Trommleinheit
 Hinterleger: Brother Industries, Ltd, 15-1, Naeshiro-cho,
 Mizuho-ku, Nagoya-shi / Aichi-ken, JP
 Designer: Satoru Ishikawa, Nagoya; Hirofumi Sato, Nagoya;
 Fumio Morita, Nagoya; Satoru Hattori, Nagoya; Tatsuo
 Ogasawara, Nagoya; Yasuo Fukamachi, Nagoya
 Vertreter: E. Blum & Co. AG, Patent- und Markenanwälte VSP,
 8044 Zürich
 Priorität: JP, 10.08.2007; JP, 10.08.2007

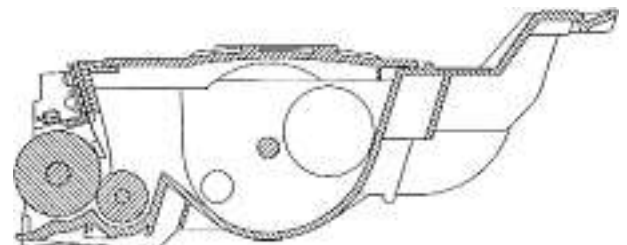
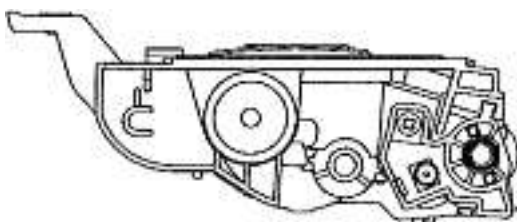
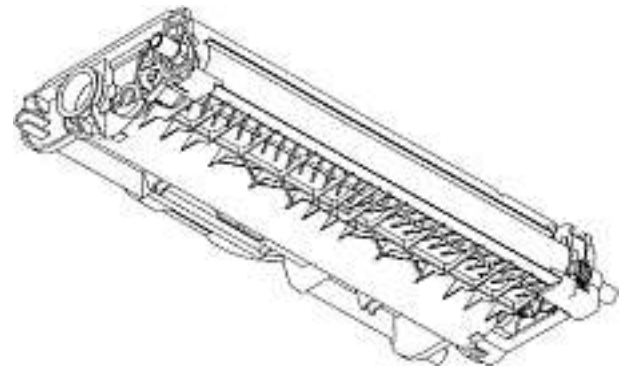
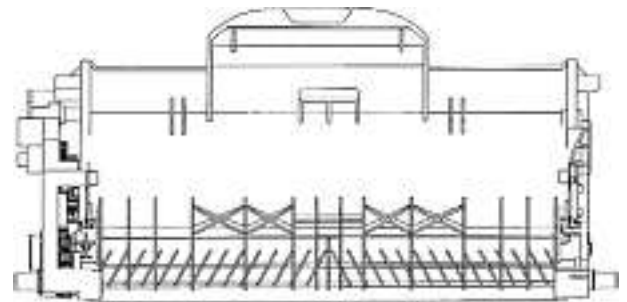
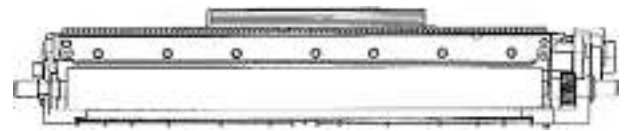

A-2007/1058a

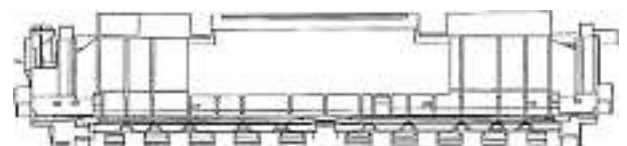
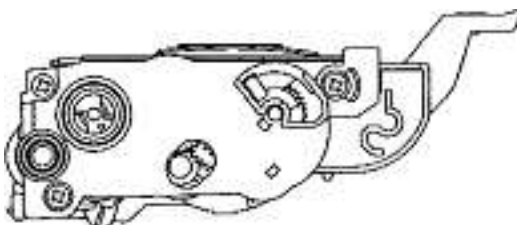

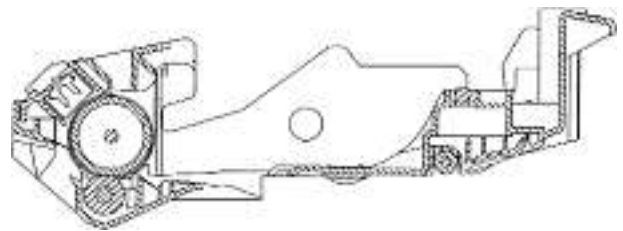
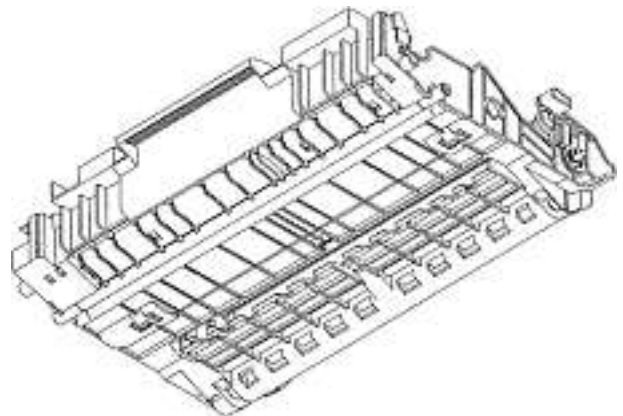
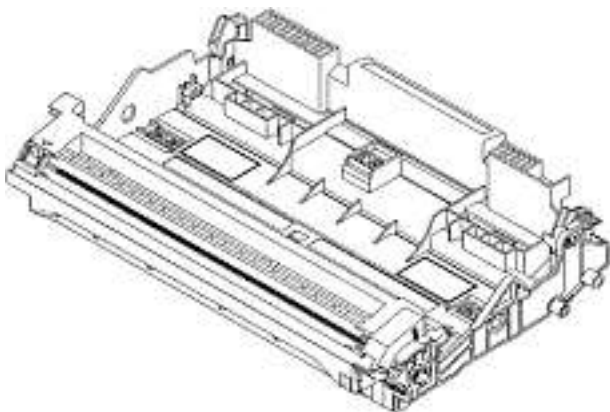
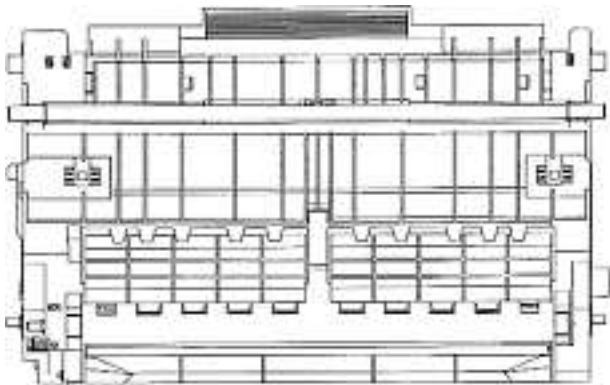
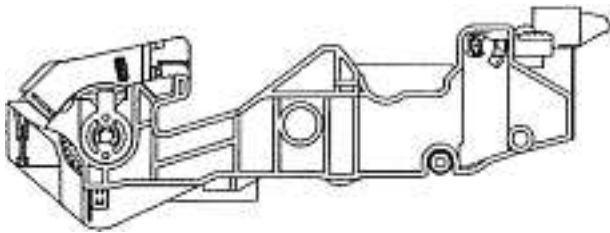
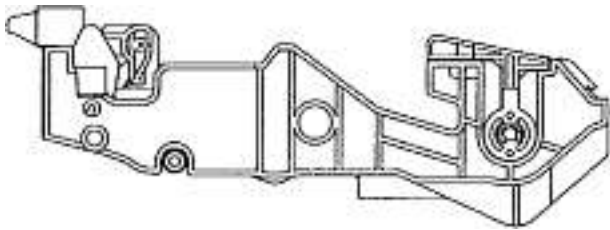
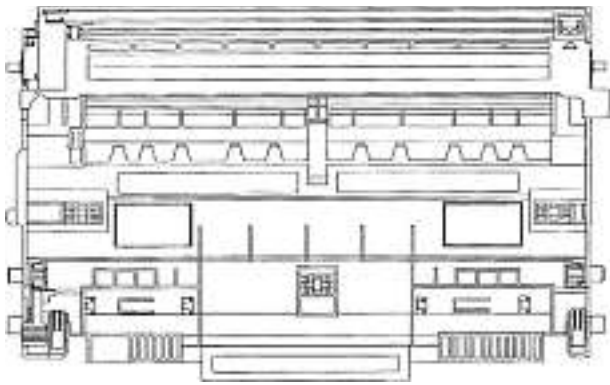

A-2007/1058b

Cl. 15-05 **134 732** 23.01.2008
 2 Design – Staubsauger
 Hinterleger: Aktiefbolaget Electrolux, St. Göransgatan 143,
 105 45 Stockholm, SE
 Designer: Christian Agren, Stockholm
 Vertreter: Troesch Scheidegger Werner AG, Patent- und
 Markenanwälte, 8126 Zumikon
 Priorität: EM, 27.11.2007

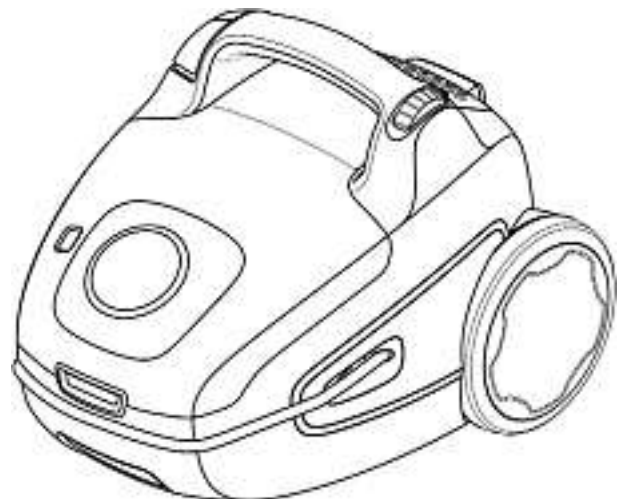

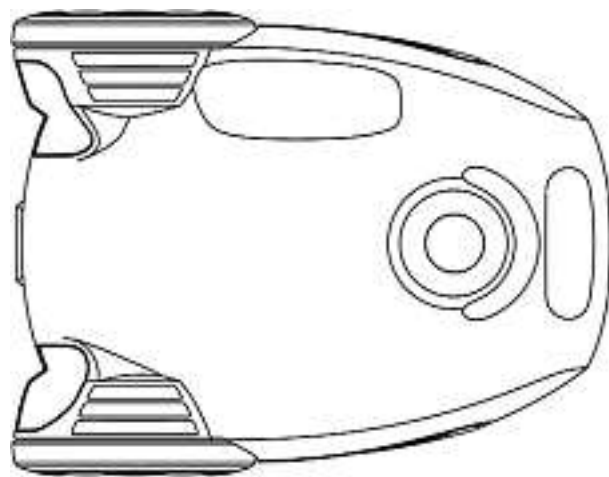
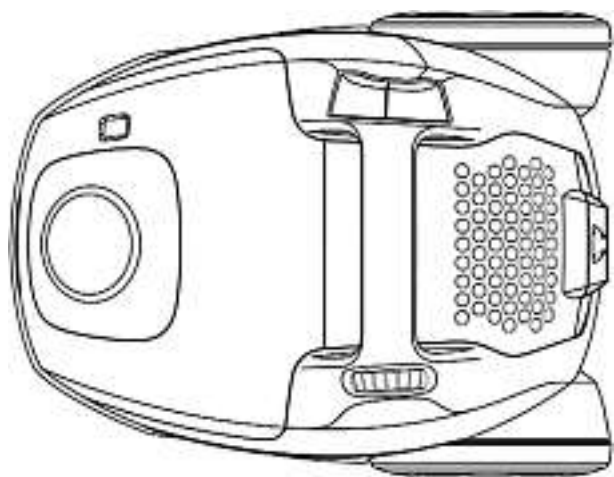
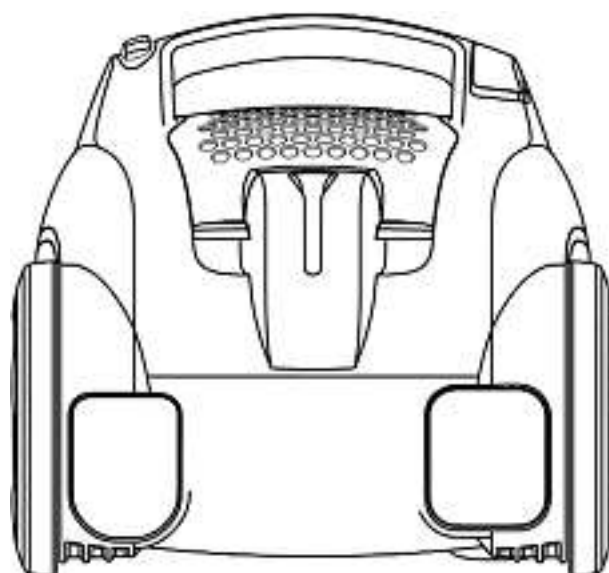
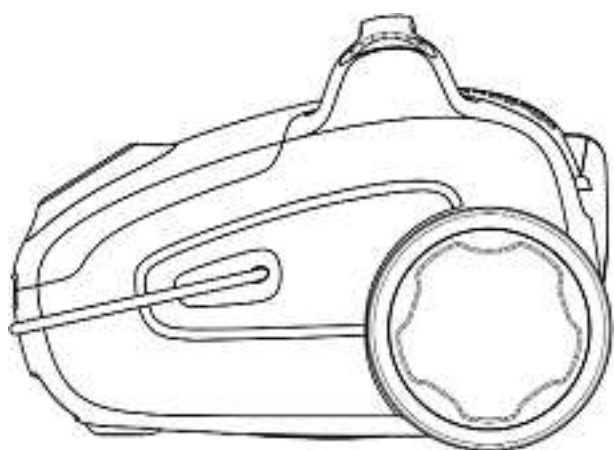
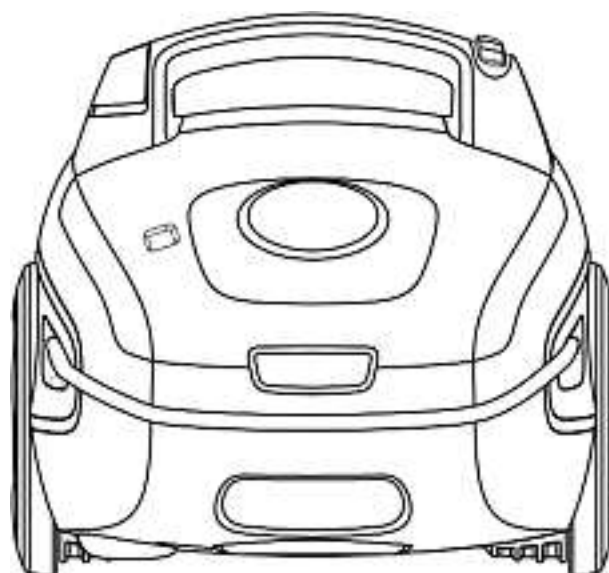
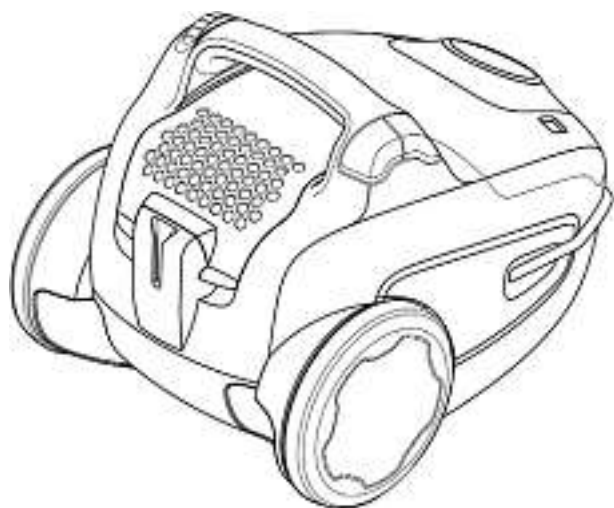

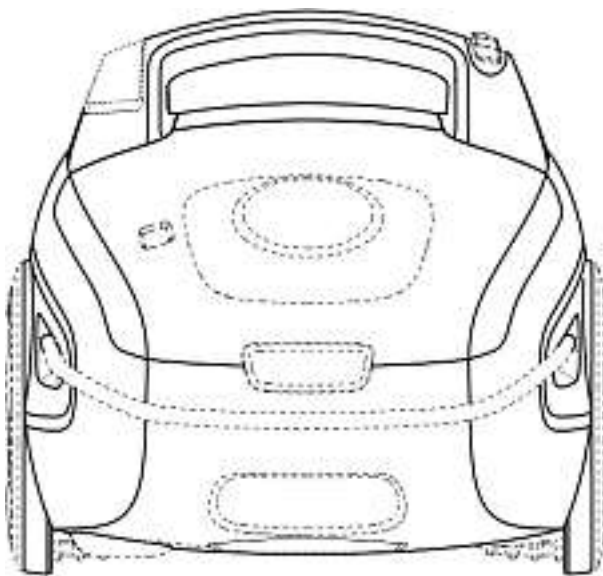
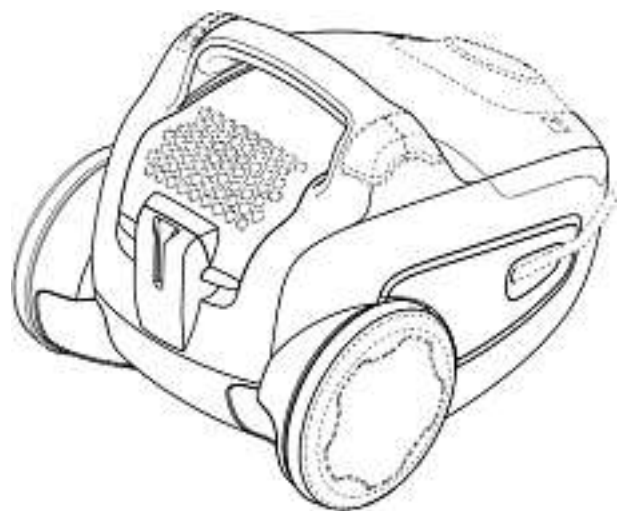
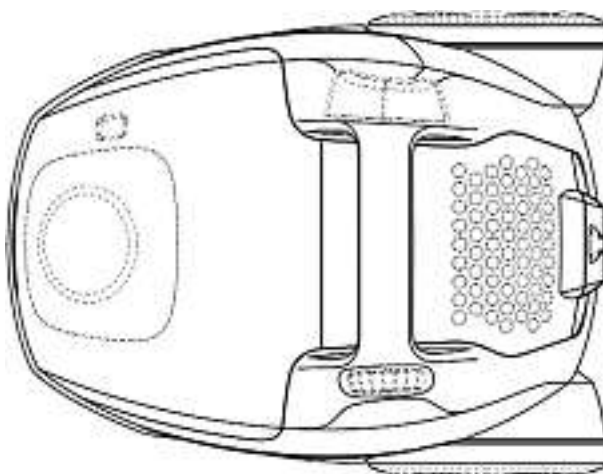
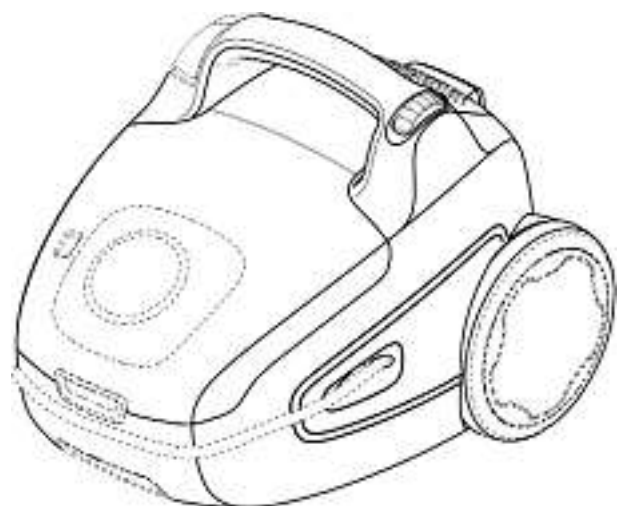
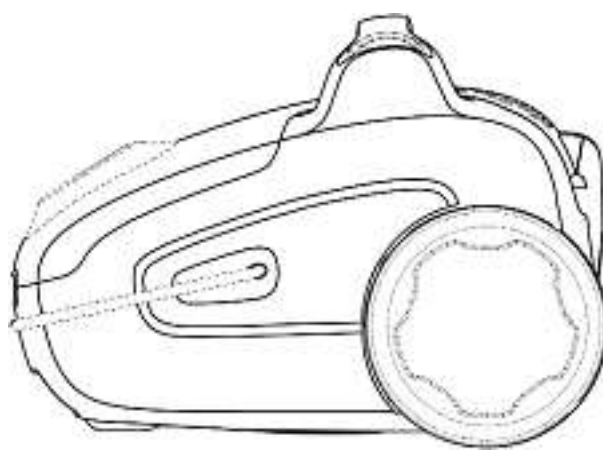
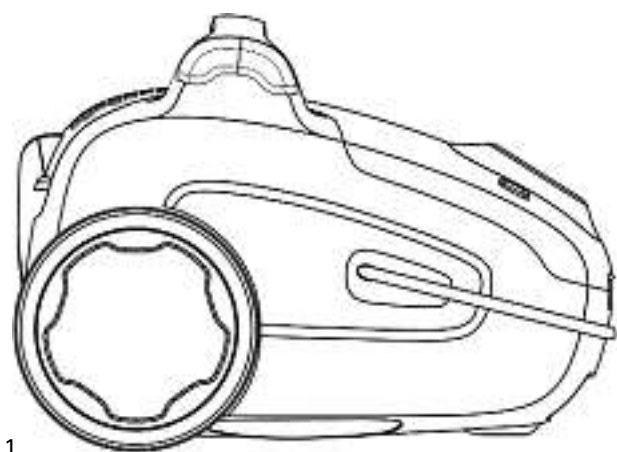

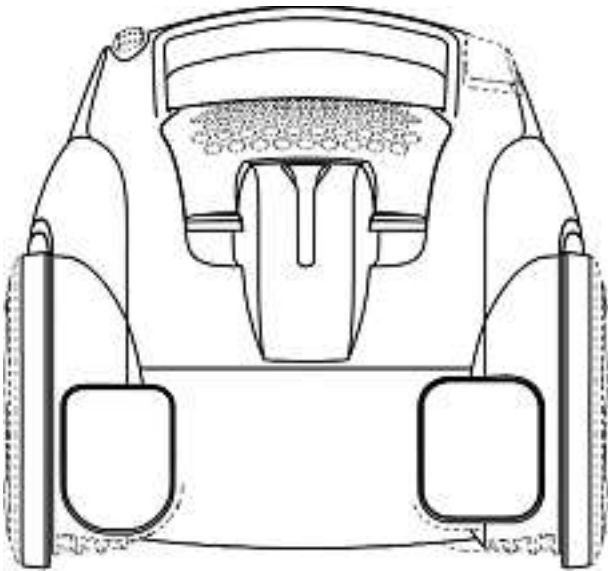

Kuh

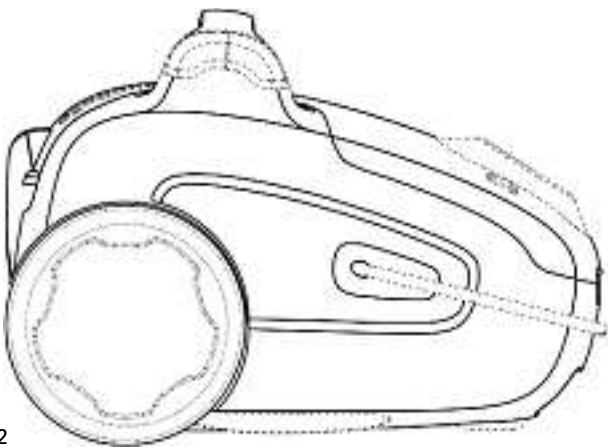
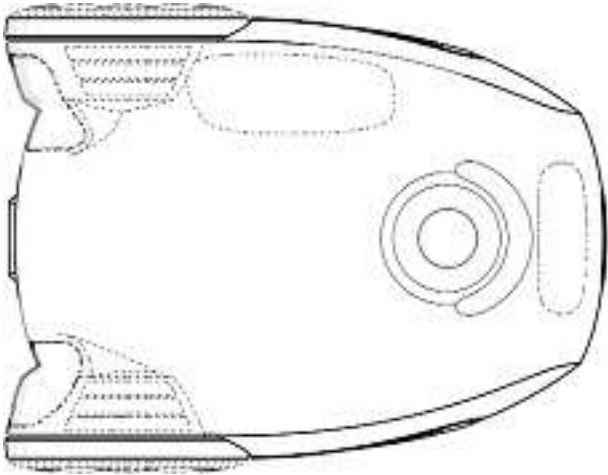

2

Cl. 21-01 **134 734** 12.01.2008
2 Design – Spiel-Bauklotz
Hinterleger: Werner Zemp, Rehweg 2, 8044 Gockhausen

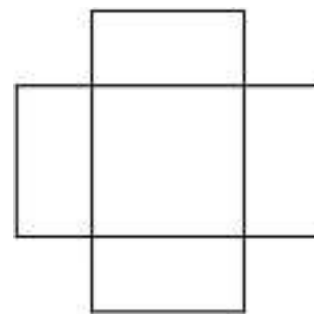
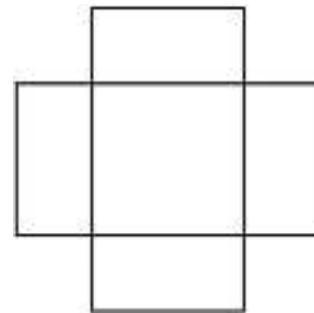
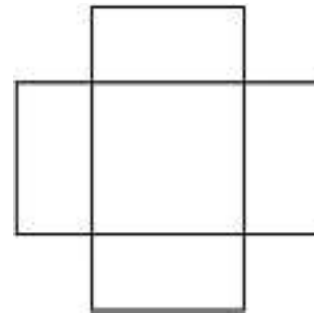

Cl. 19-08 **134 733** 21.01.2008
1 Design – Druckvorlage
Hinterleger: alba Albin Breitenmoser AG, Zielstrasse 38,
9050 Appenzell
Designer: Michael Steinlin, Teufen

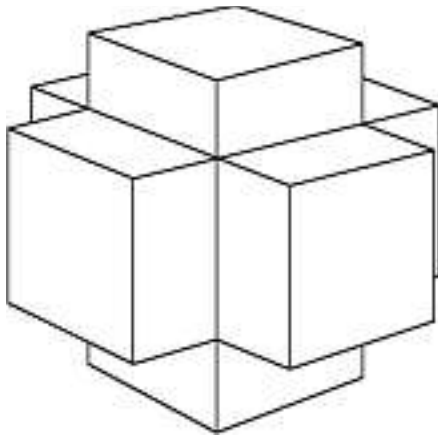

1

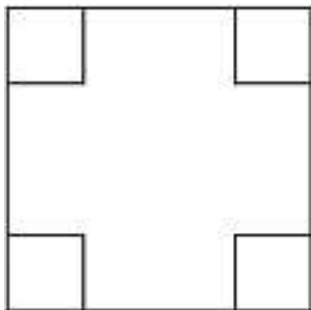
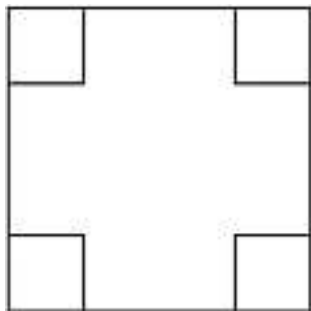
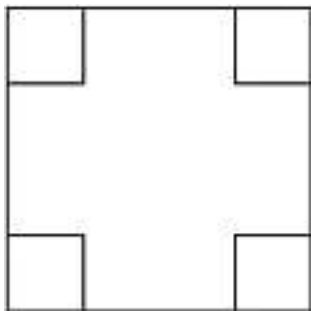

2

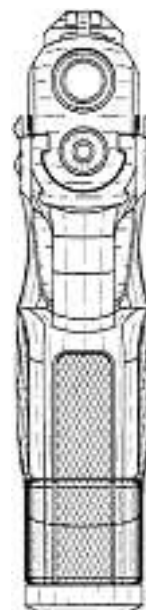

Cl. 22-01 134 735 22.01.2008
 6 design – pistolets
 Déposant: Sturm, Ruger & Company, Inc., One Lacey Place,
 Southport, CT 06890, US
 Designer: James McGarry, Prescott Valley
 Mandataire: Kirker & Cie S.A., Ingénieurs-Conseils,
 1226 Genève - Thônex
 Priorité: US, 25.07.2007

1

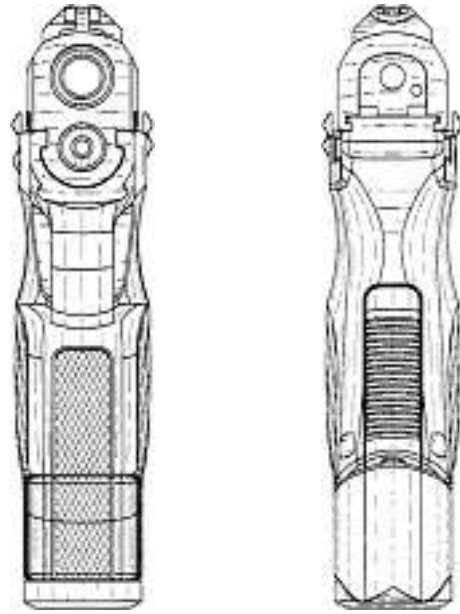
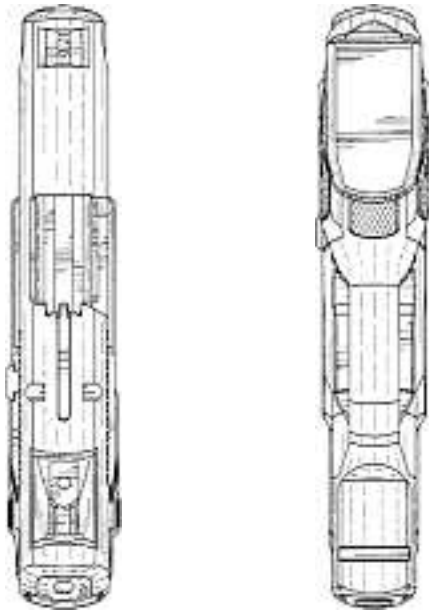

2

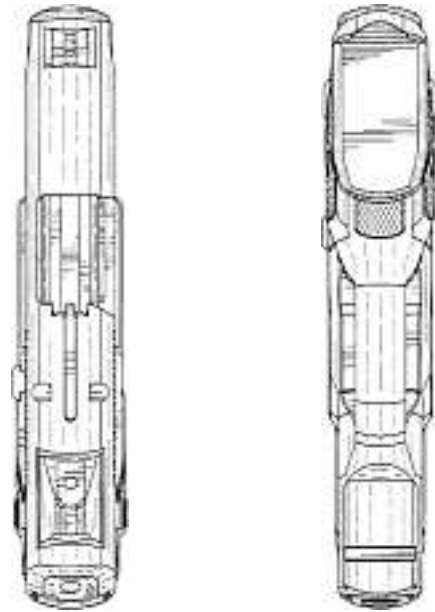

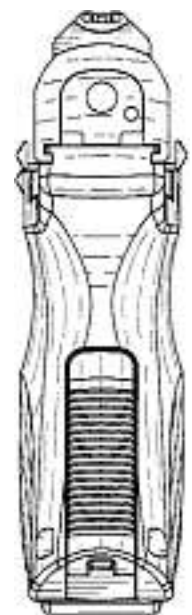
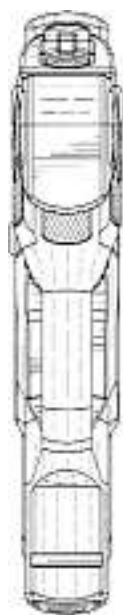
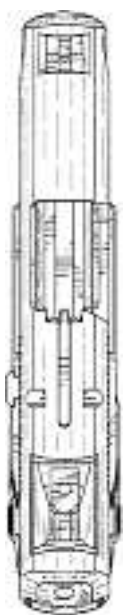
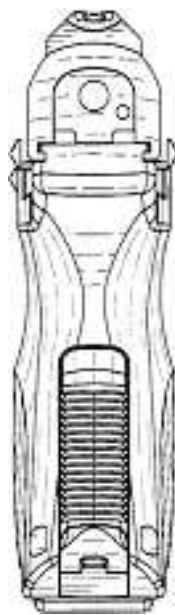
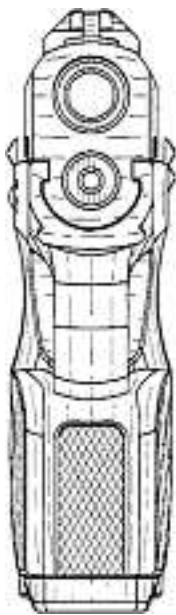

4

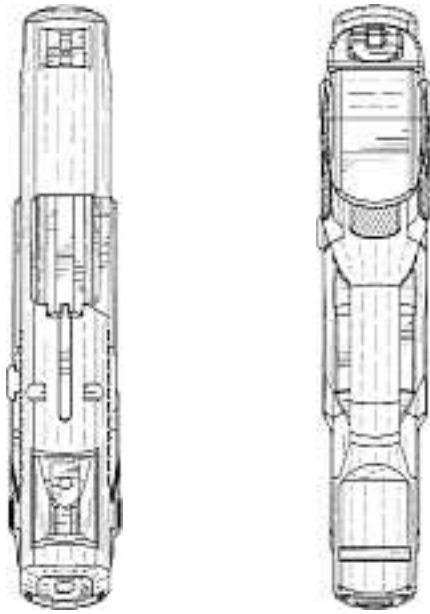

5

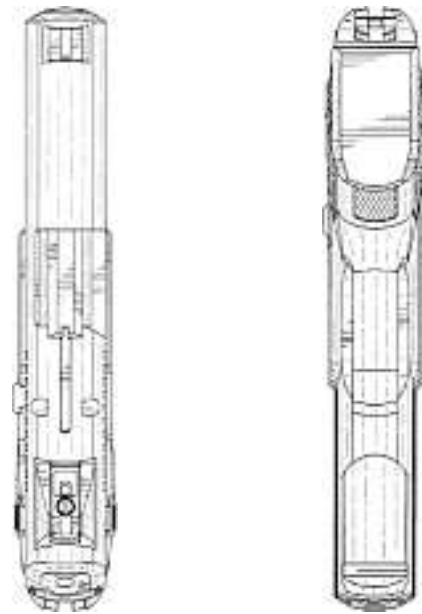
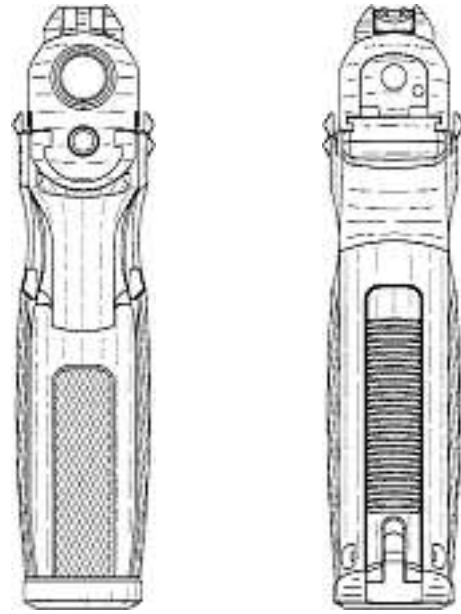



Cl. 23-01, 23-02 **134 736** 21.12.2007
10 Design – Armaturen, Abläufe, Überläufe
Hinterleger: Niro-Plan AG, Franke-Strasse 2, 4663 Aarburg
Designer: Lutz Gebhardt, Zug; Gerd Rüttbauer, Schwörstadt;
Andre Rudolf, Unterkulm
Vertreter: R. A. Egli & Co., Patentanwälte, 8008 Zürich
Priorität: EM, 10.07.2007

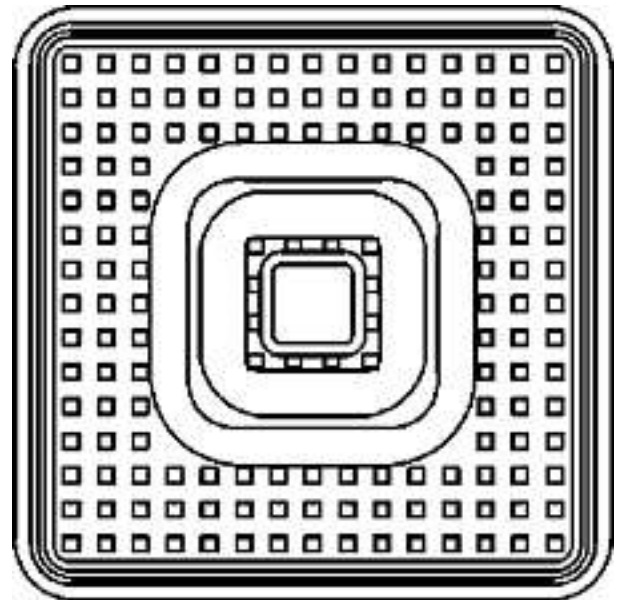
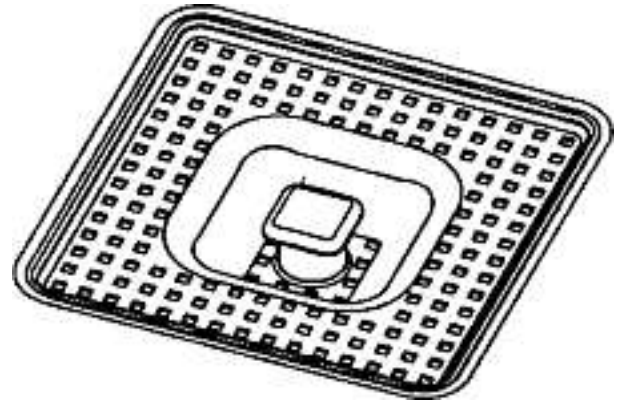
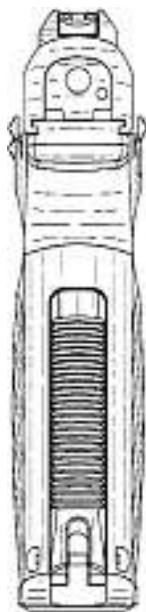
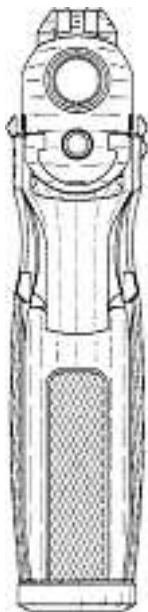

1

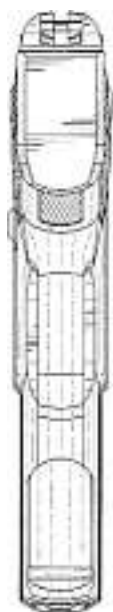

2

6



3

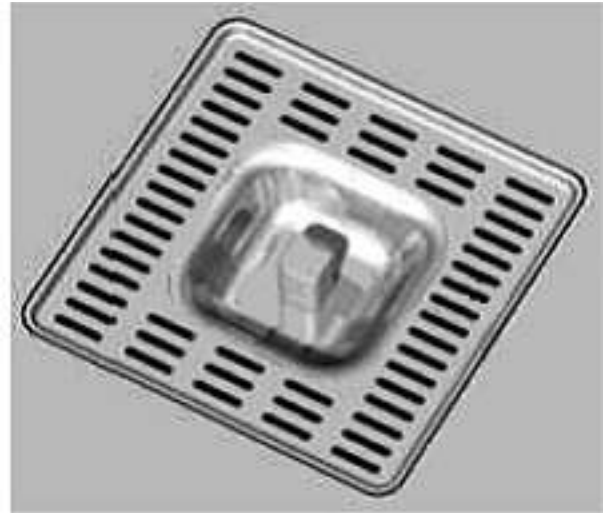

6

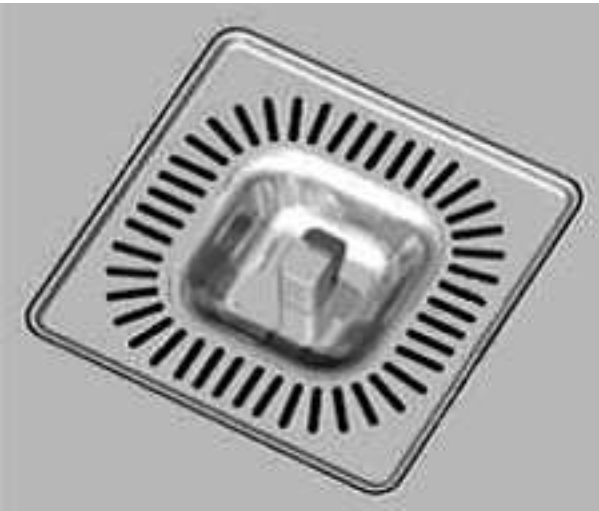

4

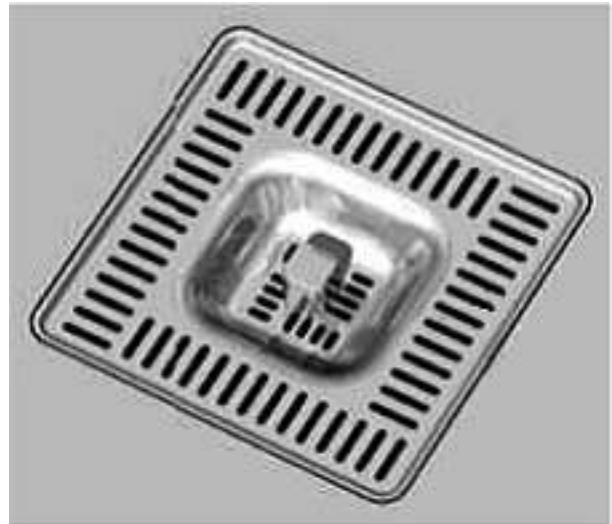

7

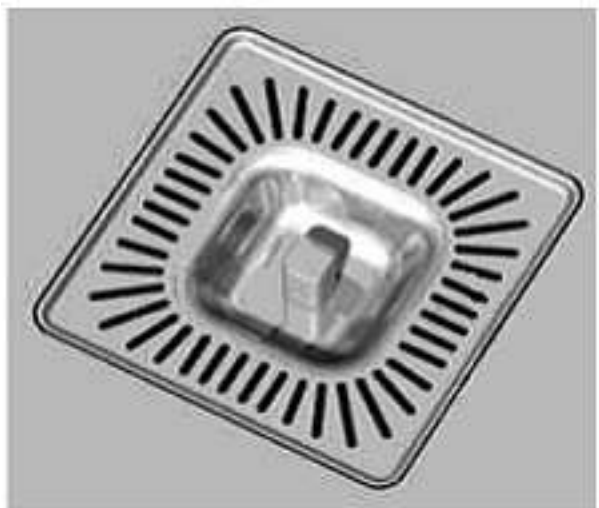

5

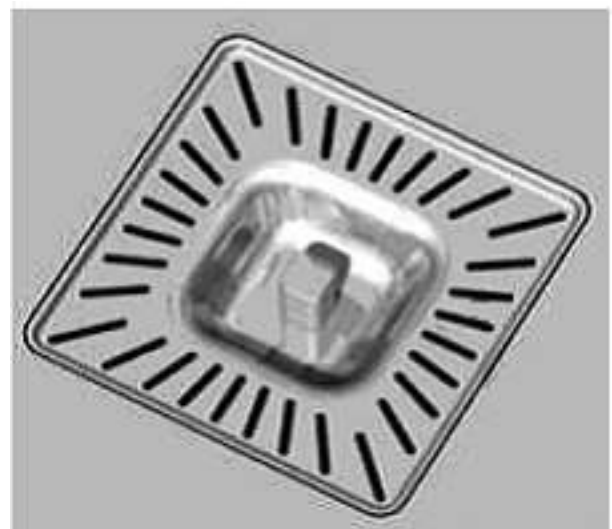

8

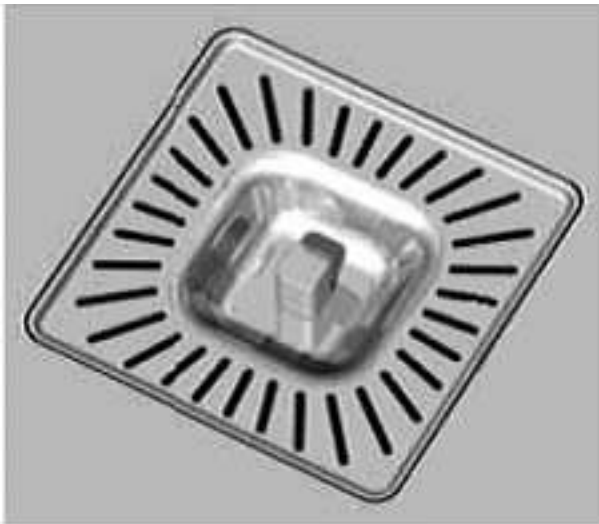

9



10

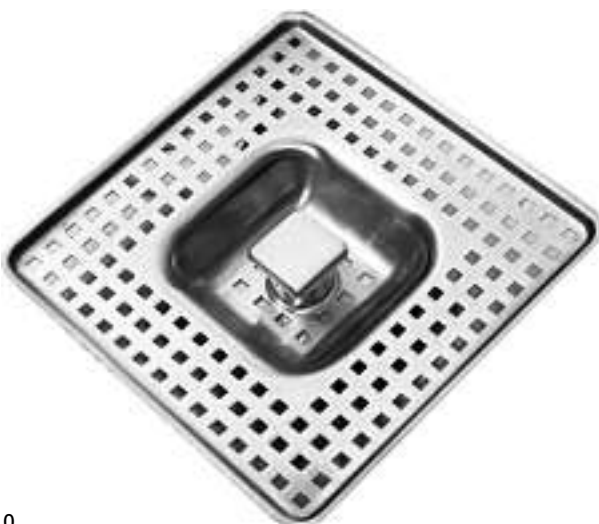

Cl. 23-02 134 737 17.01.2008
 3 Design – Waschbecken
 Hinterleger: Bagno Sasso AG, Schulstrasse 76,
 7302 Landquart
 Designer: Tilo Gnausch, Zürich

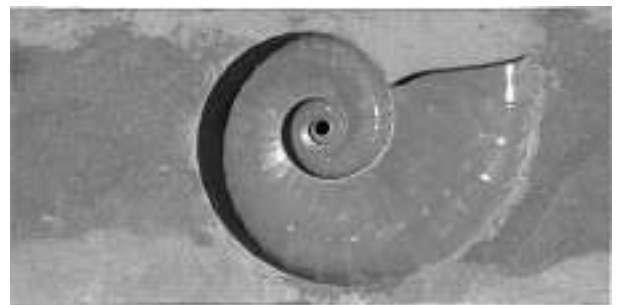

1

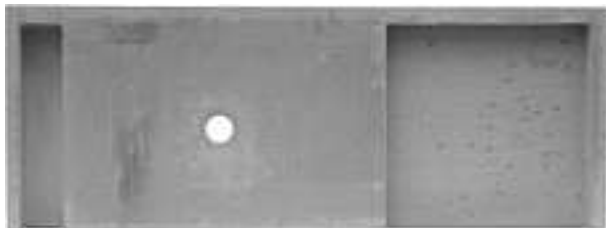
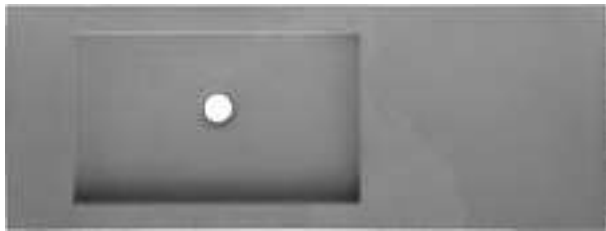

2



3

Cl. 26-05 134 740 18.12.2007
4 Design – Lampen
Hinterleger: Lumess AG, Lettenweg 118, 4123 Allschwil
Designer: Elia Gilli, Basel



42030.01



11060.01

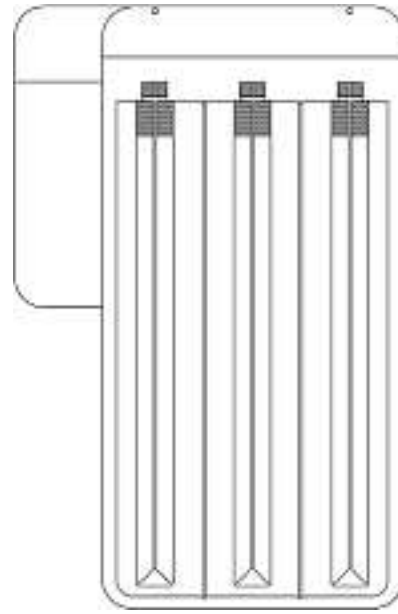
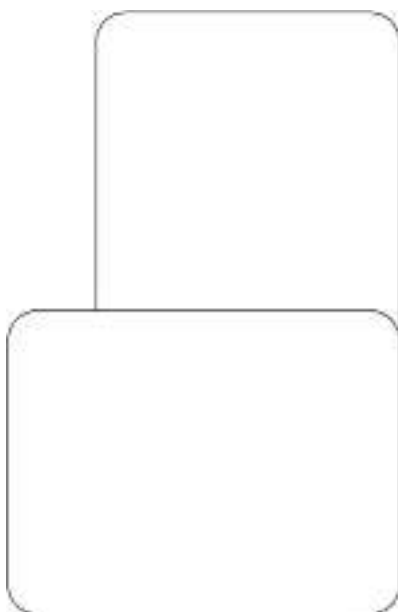
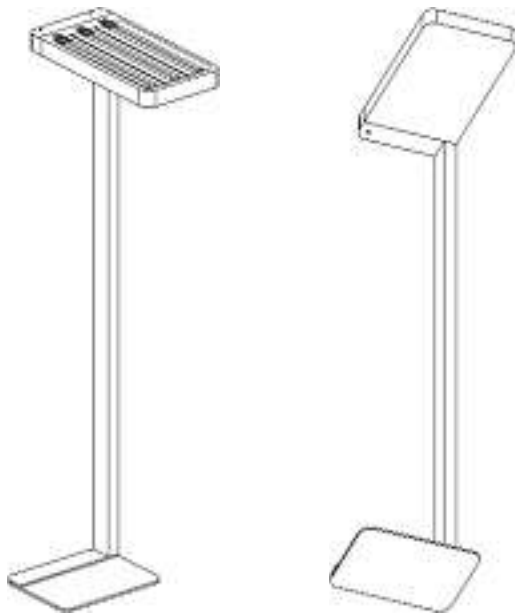

1

Cl. 26-05 **134 743** 11.01.2008
1 Design – Leuchte
Hinterleger: Herbert Waldmann GmbH & Co. KG, Peter-Henlein-Strasse 5, 78056 Villingen-Schwenningen, DE
Designer: Gerhard Waldmann, Dauchingen
Vertreter: R. A. Egli & Co., Patentanwälte, 8008 Zürich
Priorität: DE, 10.08.2007

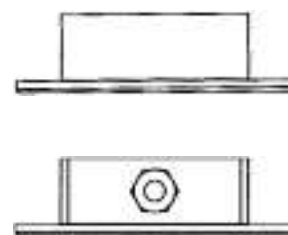



1

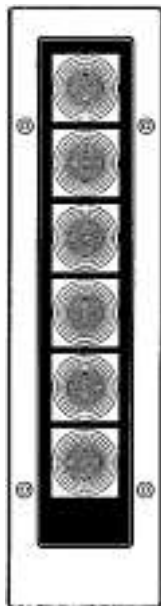

**Verlängerungen
Prolongations
Prolongazioni**

| | | | |
|---------|-----|-------|----------|
| 116 443 | Cl. | 09-05 | 1 Design |
| 116 554 | Cl. | 07-04 | 2 Design |
| 116 557 | Cl. | 09-05 | 1 Design |
| 119 836 | Cl. | 10-01 | 3 Design |



RW1



K 1

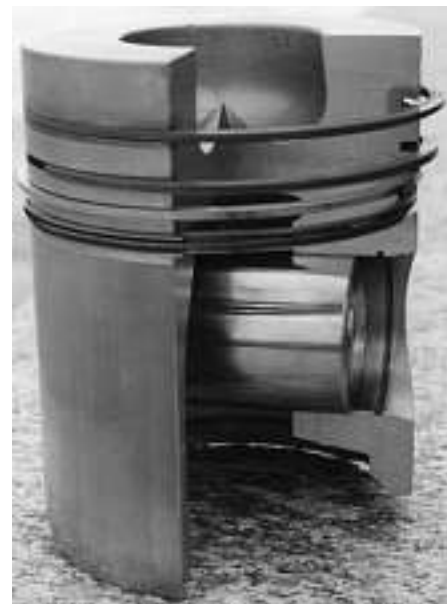



K2

120 146 Cl. 09-03 1 design



1

120 325 Cl. 13-02 2 design

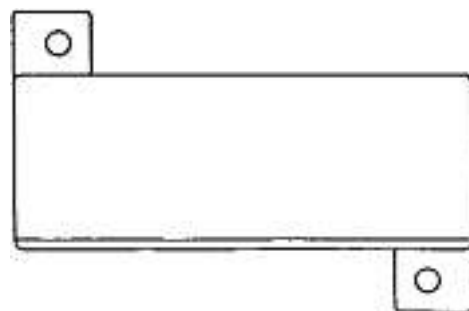
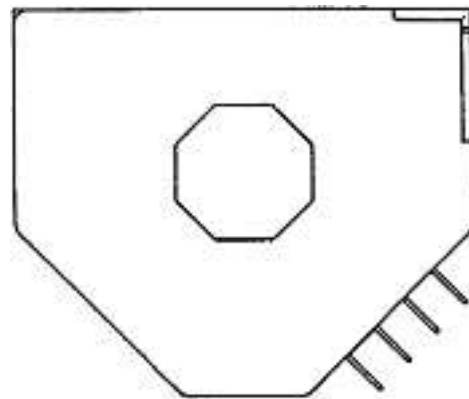
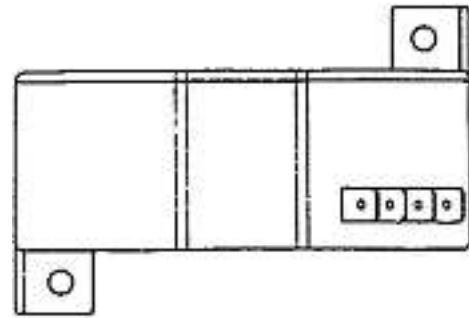
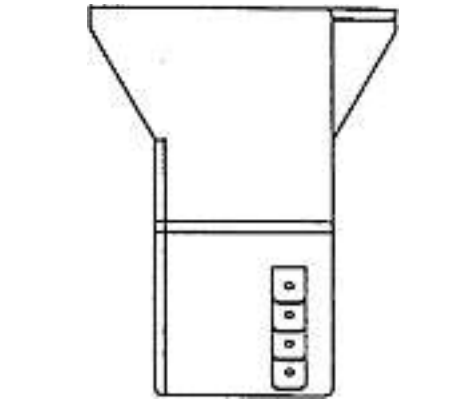
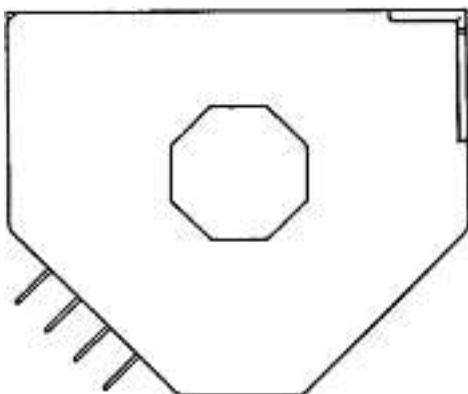

1

120 409 Cl. 09-01 1 Design

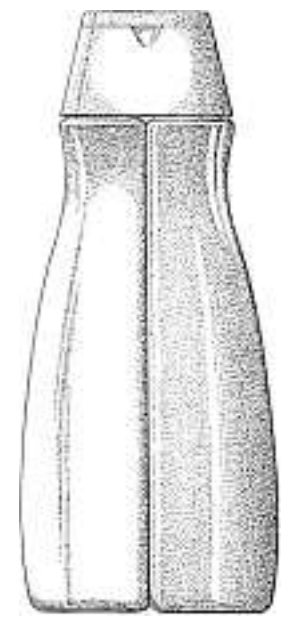
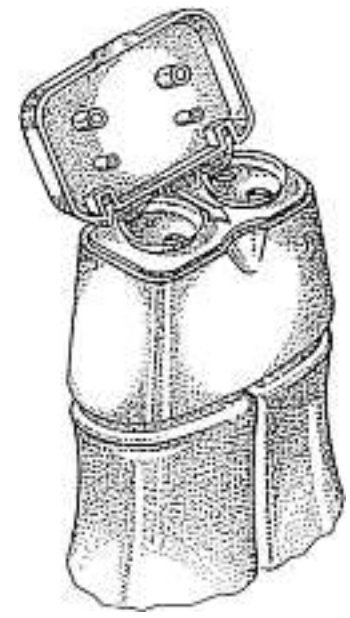
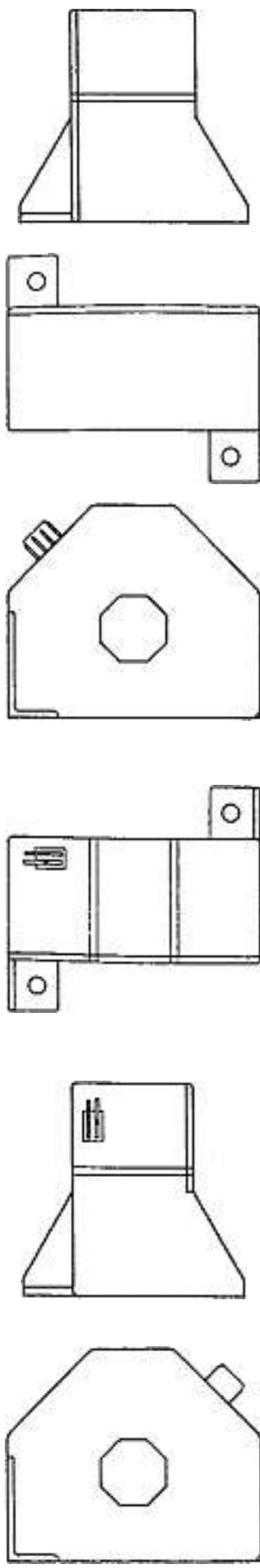

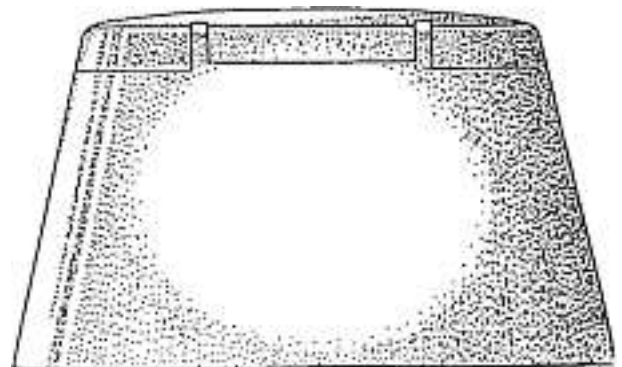
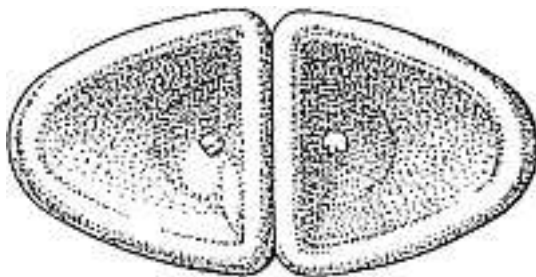
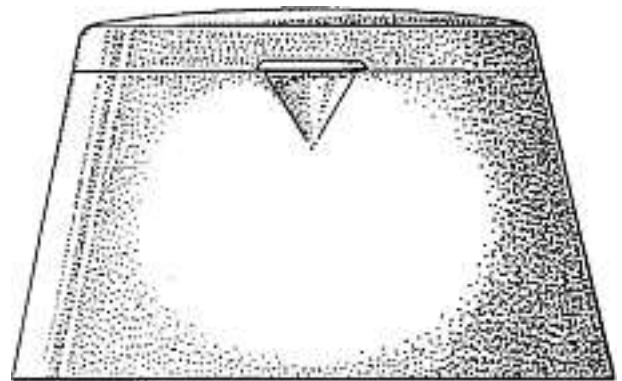
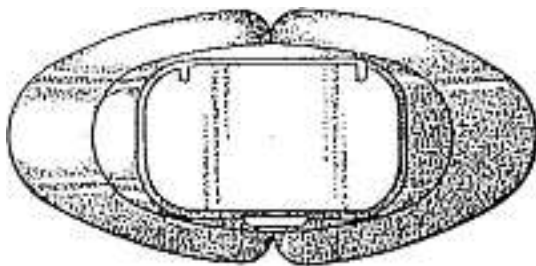
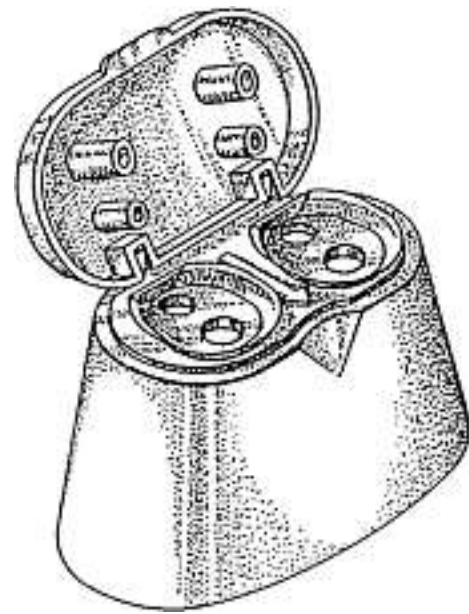

1

120 411 Cl. 09-07 1 Design

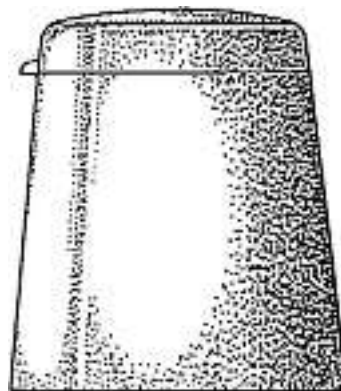
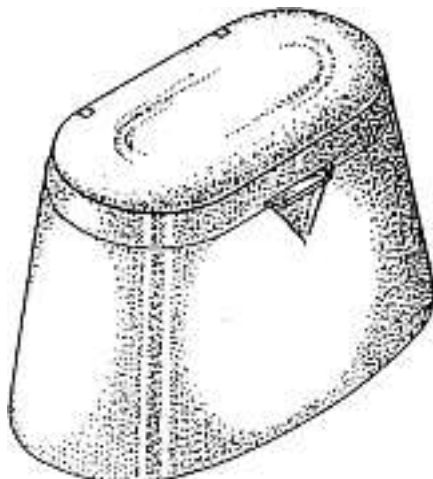

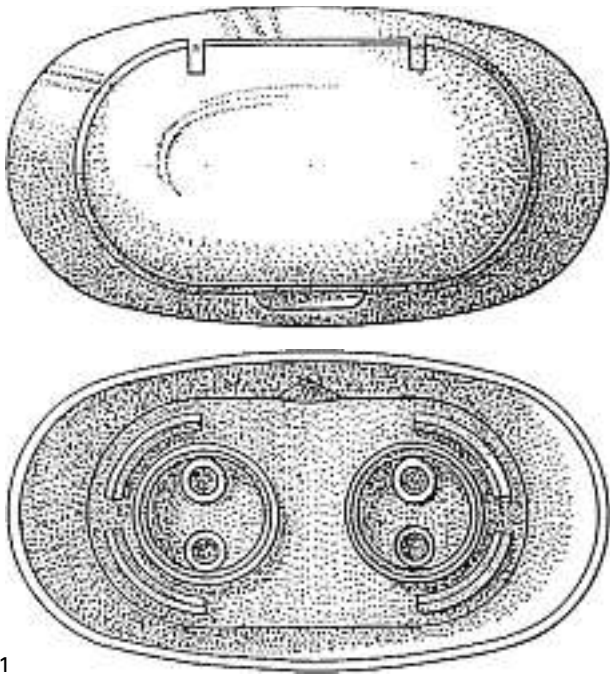

1

120 450 Cl. 09-01 1 Design



1

120 543 Cl. 09-01 2 design

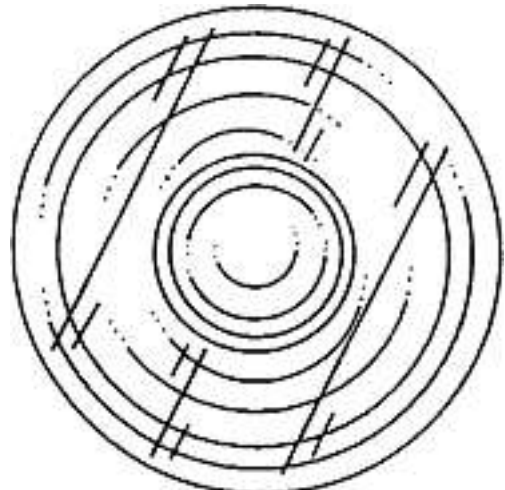
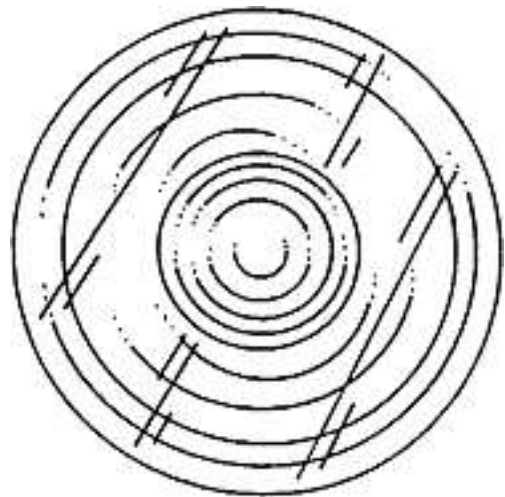
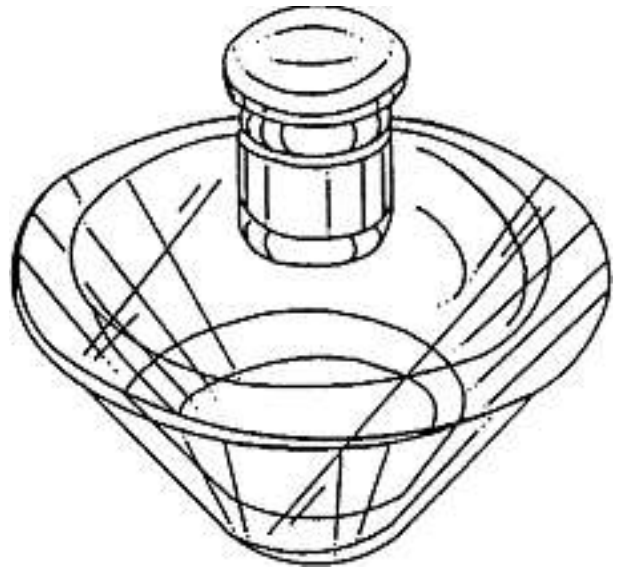
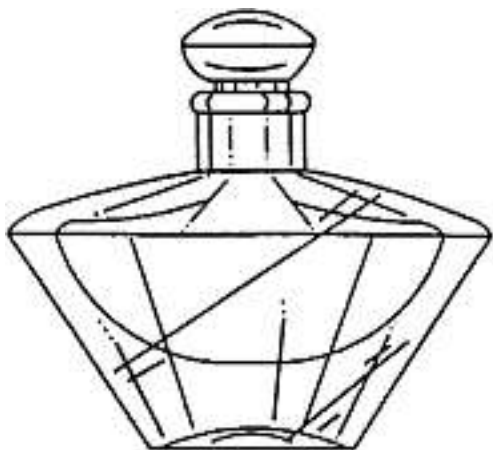

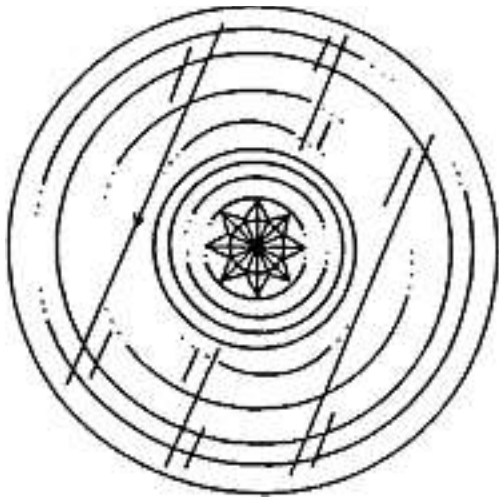

1

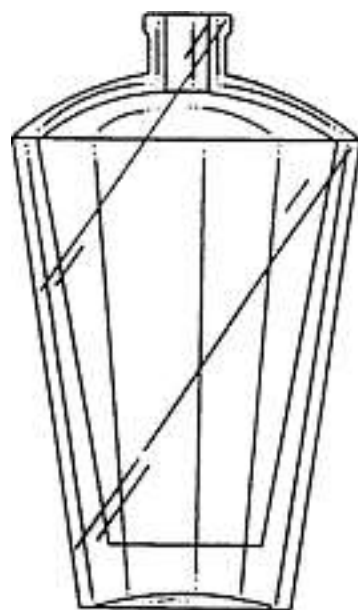
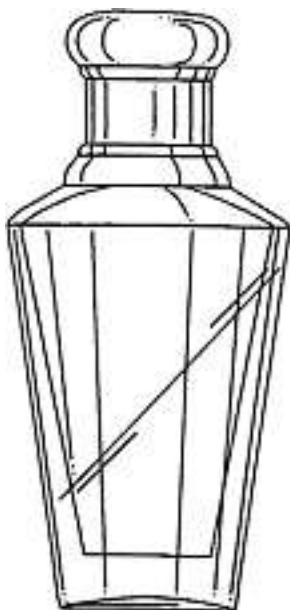
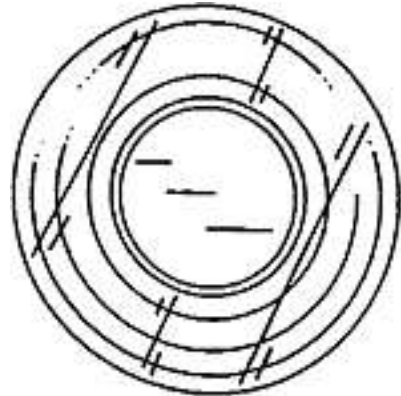
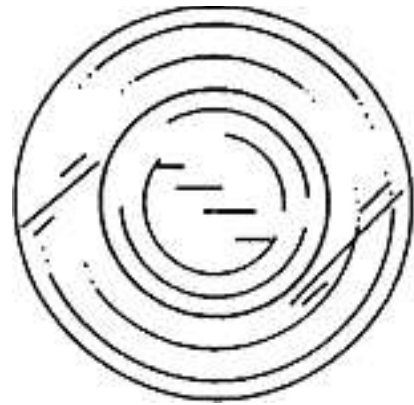

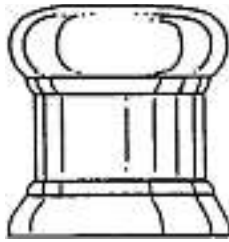

2

| | | | | |
|---------|-----|-------|----|--------|
| 124 811 | Cl. | 07-02 | 4 | Design |
| 124 812 | Cl. | 07-02 | 4 | Design |
| 124 813 | Cl. | 07-02 | 4 | Design |
| 124 844 | Cl. | 07-01 | 1 | Design |
| 124 925 | Cl. | 07-04 | 1 | Design |
| 124 932 | Cl. | 12-12 | 2 | Design |
| 124 954 | Cl. | 04-02 | 1 | Design |
| 124 964 | Cl. | 06-07 | 5 | Design |
| 125 004 | Cl. | 03-01 | 1 | Design |
| 125 049 | Cl. | 04-02 | 1 | Design |
| 125 050 | Cl. | 04-02 | 1 | Design |
| 125 051 | Cl. | 04-02 | 1 | Design |
| 125 052 | Cl. | 04-02 | 1 | Design |
| 125 066 | Cl. | 07-02 | 1 | design |
| 125 092 | Cl. | 24-02 | 1 | design |
| 125 113 | Cl. | 09-01 | 3 | design |
| 125 136 | Cl. | 04-02 | 1 | Design |
| 125 137 | Cl. | 04-02 | 1 | Design |
| 125 169 | Cl. | 19-08 | 2 | Design |
| 129 345 | Cl. | 07-01 | 3 | Design |
| 129 346 | Cl. | 07-01 | 1 | Design |
| 129 347 | Cl. | 07-01 | 1 | Design |
| 129 349 | Cl. | 07-01 | 3 | Design |
| 129 350 | Cl. | 07-01 | 3 | Design |
| 129 351 | Cl. | 07-02 | 1 | Design |
| 129 352 | Cl. | 07-02 | 1 | Design |
| 129 354 | Cl. | 07-04 | 1 | Design |
| 129 360 | Cl. | 09-03 | 12 | Design |
| 129 370 | Cl. | 15-06 | 1 | Design |
| 129 446 | Cl. | 02-04 | 1 | Design |
| 129 464 | Cl. | 06-06 | 2 | Design |
| 129 511 | Cl. | 11-01 | 2 | Design |
| 129 514 | Cl. | 14-03 | 1 | Design |
| 129 524 | Cl. | 25-02 | 4 | design |
| 129 526 | Cl. | 26-02 | 2 | design |
| 129 545 | Cl. | 06-03 | 1 | Design |
| 129 546 | Cl. | 06-03 | 1 | Design |
| 129 553 | Cl. | 07-01 | 1 | Design |
| 129 556 | Cl. | 09-03 | 1 | design |
| 129 586 | Cl. | 25-01 | 1 | Design |
| 129 599 | Cl. | 07-01 | 1 | Design |
| 129 626 | Cl. | 14-02 | 1 | Design |
| 129 627 | Cl. | 14-02 | 1 | Design |
| 129 630 | Cl. | 15-02 | 1 | Design |
| 129 742 | Cl. | 10-01 | 2 | Design |
| 129 748 | Cl. | 19-08 | 2 | Design |

Mutationen Modifications Modificazioni

122 242

Übertragung

Hinterleger: Ultradent Products, Inc., 505 West 10200 South, South Jordan, Utah 84095, US

Vertreter: Ammann Patentanwälte AG Bern, 3001 Bern

125 113

Nouveau mandataire

Mandataire: E. Blum & Co. AG, Patent- und Markenanwälte VSP, 8044 Zürich

127 828

127 936

130 560

Vertreter Firmaänderung

Vertreter: NEOVIUS Schlager & Partner, Advokaten & Notare, 4010 Basel

131 854

Namensänderung

Hinterleger: Acrostak Corp. BVI, c/o Acrostak AG, Stegackerstrasse 14, 8409 Winterthur

132 298

Transmission

Déposant: YSL BEAUTE, 28/34 Boulevard du Parc, 92521 Neuilly-sur-Seine Cedex, FR

Mandataire: Griffes Consulting S.A., 1206 Genève

134 643

Nouveau mandataire

Mandataire: Cabinet Germain & Maureau, 2028 Vaumarcus

**Löschungen
Radiations
Radiazioni**

| | | | |
|---------|-----|-------|----------|
| 116 119 | Cl. | 06-01 | 9 Design |
| 116 120 | Cl. | 07-01 | 2 Design |
| 119 865 | Cl. | 06-03 | 3 Design |
| 119 908 | Cl. | 12-02 | 1 design |
| 124 330 | Cl. | 07-02 | 1 Design |
| 124 372 | Cl. | 07-05 | 1 Design |
| 124 373 | Cl. | 07-05 | 1 Design |
| 124 374 | Cl. | 07-05 | 1 Design |
| 124 399 | Cl. | 24-02 | 1 Design |
| 124 430 | Cl. | 14-02 | 1 Design |
| 124 431 | Cl. | 14-03 | 2 Design |
| 124 435 | Cl. | 20-01 | 1 Design |
| 128 976 | Cl. | 07-04 | 1 Design |
| 128 977 | Cl. | 07-99 | 3 Design |
| 128 983 | Cl. | 09-03 | 1 Design |
| 128 984 | Cl. | 10-02 | 1 Design |
| 128 986 | Cl. | 13-02 | 1 design |
| 128 990 | Cl. | 30-03 | 3 Design |
| 129 006 | Cl. | 11-02 | 1 Design |
| 129 015 | Cl. | 19-08 | 1 design |
| 129 047 | Cl. | 09-04 | 1 Design |
| 129 074 | Cl. | 09-05 | 2 Design |
| 129 085 | Cl. | 25-01 | 1 Design |

**Berichtigungen
Rectifications
Rettifiche**

134 209
Rettifica del depositante:
Jal Group Italia s.r.l.