

## Nationale Hinterlegungen

In der folgenden Liste werden die beim Eidgenössischen Institut für Geistiges Eigentum hinterlegten Designs publiziert. Dabei sind der Reihe nach angegeben:

- internationale Klassenangaben
- Hinterlegungsnummer
- Hinterlegungsdatum
- Allenfalls Aufschub der Veröffentlichung
- Anzahl der hinterlegten Designs
- Bezeichnung
- Name und Wohnsitz des Hinterlegers oder der Hinterlegerin
- gegebenenfalls Name und Wohnsitz des Designers oder der Designerin
- Name und Geschäftssitz des allfälligen Vertreters oder der Vertreterin
- gegebenenfalls Prioritätsangaben
- gegebenenfalls Beschreibungstext
- Ordnungsnummer
- Reproduktion des Designs

## Internationale Hinterlegungen

Die bei der Weltorganisation für geistiges Eigentum in Genf hinterlegten Muster und Modelle mit Benennung Schweiz geniessen den gleichen Schutz wie national hinterlegte Designs. Sie werden jeweils im Blatt «Bulletin des dessins et modèles internationaux» veröffentlicht. Dieses Publikationsorgan ist deshalb für eine vollständige Recherche unbedingt beizuziehen.

## Topographien

Angaben über die vom Eidgenössischen Institut für Geistiges Eigentum eingetragenen Topographien von Halbleitererzeugnissen werden in folgender Anordnung aufgeführt:

- Eintragsnummer
- Anmeldedatum
- Bezeichnung
- Name und Wohnsitz des Anmelders oder der Anmelderin
- gegebenenfalls Name und Wohnsitz des Herstellers oder der Herstellerin
- Name und Geschäftssitz des oder der allfälligen Bevollmächtigten
- Datum und Ort einer allfälligen ersten geschäftlichen Verbreitung der Topographie

## Dépôts nationaux

Les designs déposés à l'Institut Fédéral de la Propriété Intellectuelle sont publiés dans la liste qui suit. Les indications y relatives sont mentionnées dans cet ordre:

- indications des classes internationales
- numéro de dépôt
- date de dépôt
- le cas échéant, ajournement de la publication
- nombre des designs déposés
- désignation
- nom et domicile du/de la déposant/e
- le cas échéant, nom et domicile du/de la designer
- nom et domicile de l'éventuel/le mandataire
- le cas échéant, indication de priorité
- le cas échéant, description du design
- numéro attribué à chaque design
- reproduction du design

## Dépôts internationaux

Les dessins et modèles déposés à l'Organisation Mondiale de la Propriété Intellectuelle à Genève qui désignent la Suisse jouissent de la même protection que les dépôts nationaux. Ils sont chaque fois publiés dans la feuille «Bulletin des dessins et modèles internationaux». Pour une recherche complète, il est indispensable de consulter ledit organe de publication.

## Topographies

Les indications concernant les topographies des produits semi-conducteurs, enregistrées par l'Institut Fédéral de la Propriété Intellectuelle, sont énumérées dans l'ordre suivant:

- numéro d'enregistrement
- date de dépôt
- désignation
- nom et domicile du/de la déposant/e
- le cas échéant, nom et domicile du/de la producteur/trice
- nom et domicile de l'éventuel/le mandataire
- date et lieu d'une éventuelle première mise en circulation de la topographie

## Depositi nazionali

Nella lista seguente vengono pubblicati i design depositati presso l'Istituto Federale della Proprietà Intellettuale. Sono menzionati nel seguente ordine:

- indicazioni delle classi internazionali
- numero di deposito
- data del deposito
- se del caso, indicazione che la pubblicazione è stata differita
- numero dei design depositati
- designazione
- nome e domicilio del depositante
- se del caso, nome e domicilio del designer
- nome e sede di un eventuale mandataro
- se del caso, indicazioni di priorità
- se del caso, descrizione del design
- numero d'ordine
- riproduzione del design

## Depositi internazionali

I disegni e modelli depositati presso l'Organizzazione Mondiale della Proprietà Intellettuale a Ginevra con denominazione Svizzera godono della medesima protezione del deposito nazionale. Essi vengono pubblicati ogni volta nel foglio «Bulletin des dessins et modèles internationaux». Quest'organo di pubblicazione è da consultare se si vuole effettuare una ricerca completa.

## Topografie

Le indicazioni concernenti le topografie di prodotti a semiconduttori depositati presso l'Istituto Federale della Proprietà Intellettuale sono menzionate nell'ordine seguente:

- numero di registrazione
- data del deposito
- designazione
- nome e domicilio del/la richiedente
- se del caso, nome e domicilio del/la produttore/trice
- nome e sede di un eventuale mandataro
- data e luogo di un'eventuale prima messa in circolazione della topografia

**Hinterlegungen**  
**Dépôts**  
**Deposit**

Cl. 11-01                      130 777                      14.06.2004  
96 Design – Ringe  
Hinterleger: Furrer-Jacot AG, Feldstrasse 30,  
8201 Schaffhausen  
Designer: Lucas Ruppli, Schaffhausen  
Ende aufgeschobene Publikation



78-60000



78-60010



78-10010



78-10000



78-60020



78-10020



78-60040



78-60030



78-10040



78-10030



78-60050



78-10050



78-60070



78-60060



78-10070



78-10060



78-60080



78-10080



78-60100



78-60090



78-10100



78-10090



78-60110



78-10110



78-60130



78-60120



78-10130



78-10120



78-60140



78-10140



78-60160



78-60150



78-10160



78-10150



78-60170



78-10170



78-60190



78-60180



78-10190



78-10180



78-60200





78-10200



78-60220



78-60210



78-10220



78-10210



78-60230



78-10230



78-60250



78-60240



78-10250



78-10240



78-60260



78-10260



78-60280



78-60270



78-10280



78-10270



78-60290



78-10290



78-10310



78-60300



78-60400



78-10300



78-10400



78-60310



78-60410



78-10410



78-60430



78-10430



78-60420



78-60440



78-10420



78-10440



78-60450



78-10460



78-10450



78-60470



78-10470



78-60460



78-60480



78-10480



78-60500



78-60490



78-10500



78-10490



78-60510



78-10510



78-60530



78-60520



78-10530



78-10520



78-60540





78-10540



78-60550



78-10550

Cl. 06-04

130 854

01.07.2004

1 Design – Regal

Hinterleger: Bruno Messerli, Hauptstrasse 106, Brittern,  
4587 Aetingen

Ende aufgeschobene Publikation





Cave-Rack

Cl. 10-07 **130 912** 27.08.2004  
 1 design – boîte de montre  
 Déposant: Ball Watch Company SA, c/o Leonard SA, 41 A, route de Chêne, 1208 Genève  
 Designer: Henry Duong, Hong Kong  
 Mandataire: Inteltech SA, 2001 Neuchâtel  
 Fin de la période ajournement de la publication

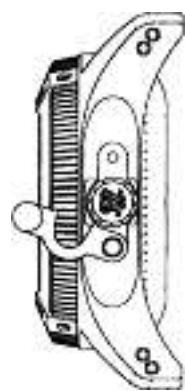
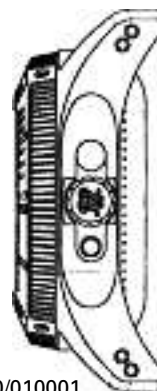
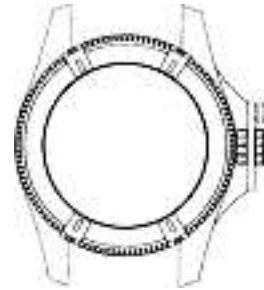

150800/010001

Cl. 02-04 **133 422** 24.11.2006  
 1 Design – Gleitschützer für Schuhe  
 Hinterleger: Devisys OY, PL 137, Tampere, FI  
 Designer: Kari Nikander, Lempäälä  
 Vertreter: Luchs & Partner, Patentanwälte, 8002 Zürich  
 Priorität: EM, 01.06.2006

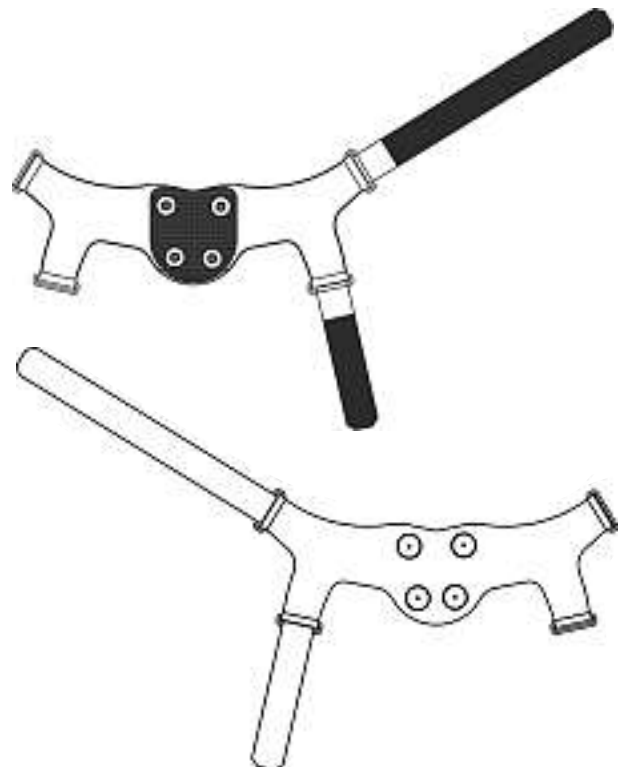

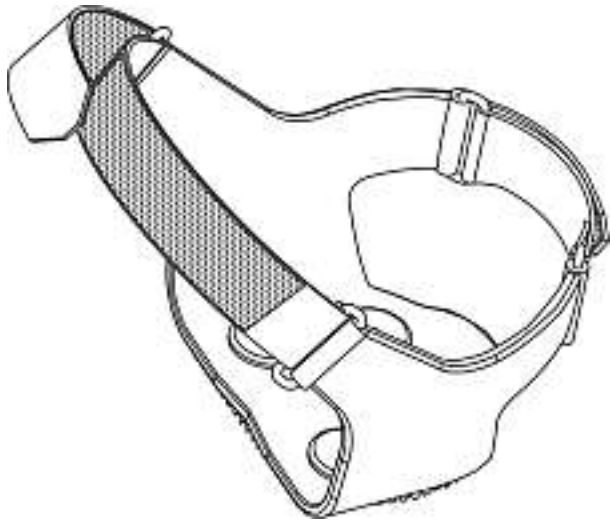
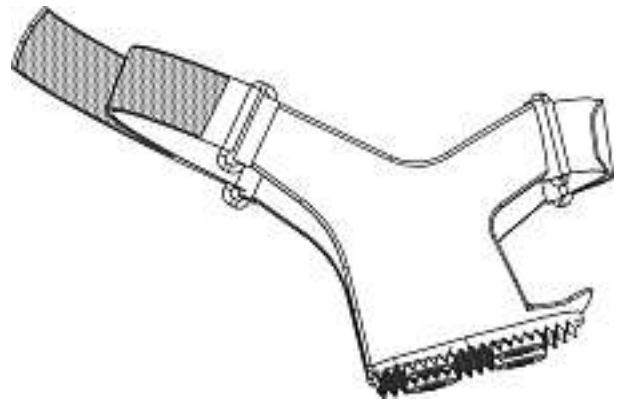
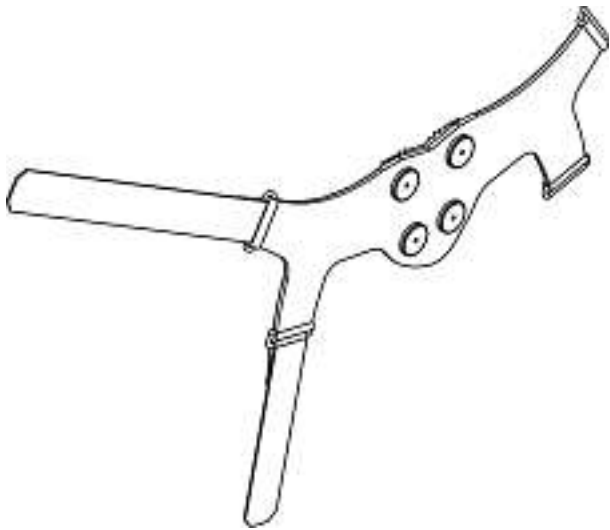

1

Cl. 03-01 **133 423** 23.11.2006  
 3 Design – Behälter für medizinische Geräte  
 Hinterleger: Nycomed Danmark ApS, Langebjerg 1,  
 4000 Roskilde, DK  
 Designer: Anette Heymann Andersen, Holte; Birgitte  
 Stubbjær Nielsen, Charlottenlund; Ronnie Lindström, Malmö  
 Vertreter: Bovard AG, 3000 Bern 25  
 Priorität: EM, 30.05.2006



1

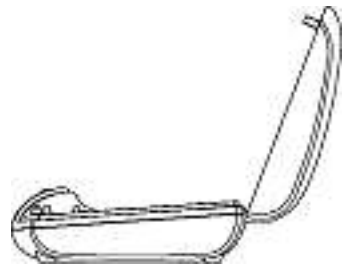
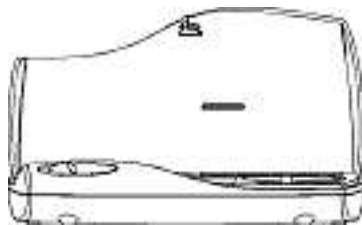
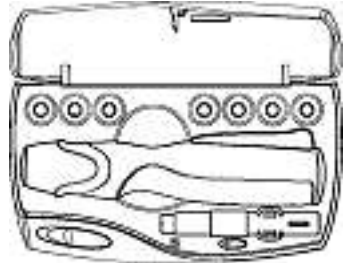

2



3

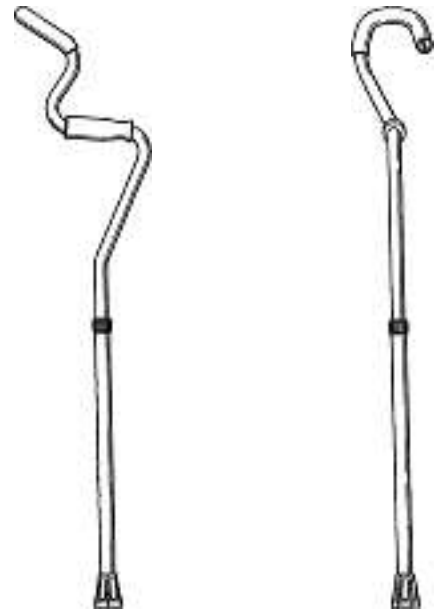
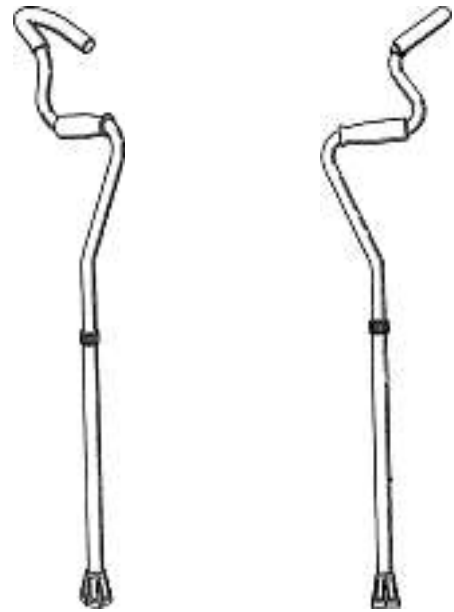

Cl. 03-03 133 424 17.11.2006  
 4 Design – Mobilitätshilfe  
 Hinterleger: StrongArm Inc., 13000 W. Heiden Circle,  
 Suite 3209, Lake Bluff / IL, US  
 Designer: Michael E. Adams, Chicago  
 Vertreter: E. Blum & Co. AG, Patent- und Markenanwälte  
 VSP, 8044 Zürich  
 Priorität: US, 17.05.2006

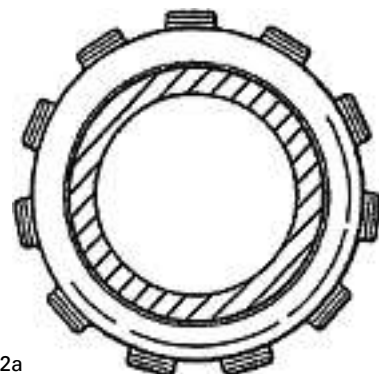
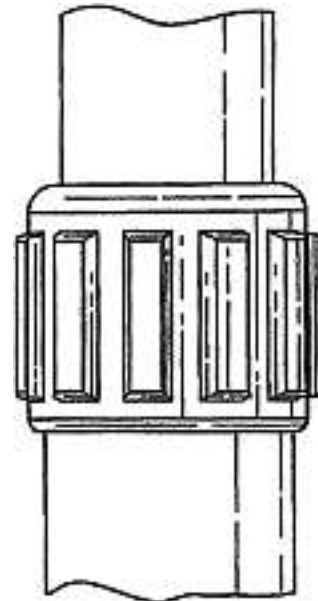
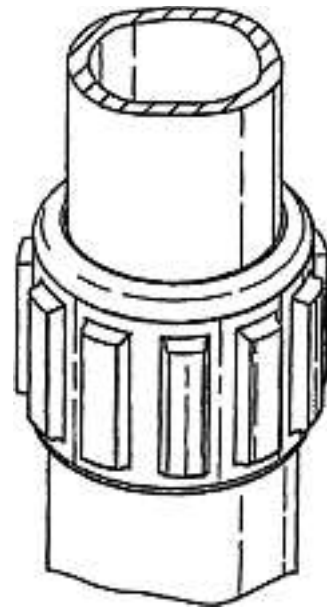
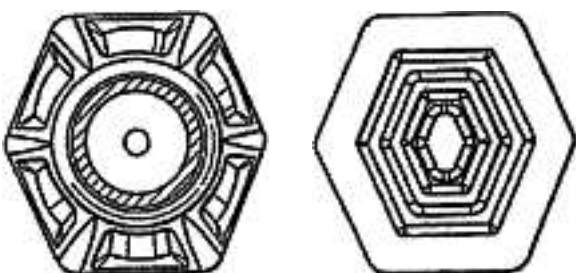
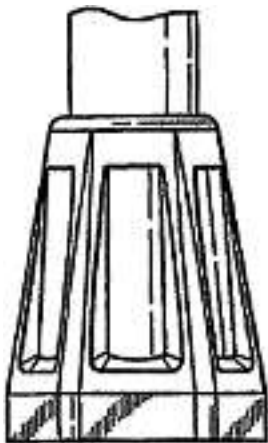
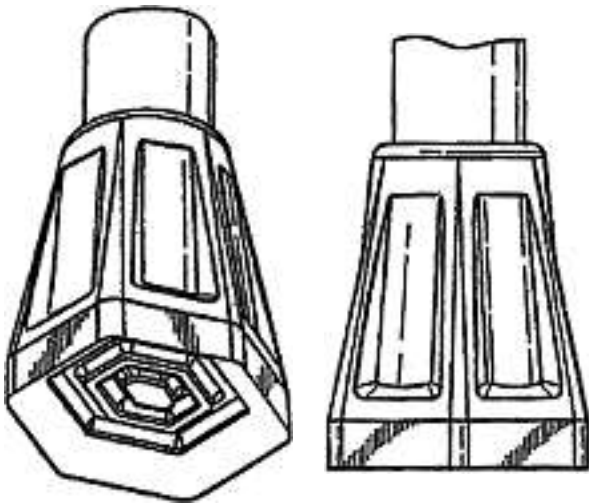
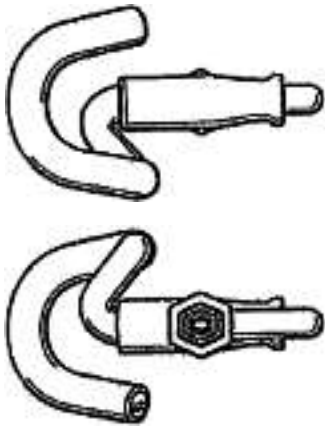

A-2006/1042a

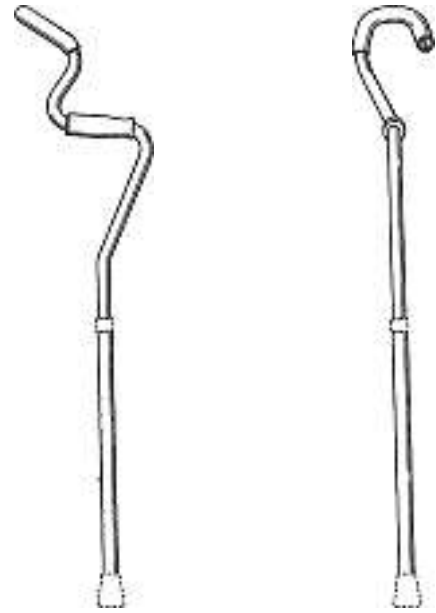
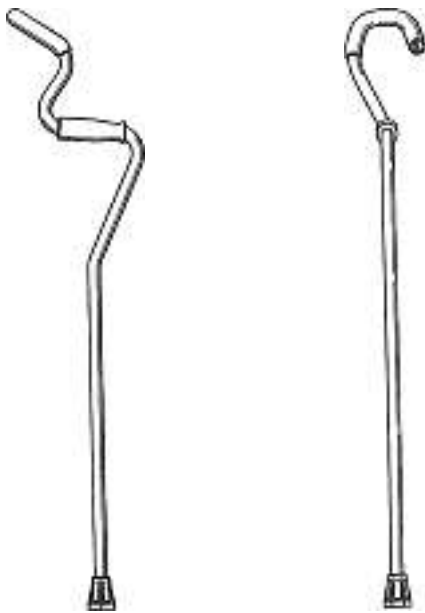
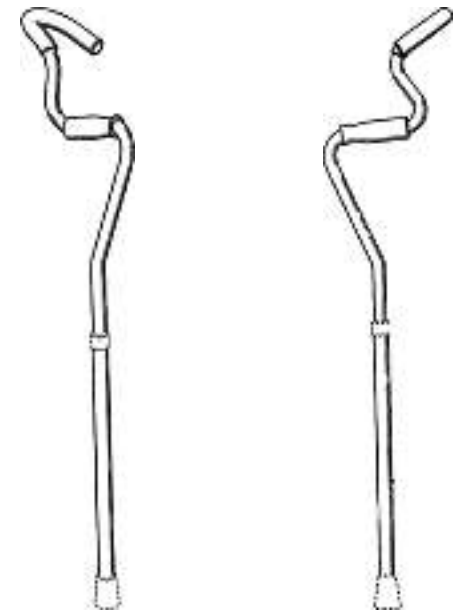
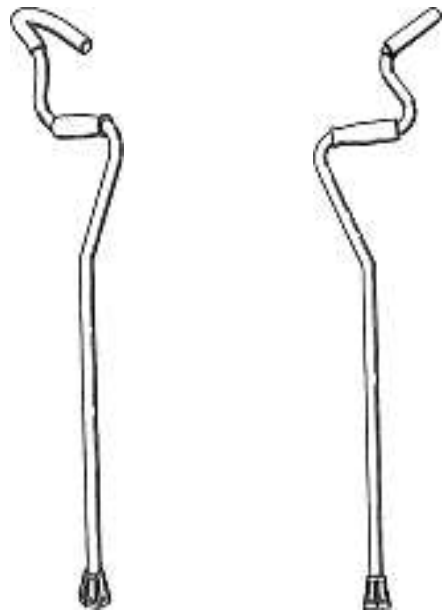

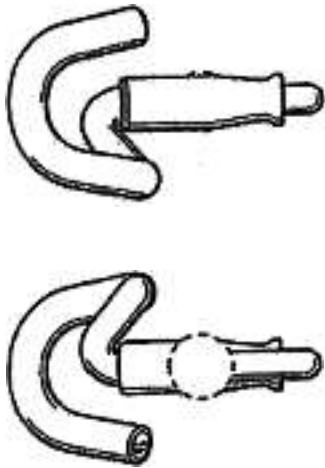

A-2006/1042c

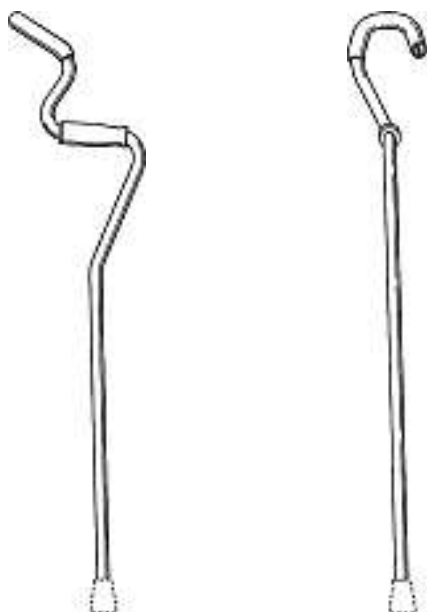
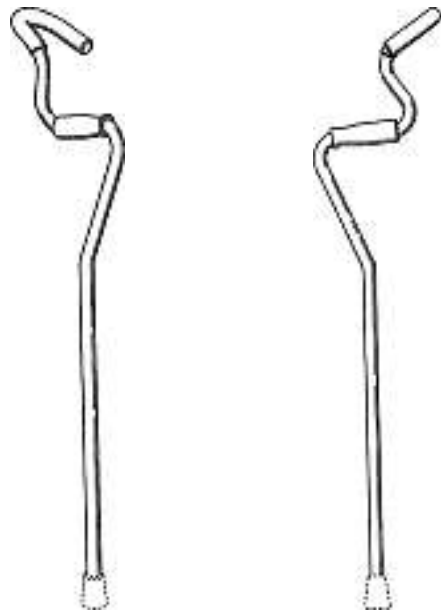

A-2006/1042d

Cl. 04-01 **133 425** 22.11.2006  
 36 Design – Schrubberformen mit Kratzkante  
 Hinterleger: Bürstenfabrik Ebnat-Kappel AG,  
 Industriestrasse 34, 9642 Ebnat-Kappel  
 Designer: Daniel Lutz, Nesslau  
 Vertreter: Patentanwälte Schaad, Balass,  
 Menzl & Partner AG, 8034 Zürich



1A

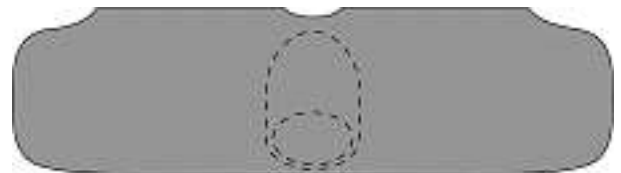

1B

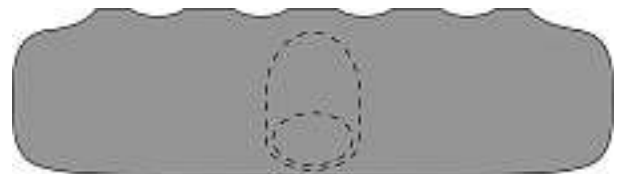

1C



1D



1E

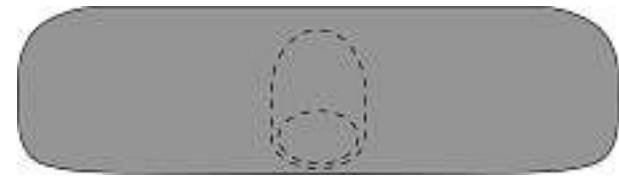

1F



2A



2B



2C



2D



2E



2F

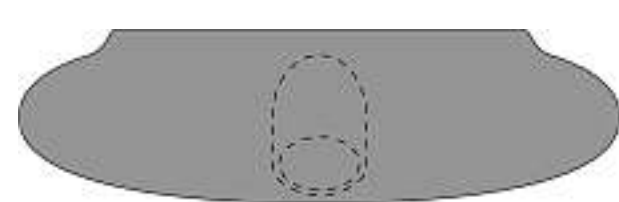

3A



3B



3C

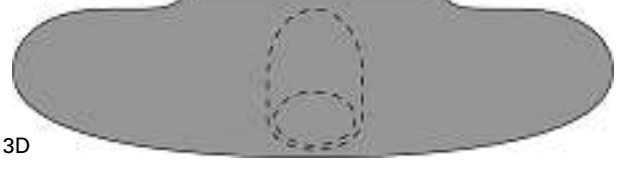

3D



3E

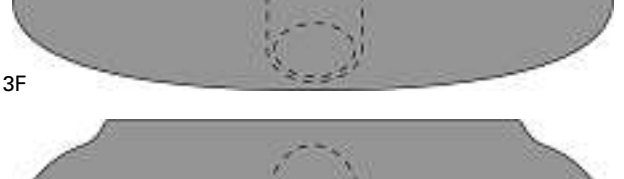

3F



4A



4B



4C



4D



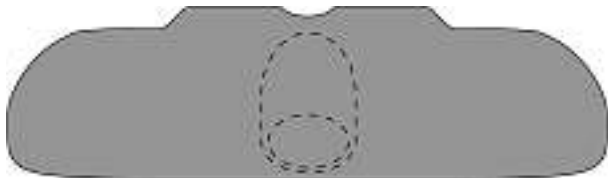

4E



4F



5A

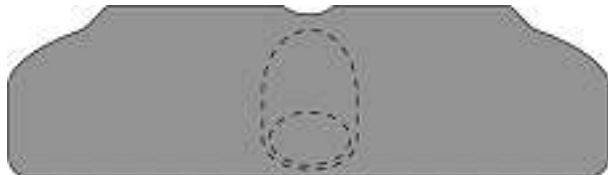

5B



5C



5D



5E



5F

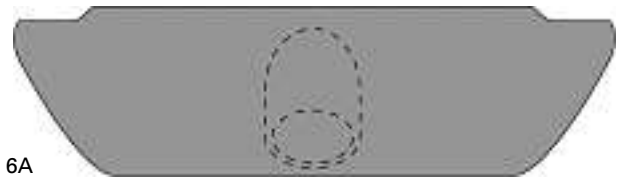

6A



6B



6C



6D



6E



6F

Cl. 06-01 133 426 17.11.2006

6 Design – Sitzmöbel; Kombinierte Möbel  
 Hinterleger: MCA-Agentur Establishment, Industriestrasse 4,  
 Bendorf-Gamprin, LI  
 Designer: Kurt Beier, Michelau  
 Vertreter: BÜCHEL, KAMINSKI & PARTNER  
 PATENTANWÄLTE ESTABLISHMENT, Vaduz (LI),  
 Zweigniederlassung Frümser, 9467 Frümser



1





2



3



4



5





6

Cl. 06-01, 06-04 133 427 27.11.2006  
5 Design – Sessel, Stuhl, Regal  
Hinterleger: LaborPlan GmbH, Ringstrasse 39, 4106 Therwil  
Designer: Hans Walther, Allschwil



Cube 1



Cube 2



Matstram





Quadro



Sprout

Cl. 06-01, 06-03, 06-04 133 428 27.11.2006  
6 Design - Tische, Sideboard, Bank  
Hinterleger: Thomas Schelker, Steinfeldstrasse 34,  
5033 Buchs; Urs Meier, Burghaldenstrasse 16, 5600 Lenzburg  
Vertreter: Urs Meier, 5600 Lenzburg



Z-line 1



Z-line 2



Z-line 3



Z-line 4



Z-board

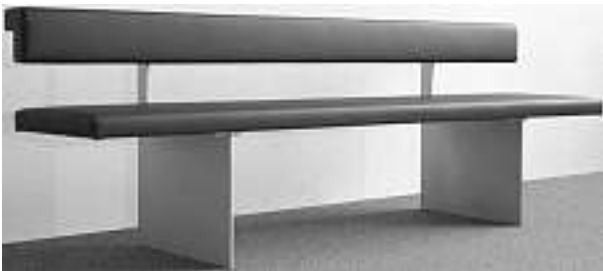

Z-lit

Cl. 06-03, 06-06      **133 429**      02.11.2006  
 3 Design – Tische und Teile davon  
 Hinterleger: Flötotto Brand GmbH, Senner Strasse 32,  
 33335 Gütersloh, DE  
 Designer: Wolfgang Putz, Hessisch Oldendorf  
 Vertreter: Patentanwalt Dipl.-Ing. Wolfgang Heisel,  
 8570 Weinfeldern  
 Priorität: EM, 18.05.2006

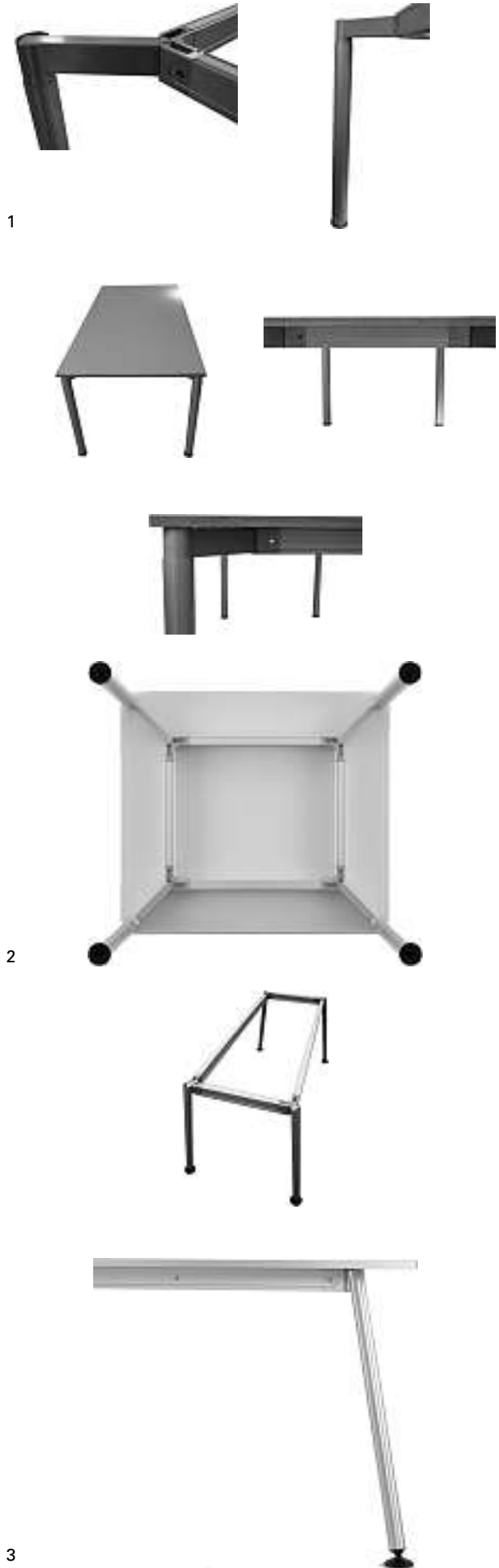

Cl. 06-03 133 430 02.11.2006  
 1 Design – Tisch  
 Hinterleger: Marc Geissmann Möbel- und  
 Projektentwicklung, Dammstrasse 18, 6300 Zug  
 Designer: Marc Geissmann, Zug



Stecktisch Mod. 06

Cl. 06-04 133 431 16.11.2006  
 1 Design – Flaschengestell  
 Hinterleger: Thomas Niederberger, Bärenmatte 4,  
 6403 Küssnacht am Rigi

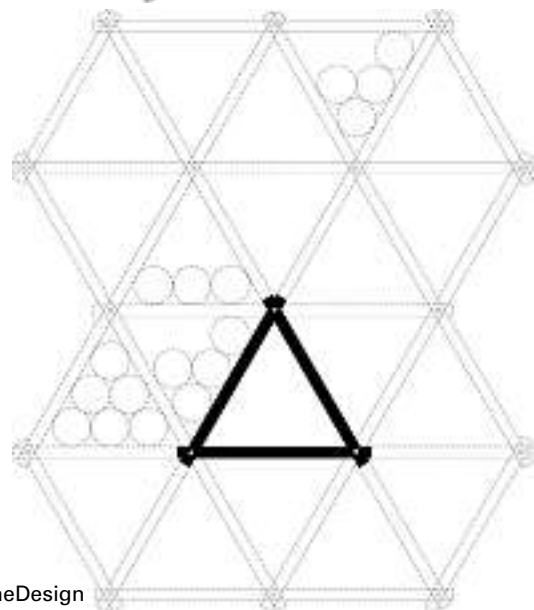

WineDesign



Cl. 06-06 133 432 27.11.2006  
 1 Design – Raumtrenner  
 Hinterleger: Toffol Architekten AG, Riehenstrasse 43,  
 4058 Basel  
 Designer: Stefan Knüsel, Riehen

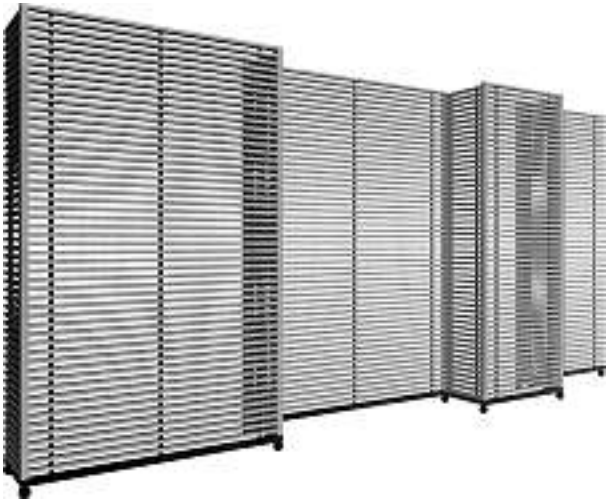

1

Cl. 07-01 133 433 24.11.2006  
 6 Design – Trinkgläser, Tassen, Becher  
 Hinterleger: PI-DESIGN AG, Kantonsstrasse 100,  
 6234 Triengen  
 Designer: Jorgen Bodum, St. Niklausen  
 Vertreter: Isler & Pedrazzini AG, 8023 Zürich  
 Priorität: DK, 22.06.2006





M13256-1



M13256-2





M13256-3

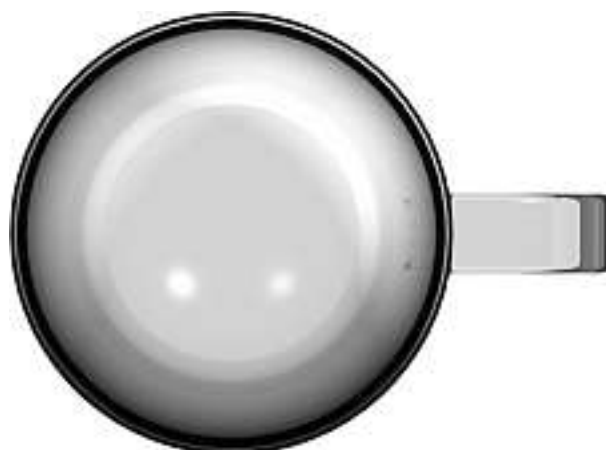



M13256-4



M13256-5



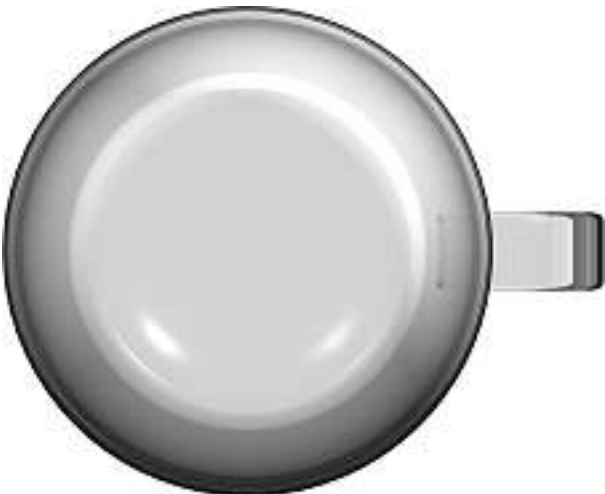

M13256-6

Cl. 07-01

133 434

29.11.2006

1 design – bocal

Déposant: Société des Produits Nestlé SA, 1800 Vevey

Designer: David Francis, Paddington

Mandataire: Nestec S.A., 1800 Vevey

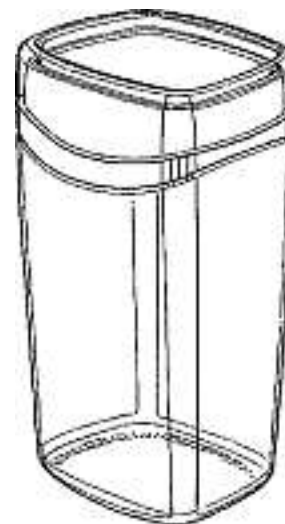
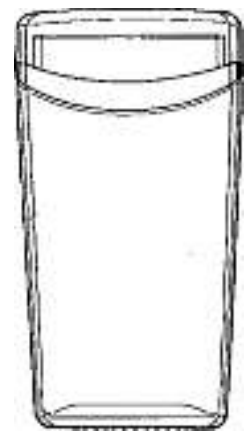

FL 63423

Cl. 07-01 133 435 29.11.2006  
 1 design – bocal  
 Déposant: Société des Produits Nestlé SA, 1800 Vevey  
 Designer: David Francis, Paddington  
 Mandataire: Nestec S.A., 1800 Vevey

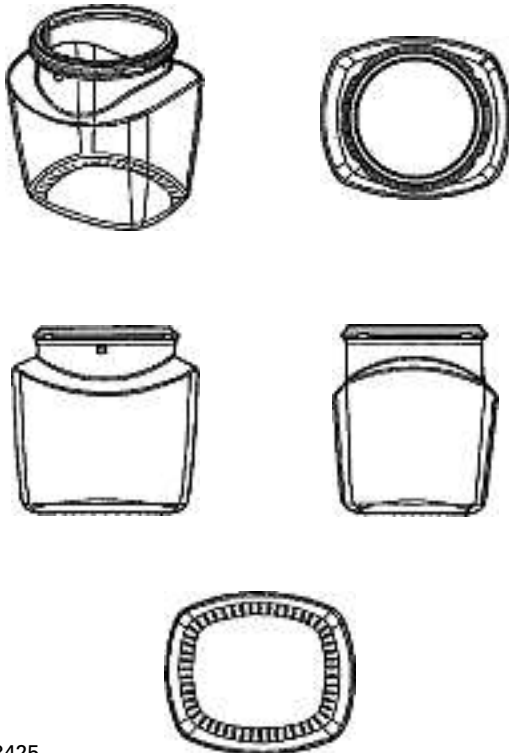

FL 63425

Cl. 07-01 133 436 29.11.2006  
 1 design – bocal  
 Déposant: Société des Produits Nestlé SA, 1800 Vevey  
 Designer: David Francis, Paddington  
 Mandataire: Nestec S.A., 1800 Vevey

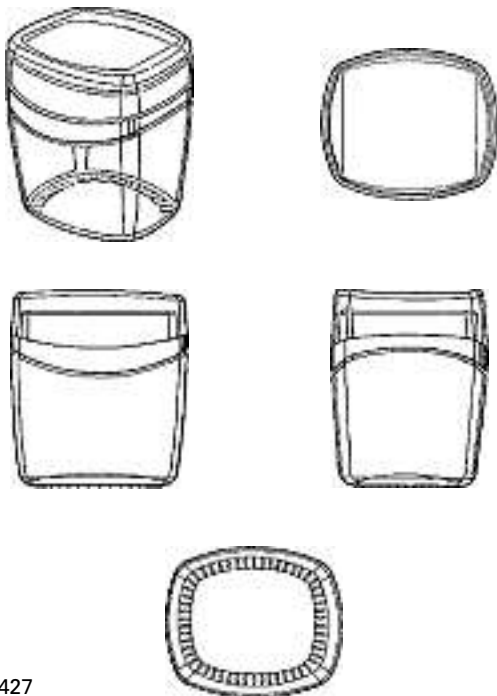

FL 63427

Cl. 07-01 133 437 29.11.2006  
 1 design – bocal  
 Déposant: Société des Produits Nestlé SA, 1800 Vevey  
 Designer: David Francis, Paddington  
 Mandataire: Nestec S.A., 1800 Vevey

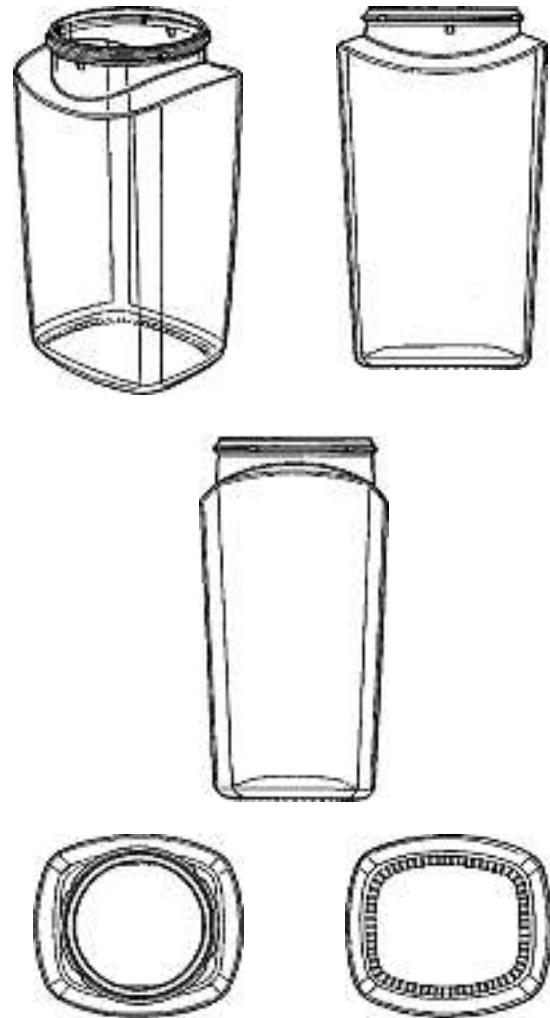

FL 63429

Cl. 07-01 133 438 29.11.2006  
 1 design – couvercle  
 Déposant: Société des Produits Nestlé SA, 1800 Vevey  
 Designer: David Francis, Paddington  
 Mandataire: Nestec S.A., 1800 Vevey

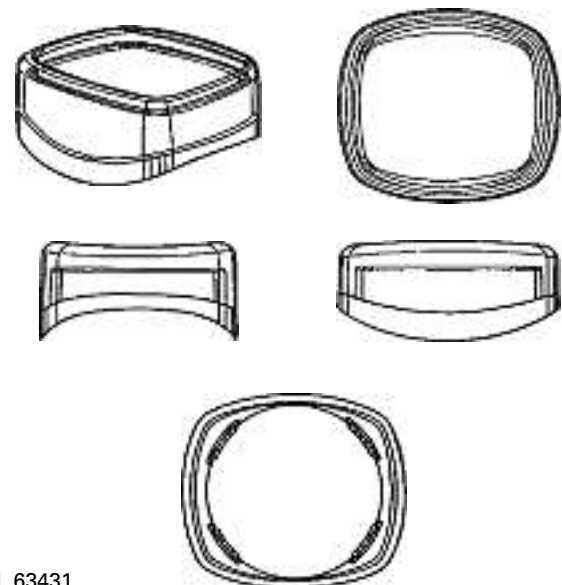

FL 63431

Cl. 07-01 133 439 29.11.2006  
 1 design – couvercle  
 Déposant: Société des Produits Nestlé SA, 1800 Vevey  
 Designer: David Francis, Paddington  
 Mandataire: Nestec S.A., 1800 Vevey

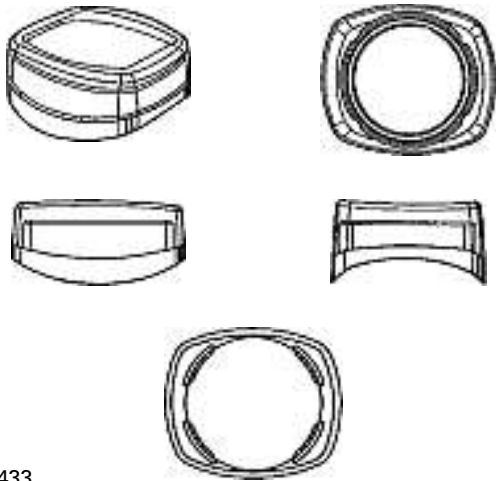

FL 63433

Cl. 09-01 133 441 20.11.2006  
 1 design – bouteille  
 Déposant: Nestlé Waters, 20, Rue Rouget de Lisle,  
 92130 Issy-les-Moulineaux, FR  
 Designer: Marc Laupie, Nomexy  
 Mandataire: Nestec S.A., 1800 Vevey

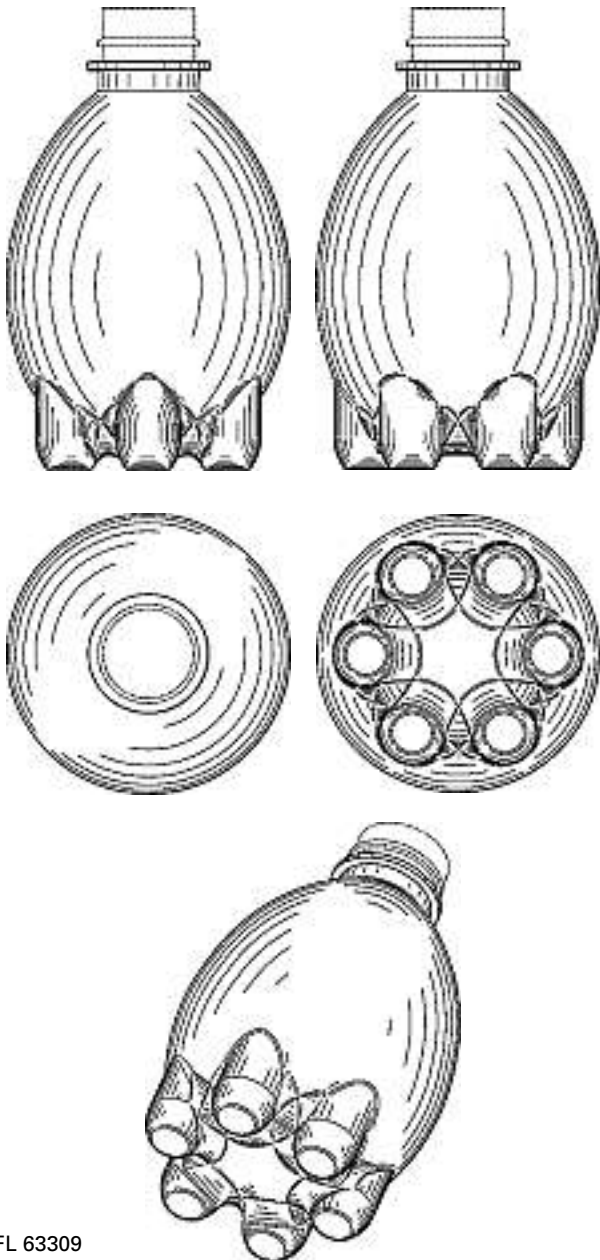

FL 63309

Cl. 09-03 133 442 17.11.2006  
 1 Design – Verpackung  
 Hinterleger: Rebgesellschaft Bielersee, Moos 3, 2513 Twann  
 Designer: Heinz Kneubühl, Biel/Bienne



Degustationspack

Cl. 10-02 133 443 13.11.2006  
 1 Design – Armbanduhr  
 Hinterleger: Glycine Watch SA, Eckweg 8, 2500 Biel/Bienne 6  
 Designer: Katherina Brechbühler Waeber, Biel



3861



Cl. 10-02 133 444 17.11.2006  
 2 design – montre et montre pendentif  
 Déposant: Montres Choisi S.A., 19, rue du Faucon, Case postale, 2500 Bienne 4  
 Designer: Jean-Pierre Duss, Bienne



29



30



Cl. 10-02 133 445 20.11.2006

4 design – montres  
 Déposant: Montres Chouriet SA, Place de la Fusterie 7, 1204 Genève  
 Designer: Binqiang Lu, Shenzhen



06.3882.L.RD





06.3881.L.WD



50.1138.G



08.1138.G

Cl. 10-07 133 446 03.11.2006  
1 design – boîte de montre  
Déposant: Vincent Plomb, Rue du Stade 1, 2926 Boncourt

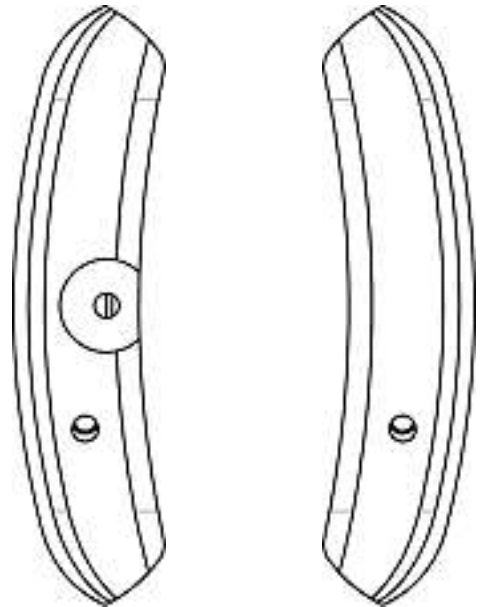
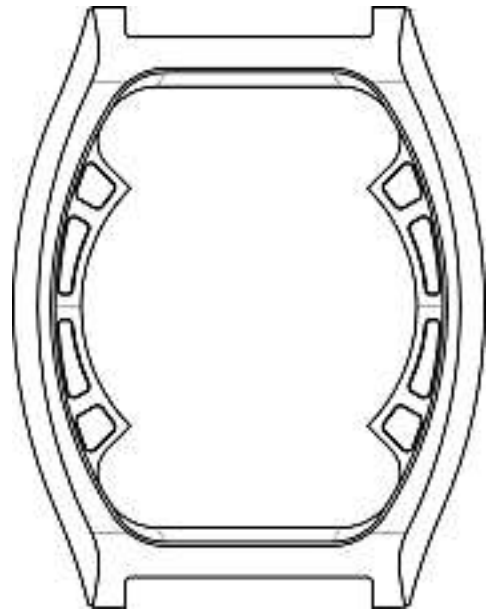

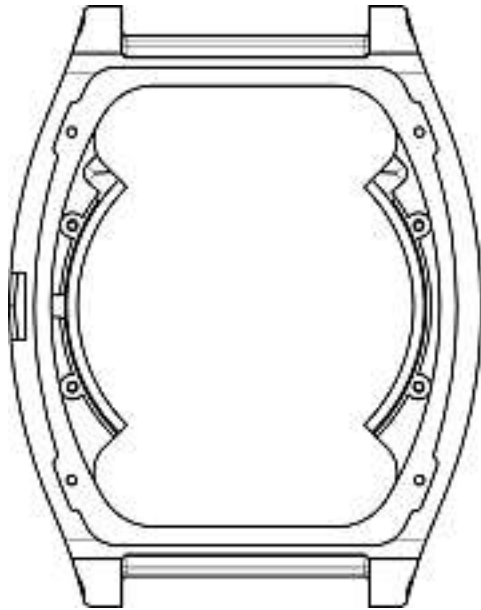

15-4



CAR-159.748.001.000

Cl. 11-01                      **133 447**                      17.11.2006  
 1 design – bijoux  
 Déposant: Cartier Création Studio SA, Boulevard James-Fazy 8,  
 1201 Genève  
 Designer: Théodora Hardy, Paris  
 Mandataire: Richemont International SA, 1293 Bellevue  
 Priorité: EM, 31.05.2006



CAR-159.747.005.000

Cl. 11-01                      **133 449**                      18.11.2006  
 1 Design – Ring  
 Hinterleger: Corinne Jeisy Järmann, Röschibachstrasse 54,  
 8037 Zürich



Cl. 11-01                      **133 448**                      17.11.2006  
 1 design – bijoux  
 Déposant: Cartier Création Studio SA, Boulevard James-Fazy 8,  
 1201 Genève  
 Designer: Théodora Hardy, Paris  
 Mandataire: Richemont International SA, 1293 Bellevue  
 Priorité: EM, 20.06.2006



Murmelring

Cl. 11-02                      **133 450**                      20.11.2006  
 1 Design – Figürchen  
 Hinterleger: Andrea Jäger, Untere Schafscheuer 1,  
 Murrhardt, DE  
 Vertreter: Zimmerli, Wagner & Partner AG, 8001 Zürich  
 Priorität: DE, 30.05.2006



Zferg (Bud)

Cl. 11-02                      **133 451**                      21.11.2006  
 2 Design – Ziergegenstand  
 Hinterleger: Karin Kiepe-Huber, Burgfelderstrasse 65,  
 4055 Basel



RHK 002



RHK 003

Cl. 11-05 133 452 31.10.2006  
 5 Design – Weihnachtsschmuck  
 Hinterleger: Ed. Jobin AG, Hauptstrasse 111, 3855 Brienz BE  
 Designer: Flavius Jobin, Brienz



1717012

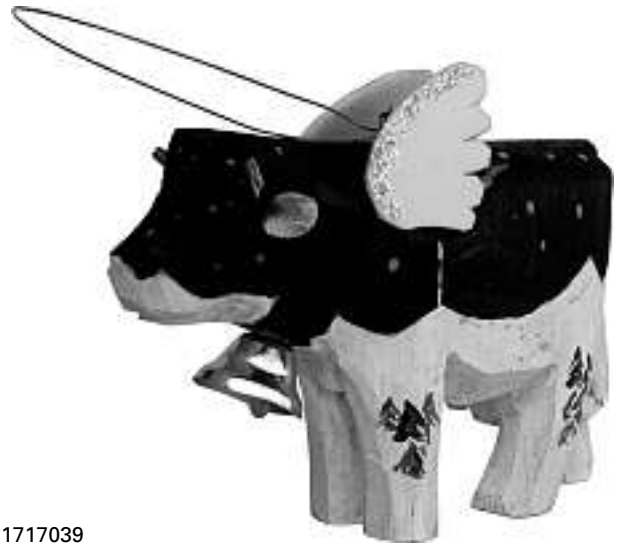

1717039



1717023



1717040



1717028

Cl. 12-11 133 453 21.09.2006  
 1 Design – Fahrradzubehör  
 Hinterleger: HAMAX AS, Makeveien 4, 1679 Krakeroy, NO  
 Designer: Janwillem Bouwknecht, Leiden  
 Vertreter: Troesch Scheidegger Werner AG, 8126 Zumikon  
 Priorität: EM, 09.05.2006

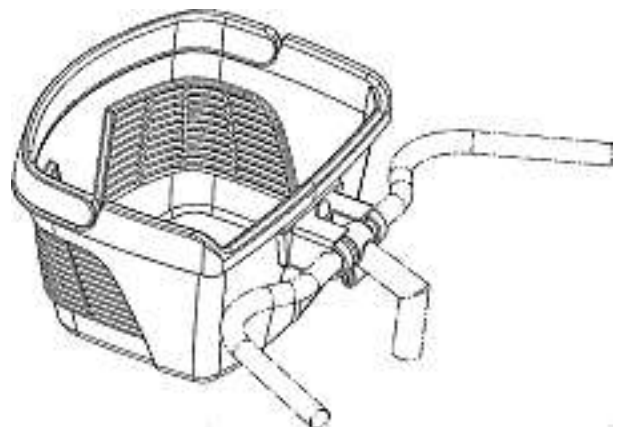

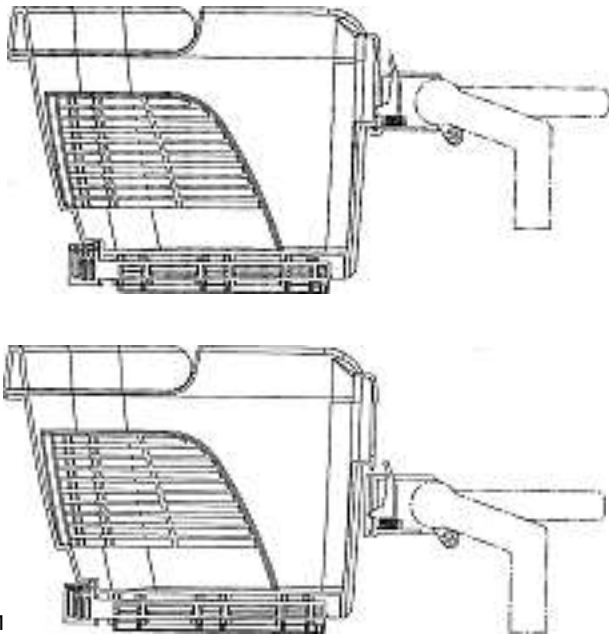

Cl. 12-14 133 454 24.11.2006

1 Design – Schlitten  
 Hinterleger: Hochschule für Technik+Architektur Luzern,  
 Technikumstrasse 21, 6048 Horw  
 Designer: Joël Bayard, Beckenried; Thomas Eglin,  
 Gretzenbach; Roman Geu, Bubikon; Frank Hochuli,  
 Wigoltingen; Yves Hug, Kindhausen; Michael Marugg,  
 Magden; Othmar Mühlebach, Kerns

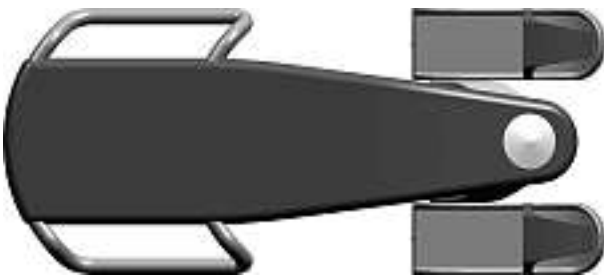

Projekt Schlitten HTA 1120171

Cl. 14-02 133 456 24.11.2006

1 Design – Tintenpatrone  
 Hinterleger: Seiko Epson Corporation, 4-1, 2-chome,  
 Nishi-Shinjuku, Shinjuku-ku, Tokyo, JP  
 Designer: Akihisa Wanibe, Nagano-ken; Taku Ishizawa,  
 Nagano-ken; Takayoshi Katsumura, Nagano-ken  
 Vertreter: Bovard AG, 3000 Bern 25  
 Priorität: JP, 31.05.2006

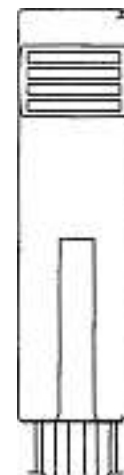
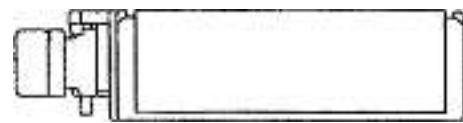
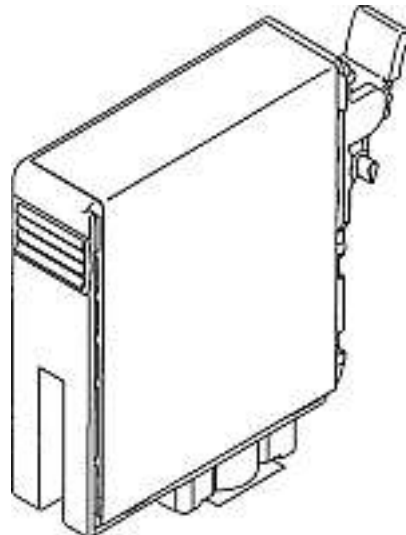
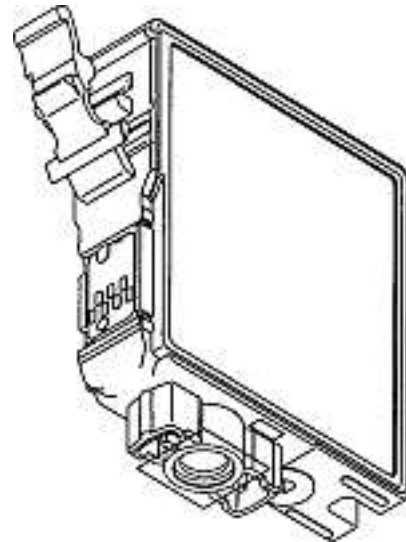

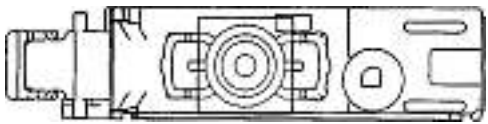
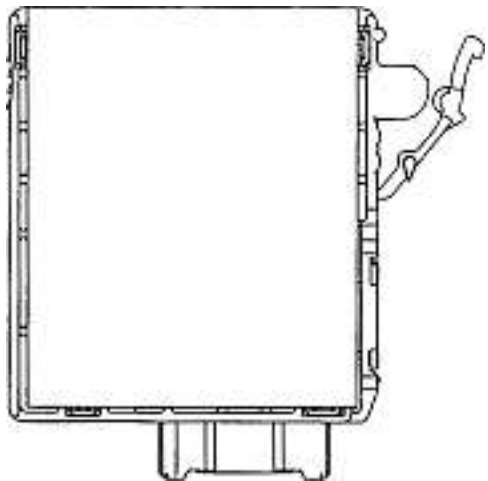
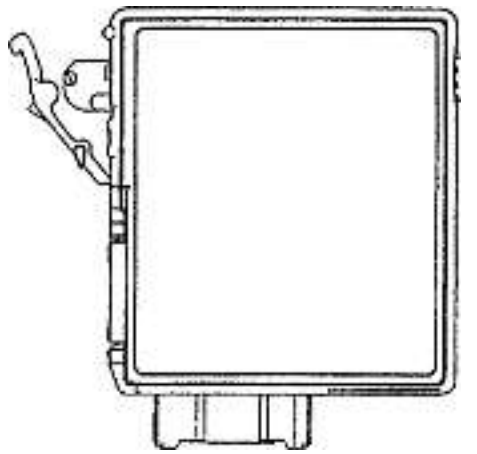

1

Cl. 14-02                      133 457                      24.11.2006  
 1 Design – Tintenpatrone  
 Hinterleger: Seiko Epson Corporation, 4-1, 2-chome,  
 Nishi-Shinjuku, Shinjuku-ku, Tokyo, JP  
 Designer: Akihisa Wanibe, Nagano-ken; Taku Ishizawa,  
 Nagano-ken; Takayoshi Katsumura, Nagano-ken  
 Vertreter: Bovard AG, 3000 Bern 25  
 Priorität: JP, 31.05.2006

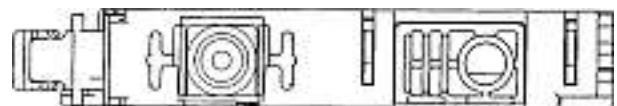
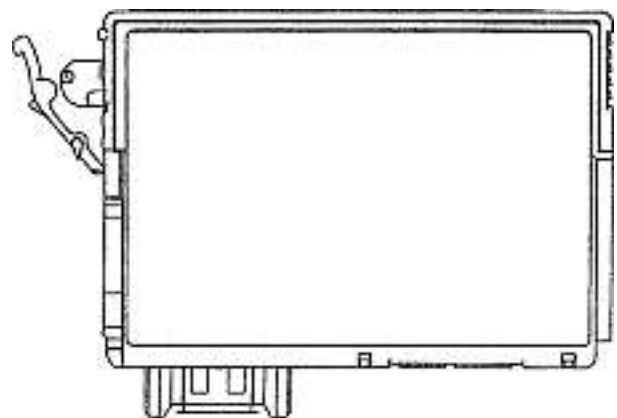
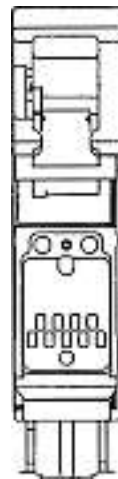
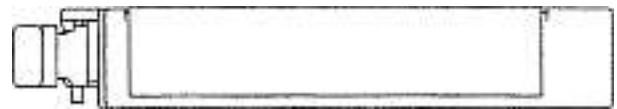
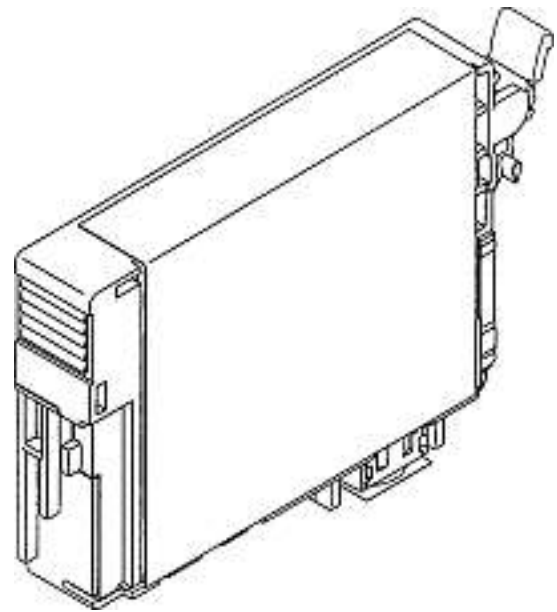
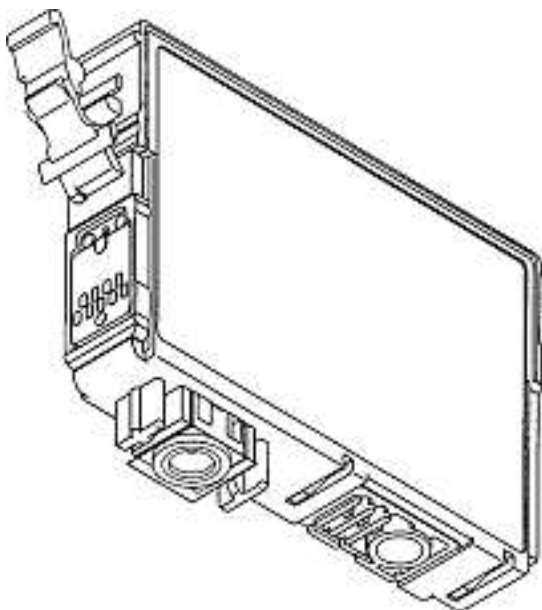

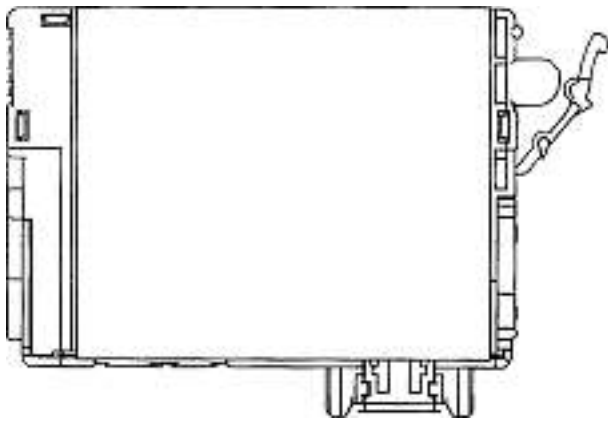

1

Cl. 14-03 133 458 07.11.2006  
 1 design – télécommande  
 Déposant: Jean-Paul Gandillon, Rue du Belvédère 4,  
 1203 Genève

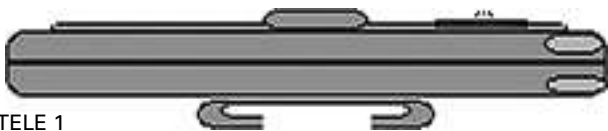
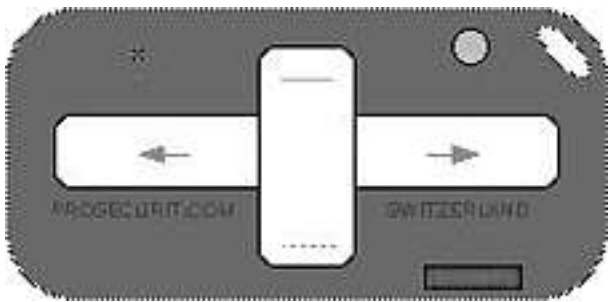
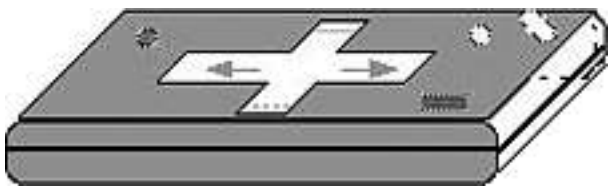

TELE 1

Cl. 16-06 133 459 30.10.2006  
 1 design – branches de lunettes  
 Déposant: Cartier Création Studio SA, Boulevard James-Fazy 8,  
 1201 Genève  
 Designer: Jean Mouclier, Paris  
 Mandataire: Richemont International SA, 1293 Bellevue  
 Priorité: EM, 05.05.2006

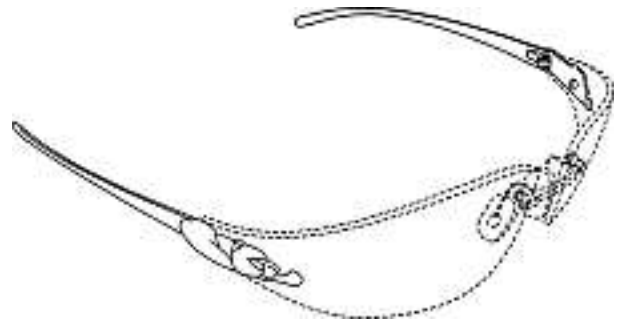

CAR-159.744.002.000



Cl. 19-08 133 460 27.11.2006  
 1 design – graphiques  
 Déposant: Alexandre Poltier, 26, ch. de Rennier, 1009 Pully

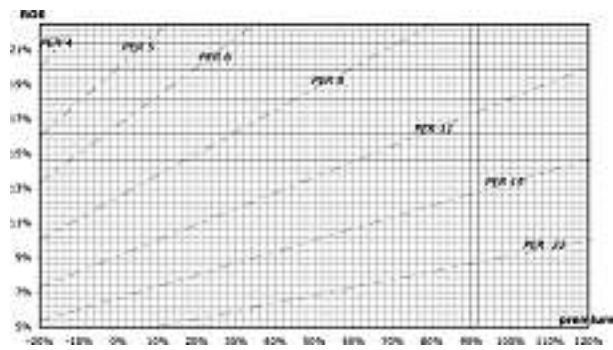

1

Cl. 20-01 133 461 21.11.2006  
 1 Design – Selbstbedienungsautomat  
 Hinterleger: Marco Martinaglia, Stadlerstrasse 47,  
 8404 Winterthur; Fachhochschule Aargau Nordwestschweiz,  
 Departement Gestaltung und Kunst, z.H. Prof. G. Naef,  
 Bahnhofstrasse 102, 5000 Aarau  
 Designer: Marco Martinaglia, Winterthur  
 Vertreter: Marco Martinaglia, 8404 Winterthur



Selecta Automat

Cl. 20-03 133 462 20.11.2006  
 3 Design – Piktogramme  
 Hinterleger: ALLRECYCLING AG, Bassersdorferstrasse 230,  
 8302 Kloten  
 Designer: Rolf Widmer, Rafz

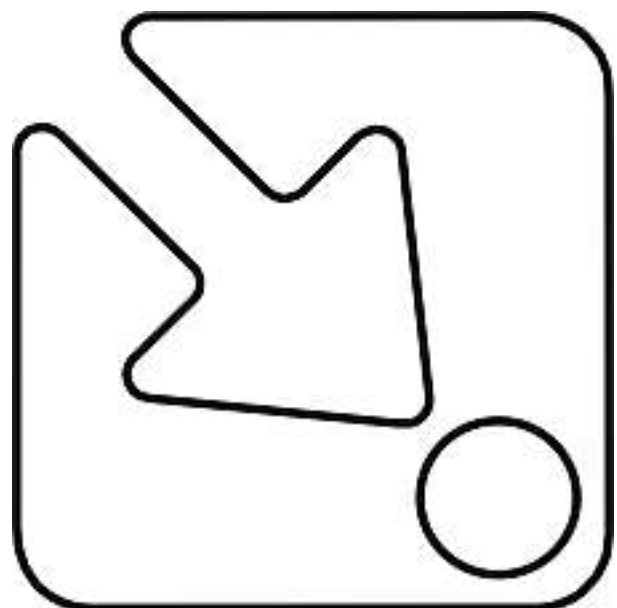

001.00

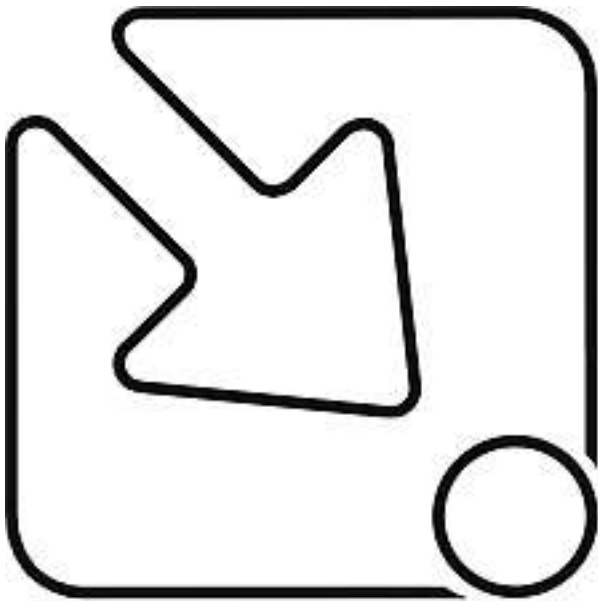

002.00

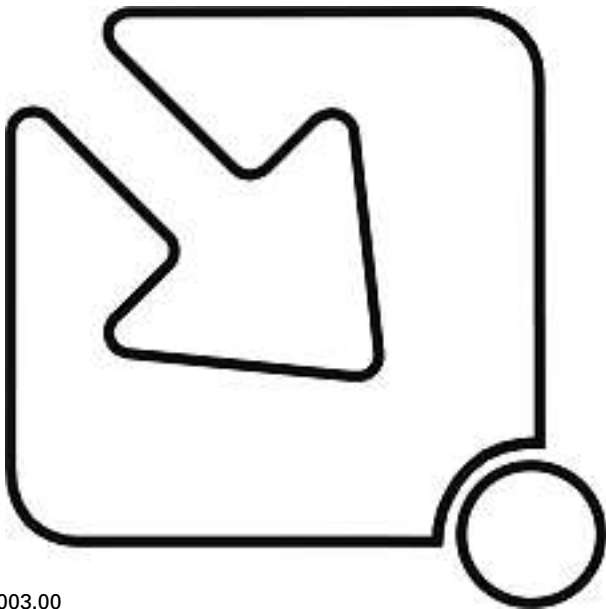

003.00

Cl. 26-06                      133 463                      07.11.2006  
 3 design – clignoteurs  
 Déposant: Jean-Paul Gandillon, Rue du Belvédère 4,  
 1203 Genève



CLIGNO 1



CLIGNO 2



CLIGNO 3

**Verlängerungen  
Prolongations  
Prolongazioni**

119 363 Cl. 09-04 1 Design

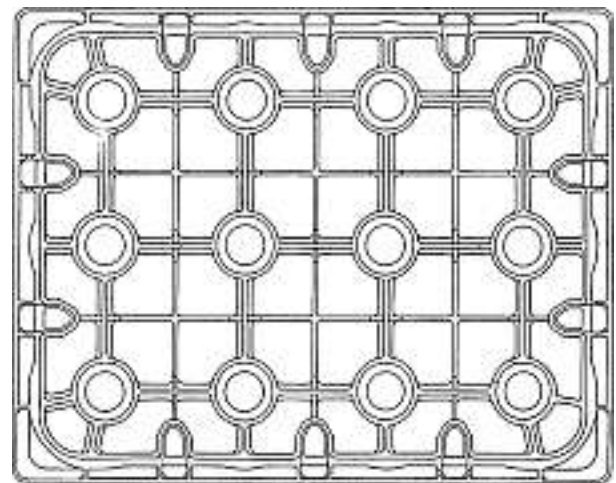
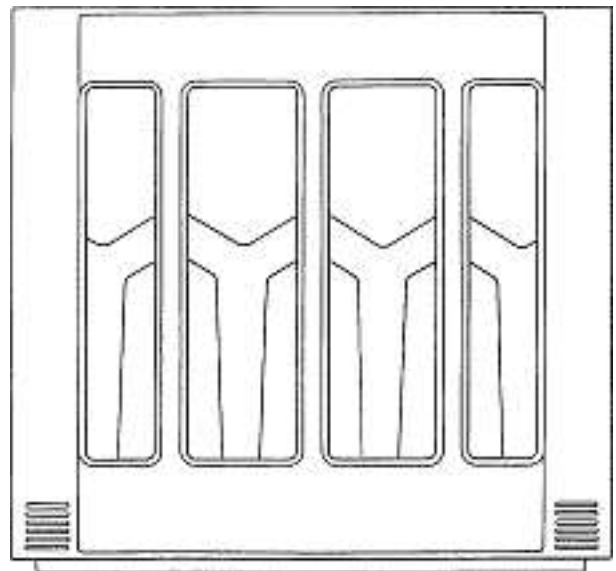
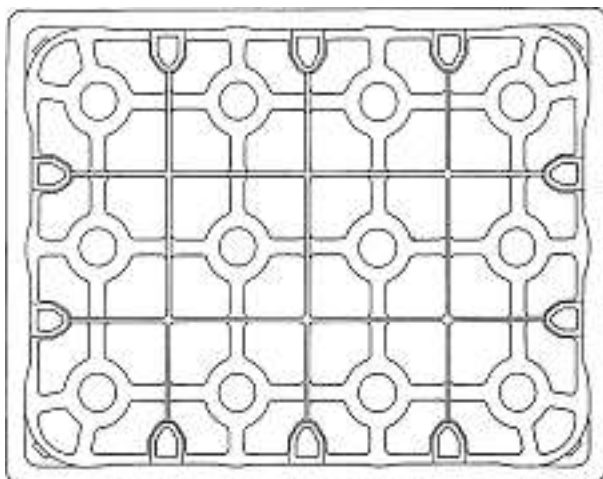
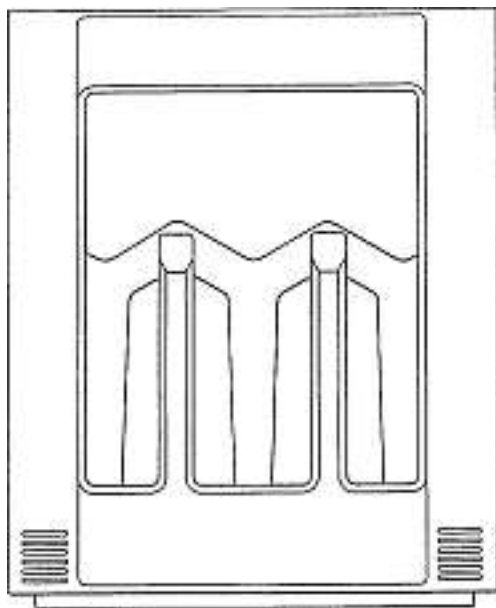
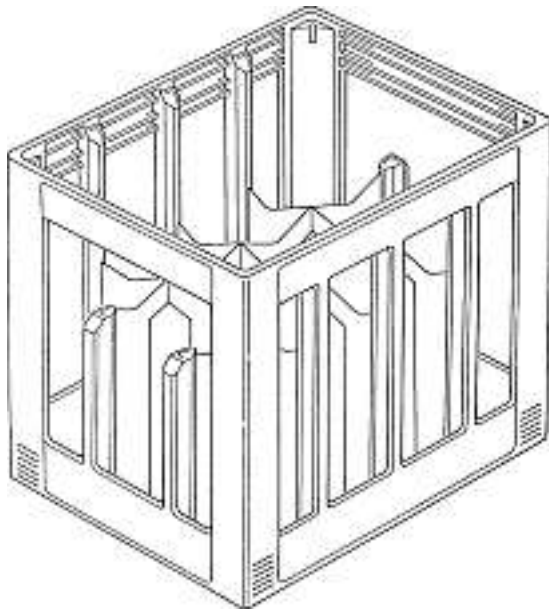

1

119 426 Cl. 24-04 2 Design

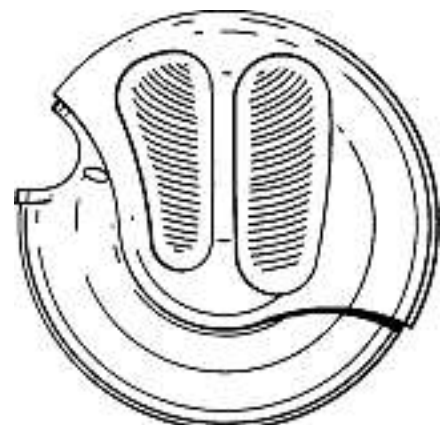
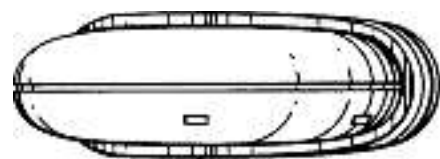

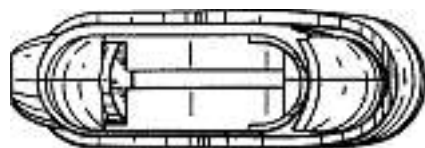
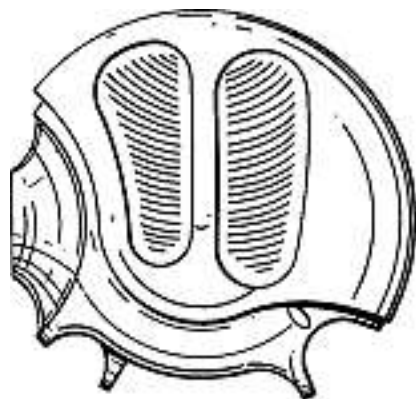
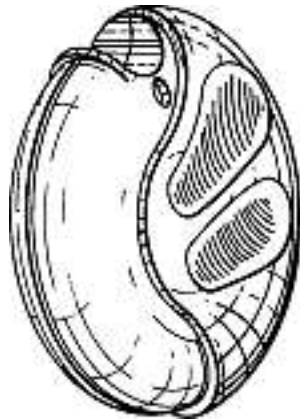
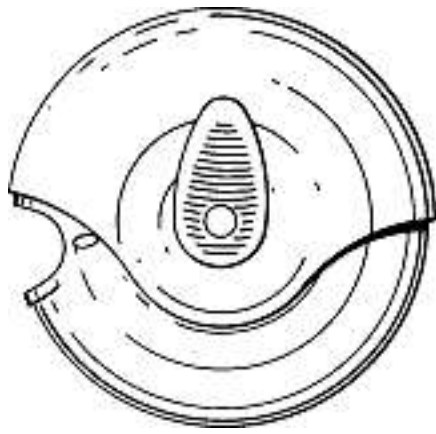

1

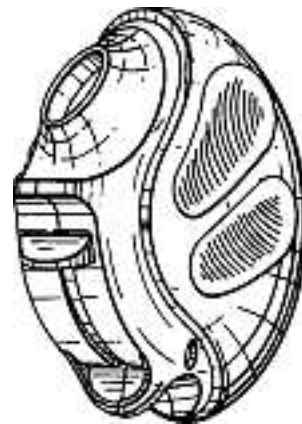
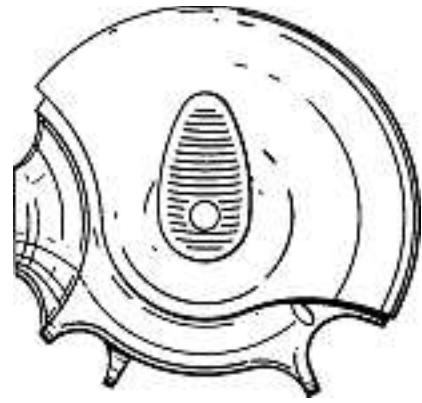

2

119 442 Cl. 09-03 1 Design

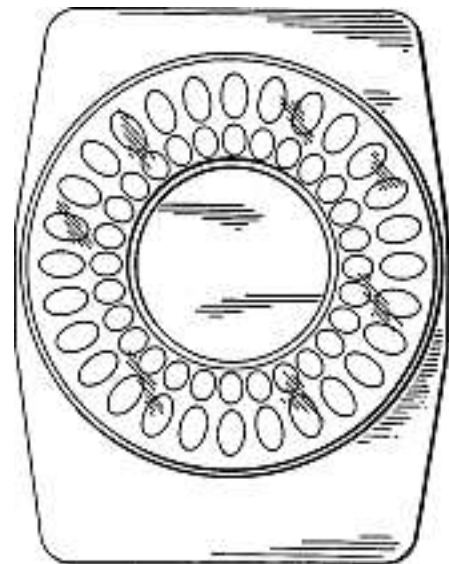

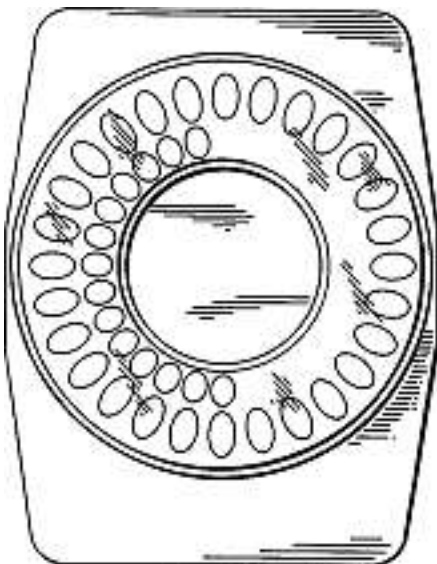
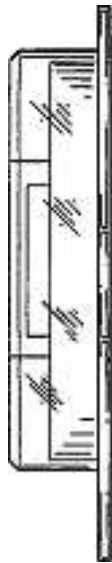
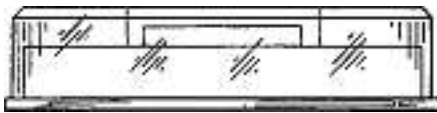

1

123 840	Cl.	09-03	1 Design
123 849	Cl.	13-03	10 design
123 860	Cl.	03-01	1 Design
123 863	Cl.	07-01	1 Design
123 907	Cl.	12-11	1 design
123 911	Cl.	12-14	1 Design
123 923	Cl.	28-03	1 Design
123 944	Cl.	20-02	1 Design
123 997	Cl.	25-03	1 Design
124 024	Cl.	01-01	124 Design
124 064	Cl.	10-07	2 design
124 067	Cl.	12-13	1 Design
124 074	Cl.	15-09	1 Design
124 090	Cl.	99-00	2 Design
124 153	Cl.	22-03	1 Design
128 447	Cl.	07-01	3 Design
128 471	Cl.	12-15	1 design
128 565	Cl.	03-99	2 Design
128 591	Cl.	11-02	26 Design
128 638	Cl.	06-01	1 Design
128 656	Cl.	10-07	3 Design
128 671	Cl.	19-08	1 Design

## Mutationen Modifications Modificazioni

116 916

117 824

Namensänderung/Namensänderung/Übertragung/  
Übertragung/Übertragung/Übertragung/Übertragung

Hinterleger: Wardle Storeys Limited, Grove Mill, Earby,  
Barnoldswick BB18 6UT, GB

Hinterleger: Mayday Survival Equipment Limited, Grove Mill,  
Earby, Barnoldswick BB18 6UT, GB

Hinterleger: Wardle Storeys Limited, Grove Mill, Earby,  
Barnoldswick BB18 6UT, GB

Hinterleger: Bernard Wardle and Company Limited,  
Grove Mill, Earby, Barnoldswick BB18 6UT, GB

Hinterleger: Wardle Storeys (Group) Limited, Grove Mill,  
Earby, Barnoldswick BB18 6UT, GB

Hinterleger: Wardle Storeys (Holdings) Limited, Grove Mill,  
Earby, Barnoldswick BB18 6UT, GB

Hinterleger: WARDLE STOREYS (EARBY) LIMITED,  
Grove Mill, Earby, Barnoldswick, BB18 6UT, GB

Vertreter: Bugnion S.A., 1211 Genève 12 - Champel

124 965

128 577

Übertragung

Hinterleger: Prevent AG, Eichbergerstrasse 60,  
9452 Hinterforst

Vertreter: Philip Schneider, Rechtsanwalt, 9001 St. Gallen

126 618

Übertragung

Hinterleger: Curlin Medical Inc., Seneca Street & Jamison  
Road, East Aurora, New York 14052, US

Vertreter: E. Blum & Co. AG, Patent- und Markenanwälte  
VSP, 8044 Zürich

127 862

Übertragung

Hinterleger: Schönegger Käse-Alm GmbH, Steinwies 20,  
Prem, DE

Vertreter: Imbofin GmbH, 6390 Engelberg

132 565

Übertragung

Hinterleger: Stuart A. Glückstein, Atelier, route de  
Reuchenette 24, 2502 Biel/Bienne

**Löschungen**  
**Radiations**  
**Radiazioni**

119 021	Cl.	14-02	1 Design
119 022	Cl.	14-02	1 Design
119 030	Cl.	22-05	22 design
119 118	Cl.	14-03	2 Design
119 162	Cl.	07-02	1 Design
123 346	Cl.	09-01	1 Design
123 348	Cl.	10-02	4 design
123 351	Cl.	11-02	1 design
123 364	Cl.	20-01	1 Design
123 368	Cl.	24-02	1 Design
123 370	Cl.	25-02	1 Design
123 435	Cl.	08-06	1 Design
128 007	Cl.	06-01	3 Design
128 008	Cl.	06-01	1 Design
128 009	Cl.	06-01	2 Design
128 019	Cl.	10-04	3 Design
128 028	Cl.	12-16	3 Design
128 031	Cl.	19-01	1 Design
128 037	Cl.	26-05	1 design
128 044	Cl.	06-01	1 Design
128 045	Cl.	06-01	8 Design
128 046	Cl.	06-01	1 Design
128 047	Cl.	06-01	1 Design
128 051	Cl.	08-06	1 design
128 054	Cl.	10-01	1 design
128 055	Cl.	10-02	2 design
128 056	Cl.	10-02	1 design
128 058	Cl.	12-06	1 Design
128 059	Cl.	12-14	1 Design
128 124	Cl.	11-02	1 Design

**Berichtigungen**  
**Rectifications**  
**Rettifiche**

**130 900**  
 Rettificazione dell'indirizzo del depositante:  
 Travessera de Gràcia 9