

## Nationale Hinterlegungen

In der folgenden Liste werden die beim Eidgenössischen Institut für Geistiges Eigentum hinterlegten Designs publiziert. Dabei sind der Reihe nach angegeben:

- internationale Klassenangaben
- Hinterlegungsnummer
- Hinterlegungsdatum
- Allenfalls Aufschub der Veröffentlichung
- Anzahl der hinterlegten Designs
- Bezeichnung
- Name und Wohnsitz des Hinterlegers oder der Hinterlegerin
- gegebenenfalls Name und Wohnsitz des Designers oder der Designerin
- Name und Geschäftssitz des allfälligen Vertreters oder der Vertreterin
- gegebenenfalls Prioritätsangaben
- gegebenenfalls Beschreibungstext
- Ordnungsnummer
- Reproduktion des Designs

## Internationale Hinterlegungen

Die bei der Weltorganisation für geistiges Eigentum in Genf hinterlegten Muster und Modelle mit Benennung Schweiz geniessen den gleichen Schutz wie national hinterlegte Designs. Sie werden jeweils im Blatt «Bulletin des dessins et modèles internationaux» veröffentlicht. Dieses Publikationsorgan ist deshalb für eine vollständige Recherche unbedingt beizuziehen.

## Topographien

Angaben über die vom Eidgenössischen Institut für Geistiges Eigentum eingetragenen Topographien von Halbleitererzeugnissen werden in folgender Anordnung aufgeführt:

- Eintragsnummer
- Anmeldedatum
- Bezeichnung
- Name und Wohnsitz des Anmelders oder der Anmelderin
- gegebenenfalls Name und Wohnsitz des Herstellers oder der Herstellerin
- Name und Geschäftssitz des oder der allfälligen Bevollmächtigten
- Datum und Ort einer allfälligen ersten geschäftlichen Verbreitung der Topographie

## Dépôts nationaux

Les designs déposés à l'Institut Fédéral de la Propriété Intellectuelle sont publiés dans la liste qui suit. Les indications y relatives sont mentionnées dans cet ordre:

- indications des classes internationales
- numéro de dépôt
- date de dépôt
- le cas échéant, ajournement de la publication
- nombre des designs déposés
- désignation
- nom et domicile du/de la déposant/e
- le cas échéant, nom et domicile du/de la designer
- nom et domicile de l'éventuel/le mandataire
- le cas échéant, indication de priorité
- le cas échéant, description du design
- numéro attribué à chaque design
- reproduction du design

## Dépôts internationaux

Les dessins et modèles déposés à l'Organisation Mondiale de la Propriété Intellectuelle à Genève qui désignent la Suisse jouissent de la même protection que les dépôts nationaux. Ils sont chaque fois publiés dans la feuille «Bulletin des dessins et modèles internationaux». Pour une recherche complète, il est indispensable de consulter ledit organe de publication.

## Topographies

Les indications concernant les topographies des produits semi-conducteurs, enregistrées par l'Institut Fédéral de la Propriété Intellectuelle, sont énumérées dans l'ordre suivant:

- numéro d'enregistrement
- date de dépôt
- désignation
- nom et domicile du/de la déposant/e
- le cas échéant, nom et domicile du/de la producteur/trice
- nom et domicile de l'éventuel/le mandataire
- date et lieu d'une éventuelle première mise en circulation de la topographie

## Depositi nazionali

Nella lista seguente vengono pubblicati i design depositati presso l'Istituto Federale della Proprietà Intellettuale. Sono menzionati nel seguente ordine:

- indicazioni delle classi internazionali
- numero di deposito
- data del deposito
- se del caso, indicazione che la pubblicazione è stata differita
- numero dei design depositati
- designazione
- nome e domicilio del depositante
- se del caso, nome e domicilio del designer
- nome e sede di un eventuale mandataro
- se del caso, indicazioni di priorità
- se del caso, descrizione del design
- numero d'ordine
- riproduzione del design

## Depositi internazionali

I disegni e modelli depositati presso l'Organizzazione Mondiale della Proprietà Intellettuale a Ginevra con denominazione Svizzera godono della medesima protezione del deposito nazionale. Essi vengono pubblicati ogni volta nel foglio «Bulletin des dessins et modèles internationaux». Quest'organo di pubblicazione è da consultare se si vuole effettuare una ricerca completa.

## Topografie

Le indicazioni concernenti le topografie di prodotti a semiconduttori depositati presso l'Istituto Federale della Proprietà Intellettuale sono menzionate nell'ordine seguente:

- numero di registrazione
- data del deposito
- designazione
- nome e domicilio del/la richiedente
- se del caso, nome e domicilio del/la produttore/trice
- nome e sede di un eventuale mandataro
- data e luogo di un'eventuale prima messa in circolazione della topografia

**Hinterlegungen  
Dépôts  
Deposit**

Cl. 10-04 130 826 18.06.2004  
 1 Design – Thermometer  
 Hinterleger: Artsana S.p.A., Via Saldarini Catelli, 1,  
 Grandate CO, IT  
 Vertreter: R. A. Egli & Co., Patentanwälte, 8008 Zürich  
 Ende aufgeschobene Publikation



D 4270



Cl. 23-02 131 348 24.12.2004  
 1 design – poignée de douche  
 Déposant: Similor Kugler SA, 16bis, rue Joseph-Girard,  
 Case Postale 1656, 1227 Carouge GE  
 Designer: Alberto Morbio, Carpenedolo  
 Mandataire: Micheli & Cie, 1226 Thônex (Genève)  
 Fin de la période ajournement de la publication





14365A

Cl. 03-01                      **131 446**                      16.01.2005  
 1 Design – Tasche  
 Hinterleger: Roy Grosser, Weggengasse 2, 8001 Zürich  
 Ende aufgeschobene Publikation

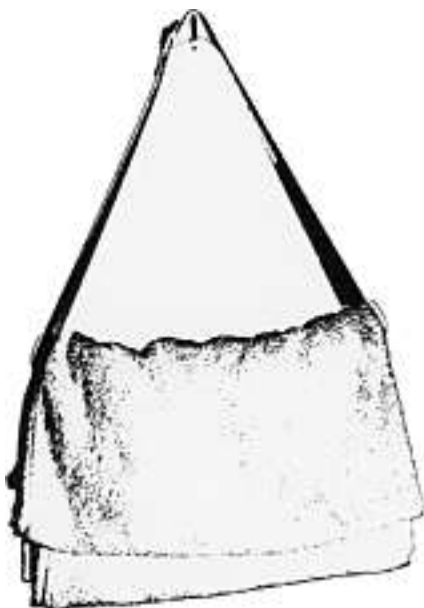
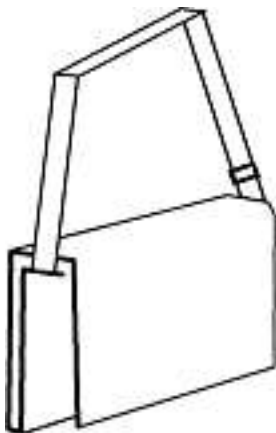

1

Cl. 23-02                      **132 263**                      10.11.2005  
 1 design – douchette  
 Déposant: Similor Kugler SA, 16bis, rue Joseph-Girard,  
 Case Postale 1656, 1227 Carouge GE  
 Designer: Alberto Morbio, Carpenedolo  
 Mandataire: MICHELI & CIE SA, 1226 Thônex  
 Fin de la période ajournement de la publication





14589A

Cl. 23-01 132 676 26.01.2006

5 Design – Hydrant  
Hinterleger: vonRoll investment ag, Bahnhofstrasse 23,  
6300 Zug  
Designer: Antoine Cahen, Lausanne; Philippe Cahen,  
Lausanne  
Vertreter: B&P tax and legal AG, 8022 Zürich  
Ende aufgeschobene Publikation

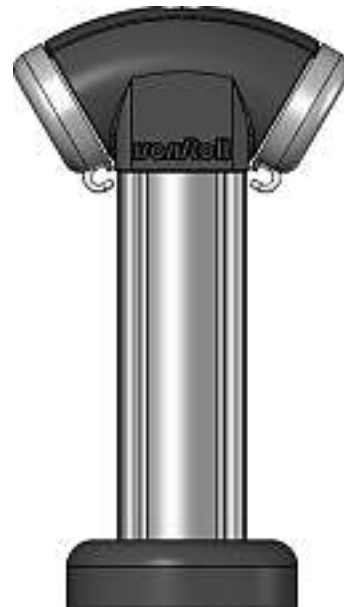



world 1



world 2

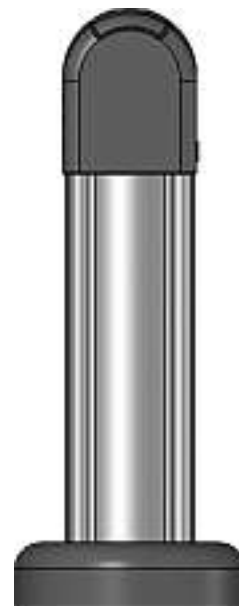
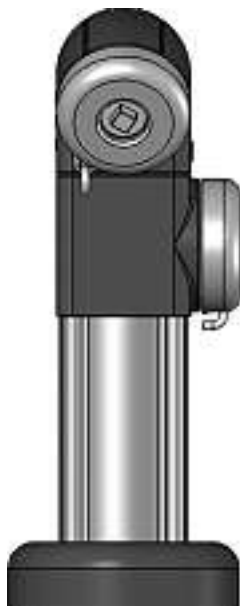
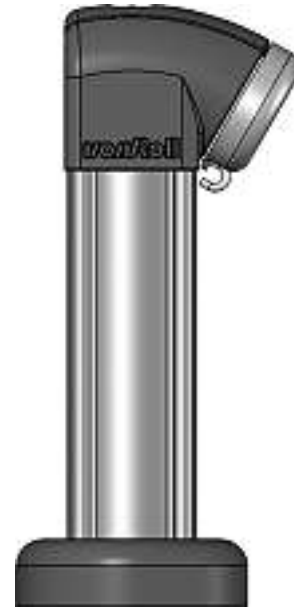



world 3

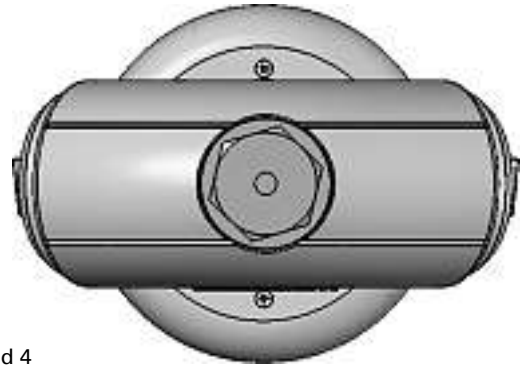

world 4

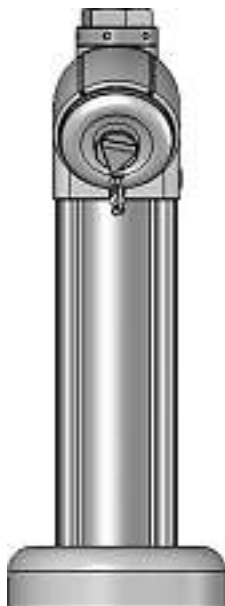



world 5

Cl. 02-01 133 227 26.09.2006  
 1 design – vêtement d'allaitement  
 Déposant: Monique Loussier, 25, rue des Essarts, Esternay, FR;  
 Béatrice Tebaldi, Place de la Libération, Puy Laroque, FR  
 Mandataire: MICHELI & CIE SA, 1226 Thônex  
 Description du design: La figure 1.1 est une vue de face en position fermée. La figure 1.2 est une vue de face en position partiellement ouverte. La figure 1.3 est une vue de face en position totalement ouverte. La figure 1.4 est une vue de l'envers de la face avant.

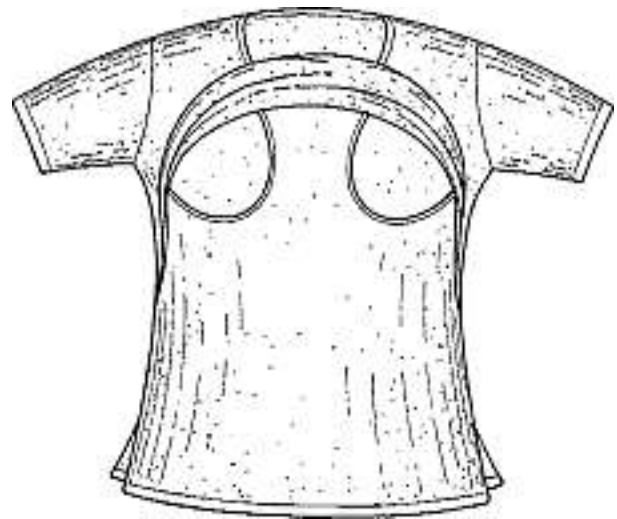
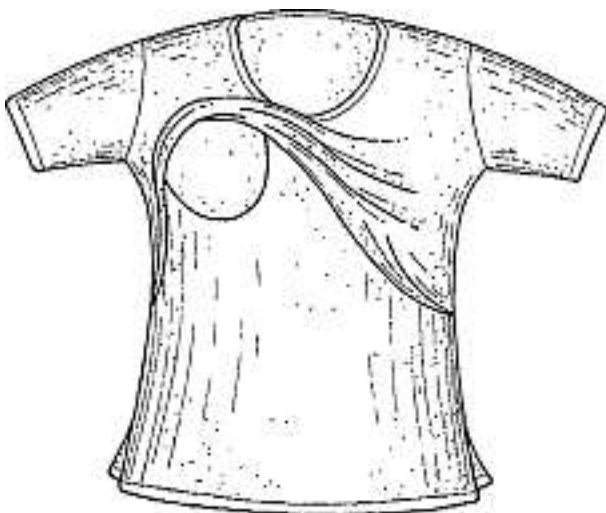

14811

Cl. 02-04, 02-07 133 228 03.10.2006  
 8 design – chaussures, décor pour chaussures, semelle de chaussures, boucles de ceinture  
 Déposant: JM WESTON, Rue Nicolas Appert, Zone Industrielle Nord, Limoges, FR  
 Designer: Jean-Christopher Descours, Limoges  
 Mandataire: Griffes Consulting S.A., 1206 Genève





00111-MO-0037-CH



00111-MO-0038-CH



00111-MO-0039-CH



00111-MO-0040-CH





00111-MO-0042-CH



00111-MO-0043-CH



00111-MO-0041-CH



00111-MO-0044-CH



Cl. 06-01, 06-03, 06-06 **133 230** 03.10.2006  
 8 design – sedie, tavolini, attaccapanni  
 Depositante: Bonaldo SpA, Via Straelle 3, Villanova di Camposampiero (Padova), IT  
 Designer: James Bronte, Villanova di Camposampiero; Karim Rashid, New York; Claudio Dondoli, Colle Val d'Elsa; Mauro Lipparini, Firenze; Mario Mazzer, Conegliano  
 Mandatario: Jacobacci & Partners S.A., 1207 Genève  
 Priorità: EM, 07.04.2006



1





2



3





4



5



6





7



8

Cl. 06-03 133 231 18.09.2006  
 1 design – table  
 Déposant: Muriel Sottas Clément, Impasse des Cerisiers 1,  
 1726 Farvagny



box\_mu.1

Cl. 06-04 133 232 25.09.2006  
 1 Design – Kastenmöbel  
 Hinterleger: Ulrich Biesenkamp, Bernstrasse 19, 3600 Thun  
 Vertreter: Kellerhals Hess, Rechtsanwälte, 3001 Bern





Uniquemodul

Cl. 06-04, 06-06 133 233 30.09.2006  
8 Design – Schrank und Teil davon  
Hinterleger: Vitra Patente AG, Klünenfeldstrasse 22,  
4132 Muttenz  
Designer: Antonio Citterio, Mailand  
Vertreter: AXON Patent GmbH, 4147 Aesch



1

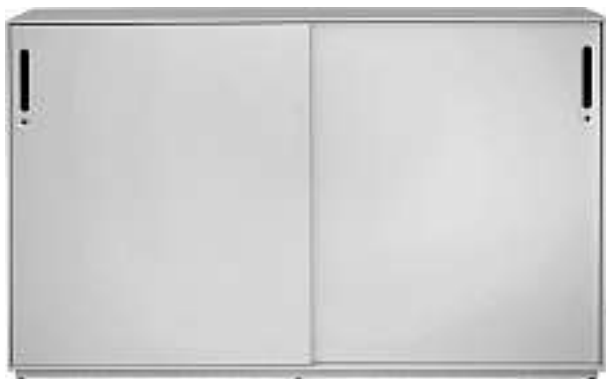

2



3



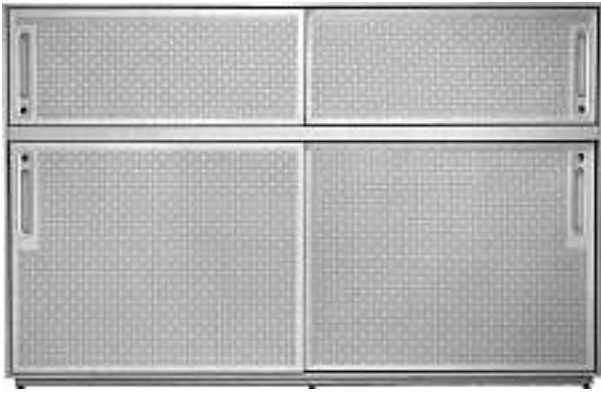

5



6

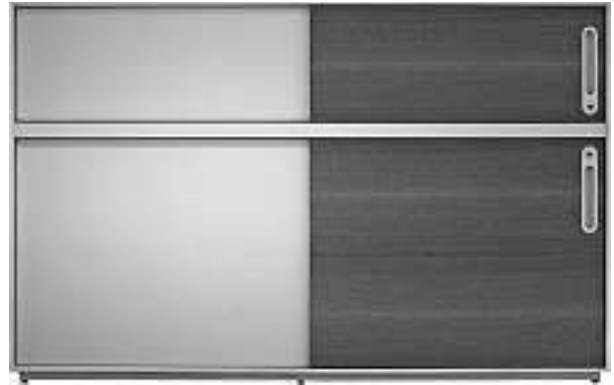

7

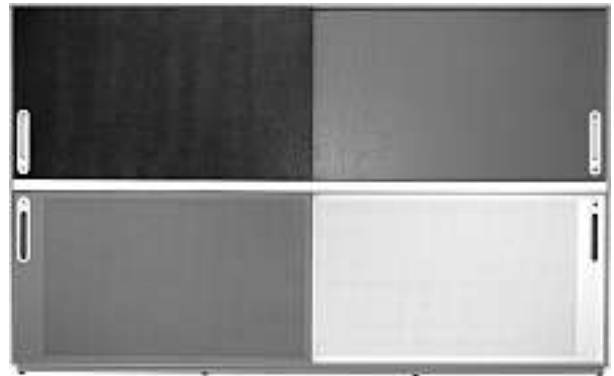

8

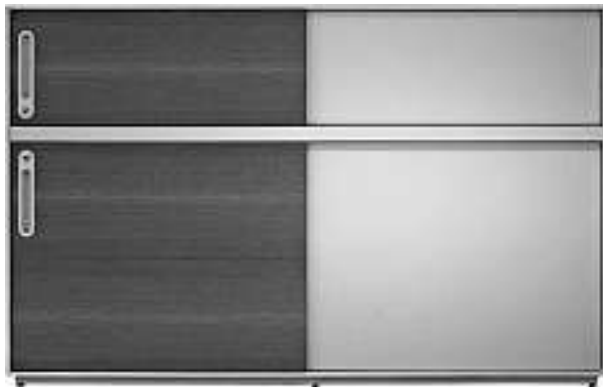
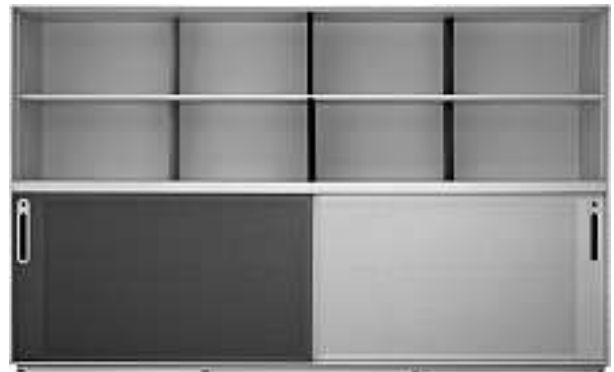

Cl. 07-01 **133 234** 04.09.2006

2 Design – Gebäckbehälter und Zubehör

Hinterleger: Bradshaw International, Inc., 9409 Buffalo Avenue, Rancho Cucamonga, CA, US

Designer: Thomas Barber, Rancho Cucamonga

Vertreter: Keller & Partner Patentanwälte AG, 3000 Bern 7

Priorität: US, 10.03.2006

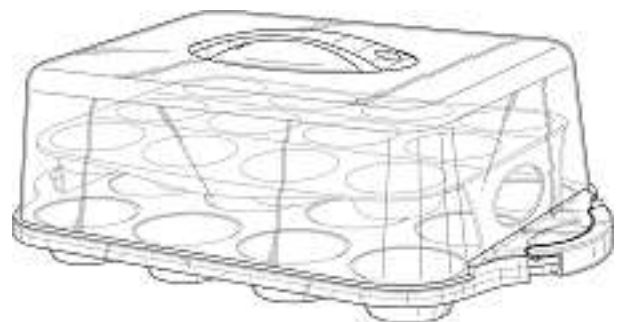



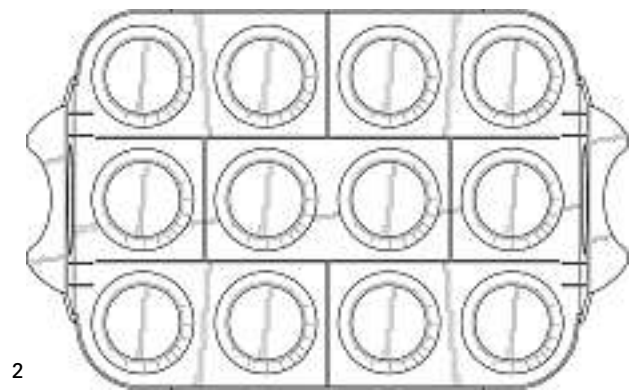
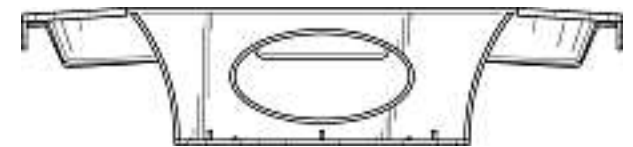
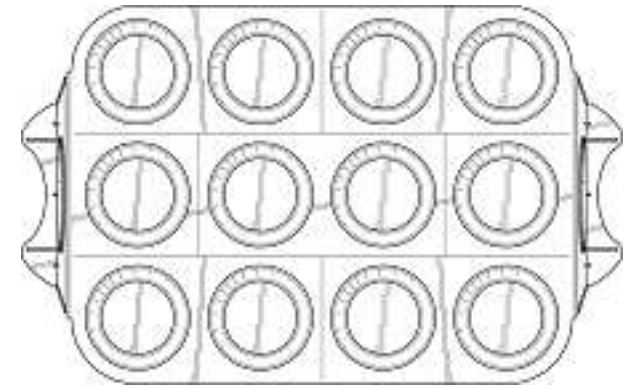
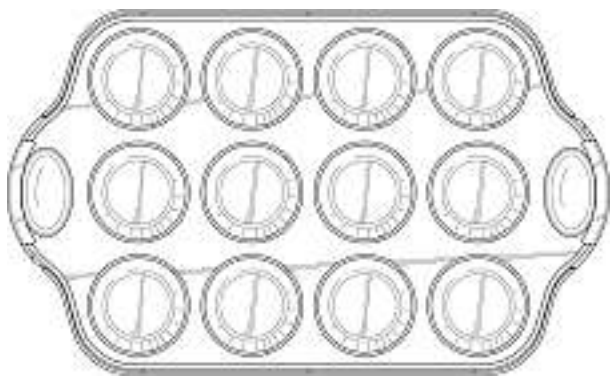
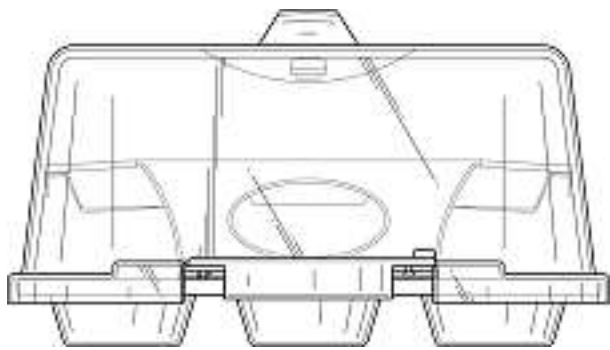
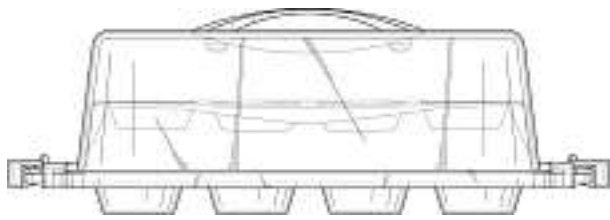
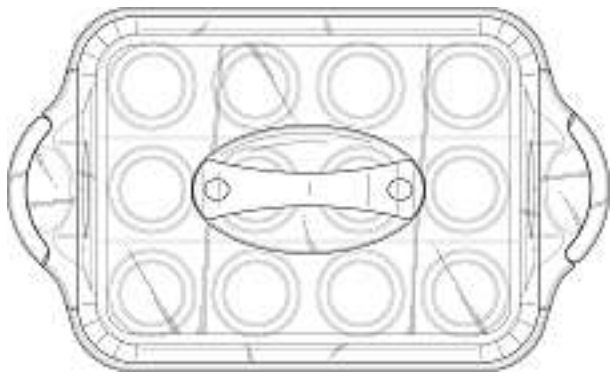

2

Cl. 07-02 133 235 02.06.2006  
2 Design – Kaffeemaschinen  
Hinterleger: SGL Italia S.r.l., Strada San Mauro, 25,  
10156 Torino, IT  
Designer: Virginio Cortese, Torino  
Vertreter: Bovard AG, 3000 Bern 25  
Priorität: EM, 02.12.2005

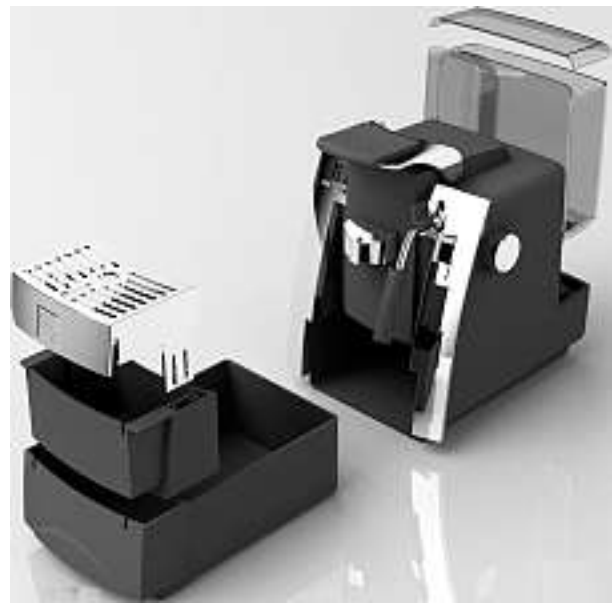



2

Cl. 07-02 133 236 29.09.2006  
 1 Design – Caquelon  
 Hinterleger: Karin Kuster, Dorfstrasse 83, 6377 Seelisberg



Ying-Yang-Caquelon

Cl. 11-01 133 242 03.10.2006  
 1 design – bague  
 Déposant: Jean-Claude Guinand & fils,  
 Alexis-Marie-Piaget 71, 2300 La Chaux-de-Fonds  
 Designer: Jean Humm, Les Brenets  
 Mandataire: Soprintel S.A., 2300 La Chaux-de-Fonds

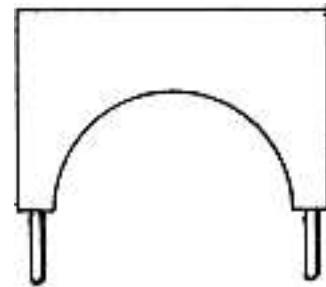
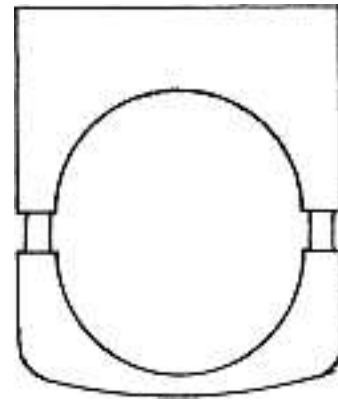

1

Cl. 11-02 133 243 22.09.2006  
 3 Design – Skulpturen  
 Hinterleger: Karl Bauer, Bergwerkstrasse 27, 5027 Herznach



01



02



03

Cl. 12-05 133 244 20.09.2006  
 1 Design – Schwimmbadlift  
 Hinterleger: Paul Hurter, Winkelbuel 3a, 6043 Adligenswil

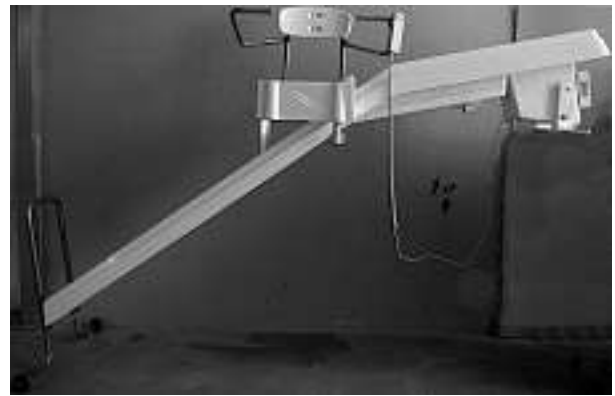

1

Cl. 12-08 133 245 05.10.2006  
 1 Design – Nutzfahrzeug  
 Hinterleger: IVECO S.P.A., Via Puglia 35, Turin, IT  
 Designer: Giovanni Capello, Cirie; Paolo Mirone, Rivalta di Torino  
 Vertreter: Schmauder & Partner AG, Patent- und Markenanwälte VSP, 8038 Zürich  
 Priorität: EM, 18.04.2006





1

Cl. 12-11 133 246 13.09.2006

1 design – motocicletta

Depositante: Honda Motor Co., Ltd., No. 1-1, 2-chome,  
Minami-aoyama, Minato-ku, Tokyo, JPDesigner: Akihiro Sawabe, Saitama-ken; Hirotsugu Ueno,  
Saitama-ken; Kiyoshi Katagiri, Saitama-ken

Mandatario: Fiammenghi-Fiammenghi, 6900 Lugano

Priorità: JP, 23.03.2006





Cl. 15-01 **133 247** 26.09.2006  
1 design – motore a combustione interna  
Depositante: Honda Motor Co., Ltd., No. 1-1, 2-chome,  
Minami-aoyama, Minato-ku, Tokyo, JP  
Designer: Masayuki Osumi, Saitama  
Mandatario: Fiammenghi-Fiammenghi, 6900 Lugano  
Priorità: JP, 30.03.2006





490



Cl. 15-09 **133 248** 26.09.2006

1 Design – Laserschneidemaschine  
 Hinterleger: Bystronic Laser AG, Industriestrasse 21,  
 3362 Niederönz  
 Designer: Karel Formanek, Solothurn  
 Vertreter: R. A. Egli & Co., Patentanwälte, 8008 Zürich

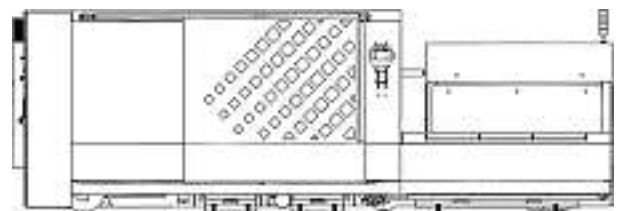

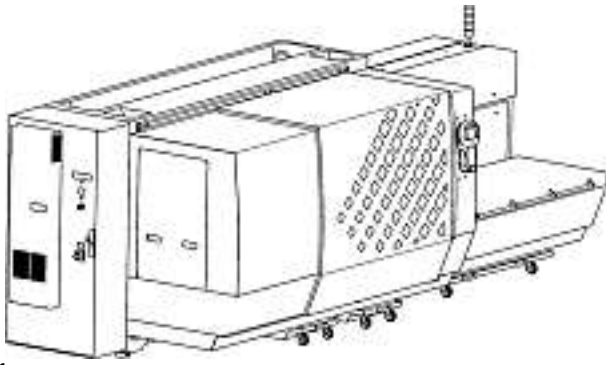

1

Cl. 16-03 133 249 25.09.2006  
1 design – cartuccia toner  
Depositante: Kyocera Mita Corporation, 2-28, 1-chome,  
Tamatsukuri, Chuo-ku, Osaka, JP  
Designer: Takashi Tamura, Osaka  
Mandatario: M. ZARDI & CO. S.A., 6900 Lugano  
Priorità: JP, 27.03.2006

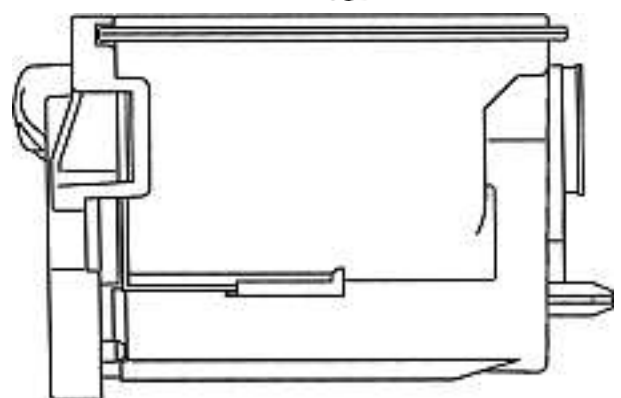
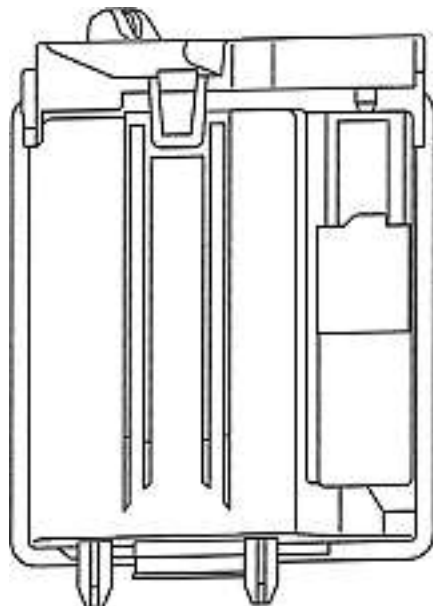
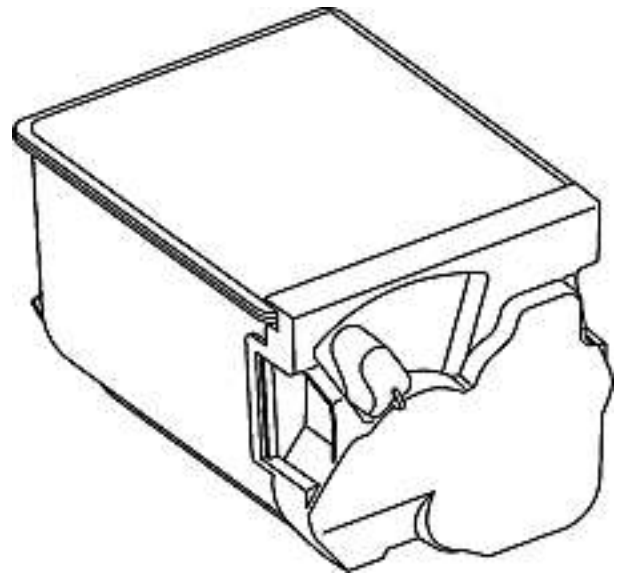
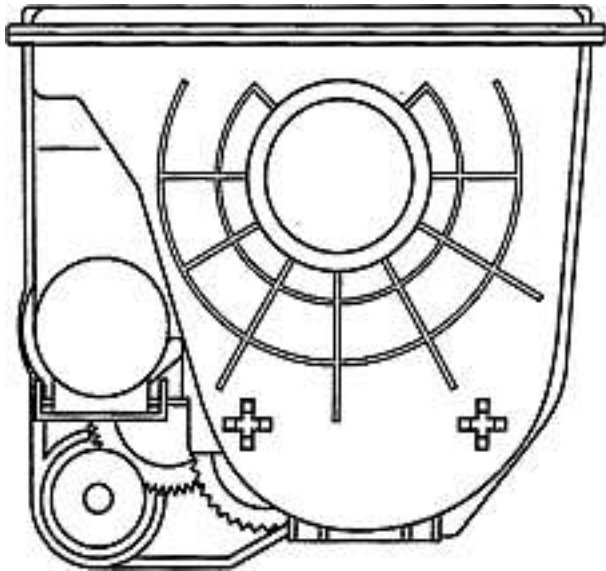
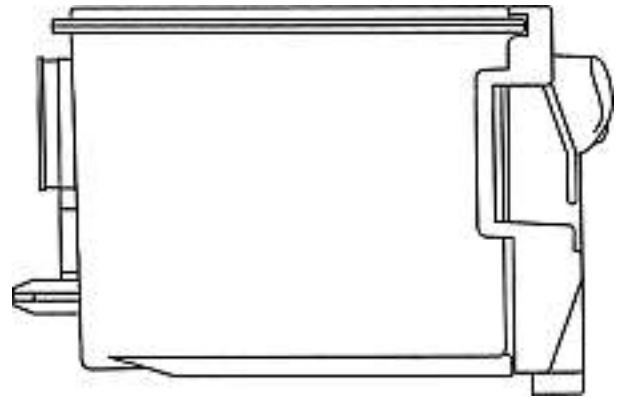
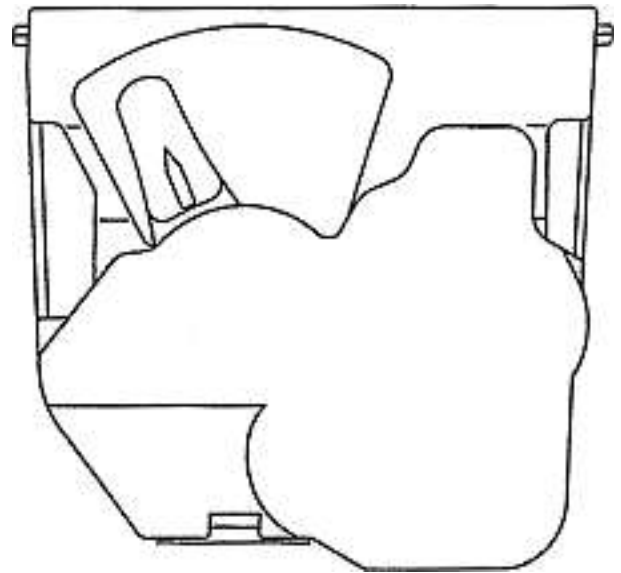



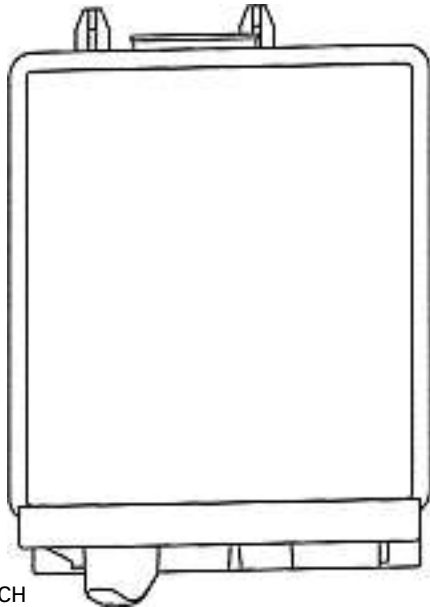
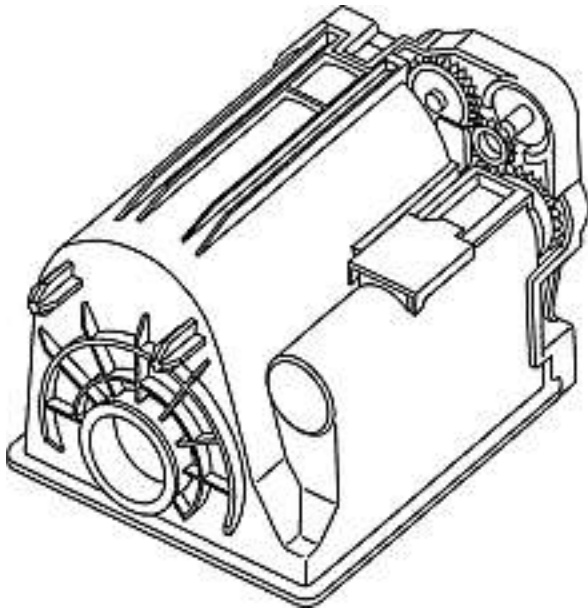

GIP008OCH

Cl. 19-08                      133 250                      21.09.2006  
 3 Design – Druckvorlagen  
 Hinterleger: Yoav Parish, Gmeimeriweg 6, 8047 Zürich



SCHOP01





SCHOP03

Cl. 19-08 133 251 25.09.2006  
2 Design – Druckvorlagen  
Hinterleger: Karin Schmid-Degen, Sackweidhöhe 14, 6012 Obernau



SCHOP02

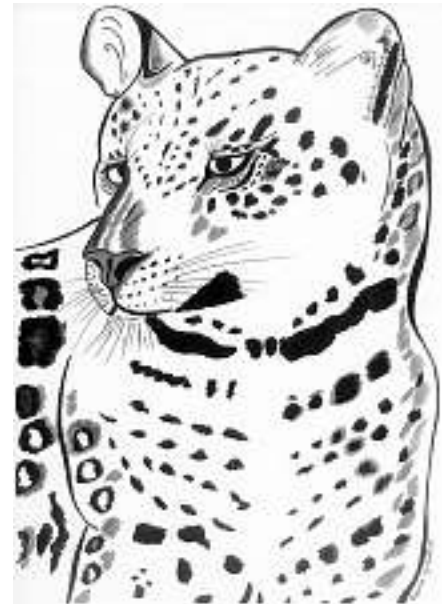

Leopard 2003  
karina

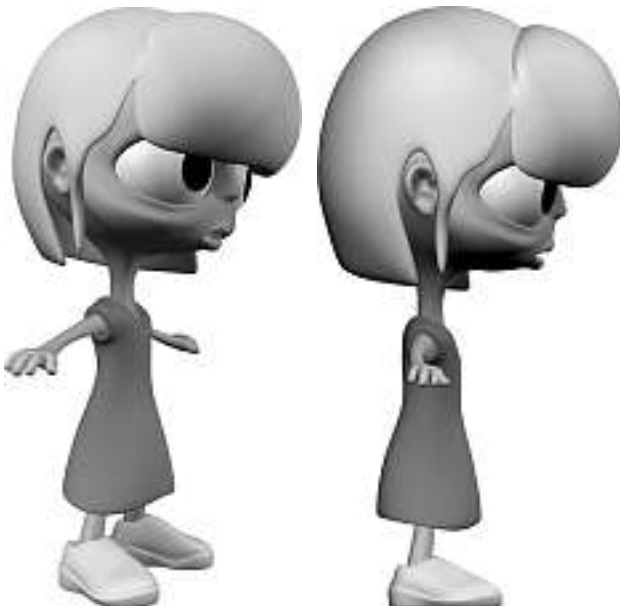

Tiger karina  
2003

Cl. 20-01 133 252 25.09.2006  
5 Design – Verkaufsautomaten  
Hinterleger: Sielaff GmbH & Co. KG Automatenbau,  
Münchener Strasse 20, 91567 Herrieden, DE  
Designer: Klaus-Diether Krause, Dietenhofen  
Vertreter: Hepp Wenger Ryffel AG, 9500 Wil SG  
Priorität: EM, 12.07.2006

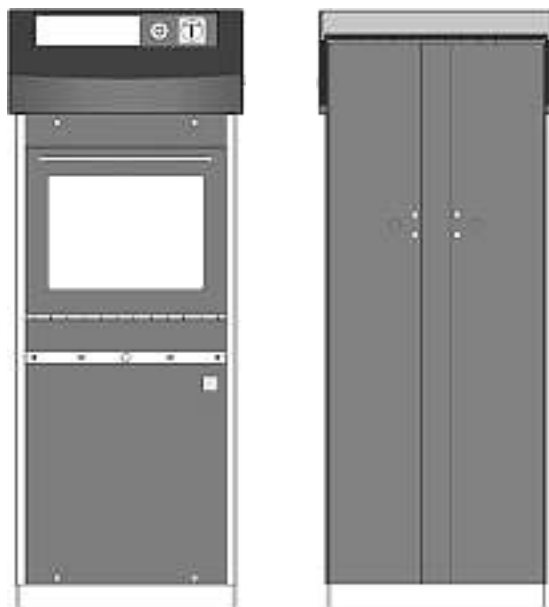
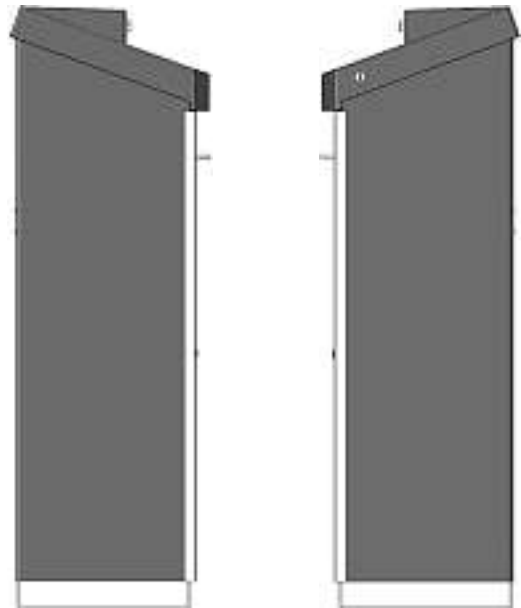
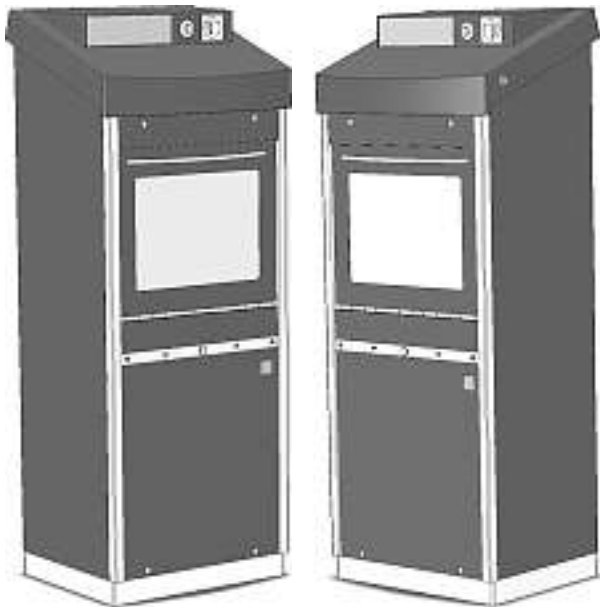

MSIE001CH1



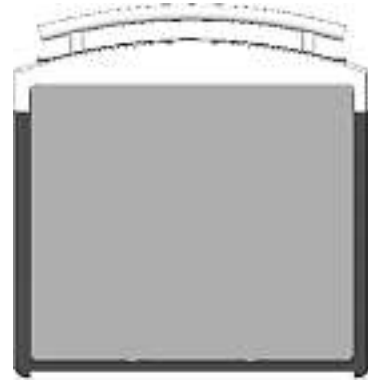
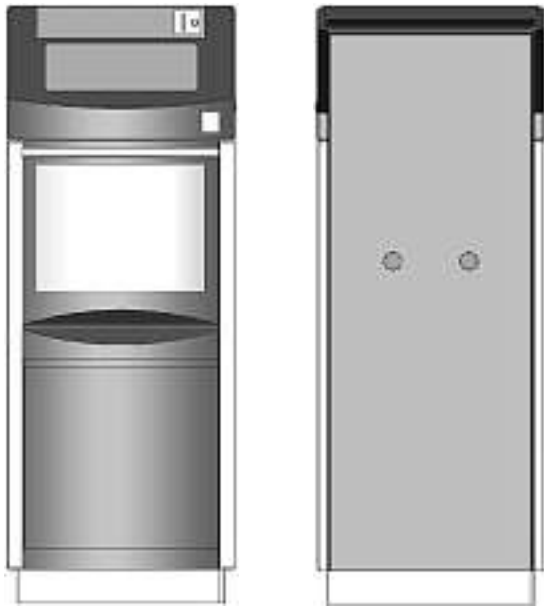

MSIE001CH2

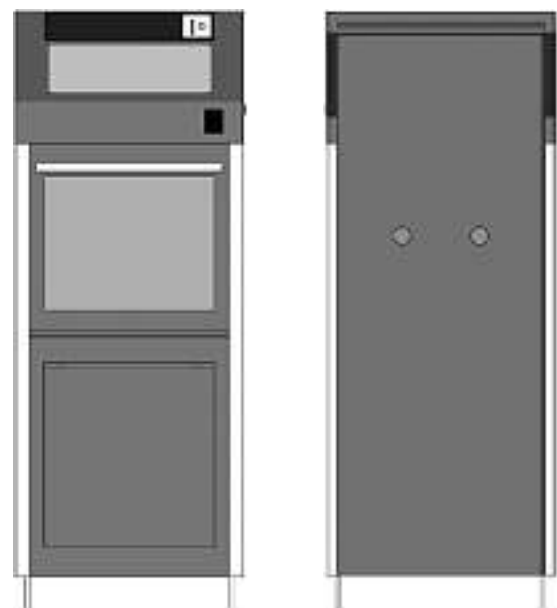
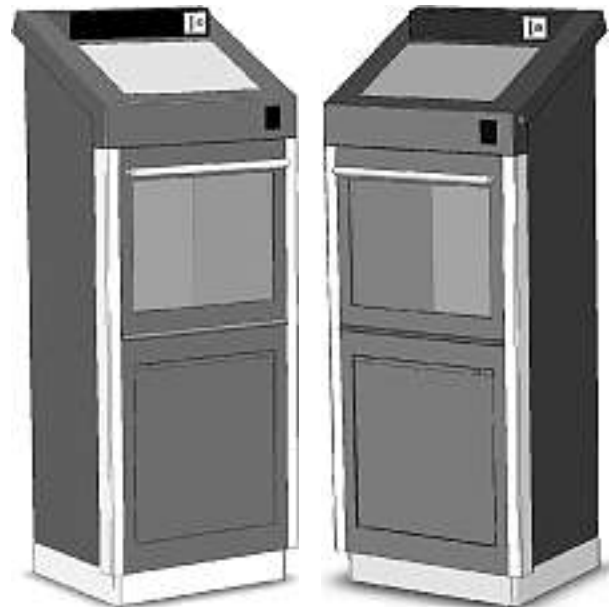
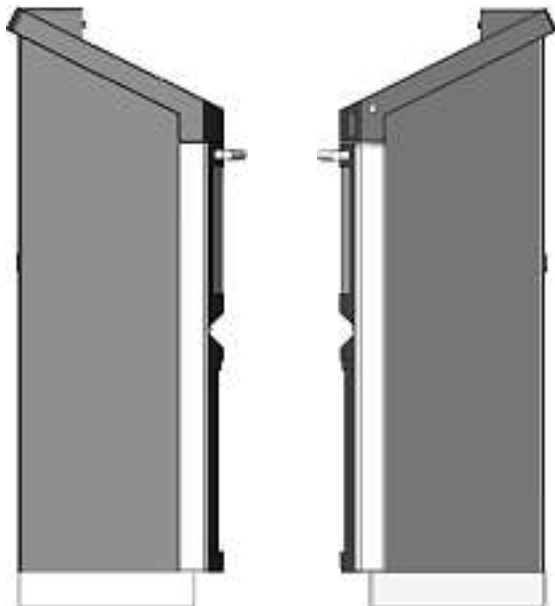

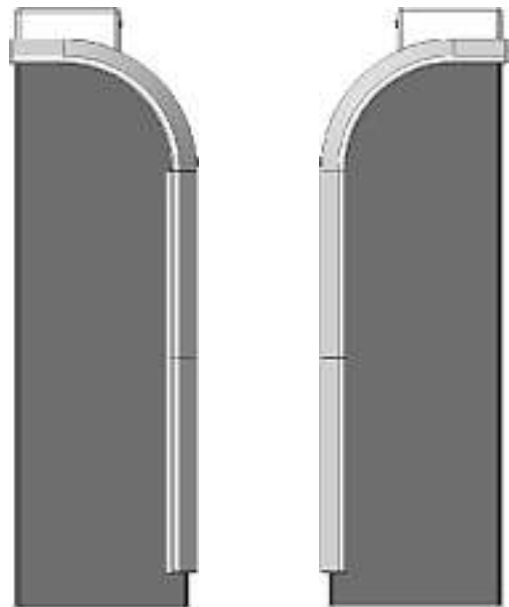
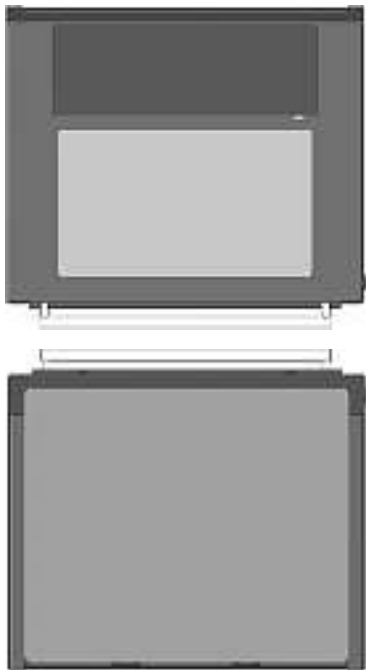
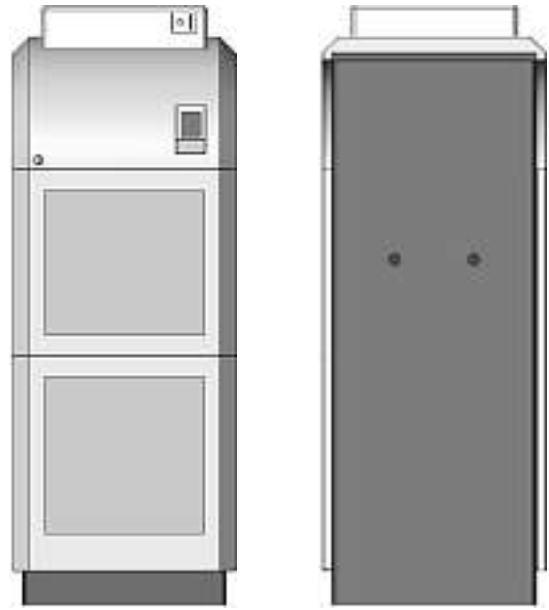
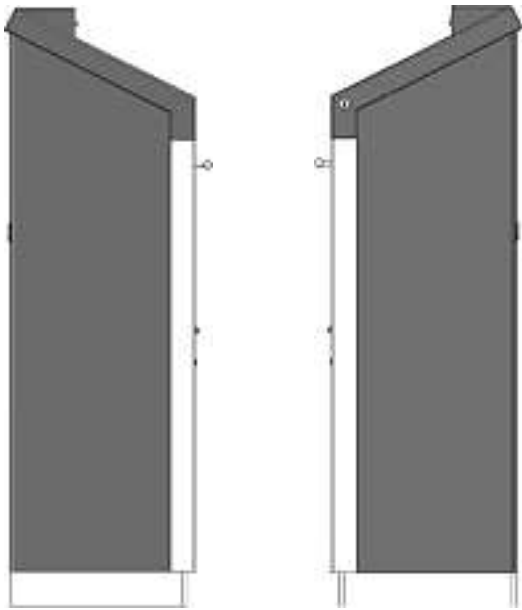

MSIE001CH3



MSIE001CH4

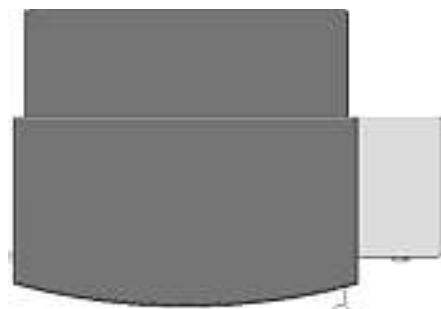
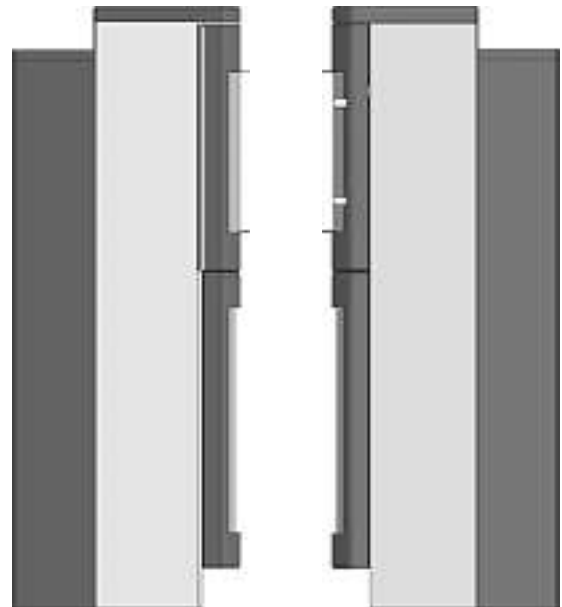
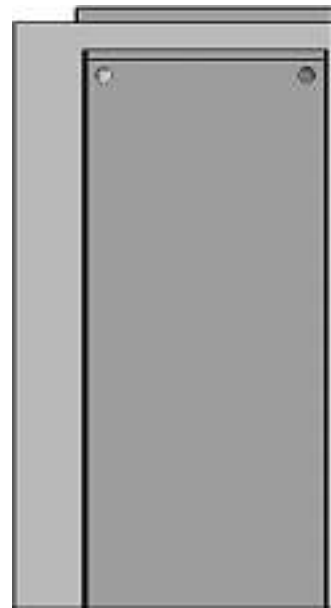

MSIE001CH5

Cl. 20-02 133 253 29.09.2006  
 3 Design – Präsentationselement  
 Hinterleger: Und Produktionen Zürich Gestaltungsatelier  
 GmbH, Zimmerlistrasse 6, 8004 Zürich  
 Designer: Daniel Simmen, Zürich



looptool\_a



looptool\_b



looptool\_c

Cl. 21-01 133 254 22.09.2006  
 1 design – giocattolo  
 Depositante: Viviana Chiosi, via Berté, 6533 Lumino

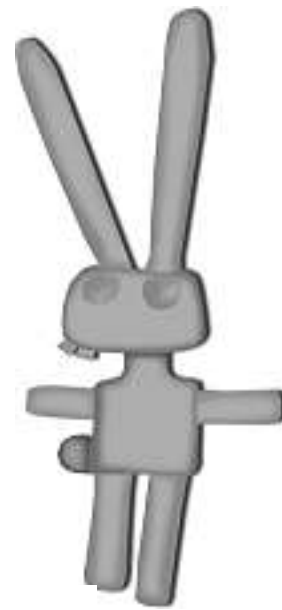

19-Milcaro

Cl. 21-02 133 255 09.08.2006  
 2 Design – Ball-Korb, Spielfeld  
 Hinterleger: Loreto-Ximena Silva-Robledo,  
 Landskronstrasse 75, 4056 Basel



City Ball 1

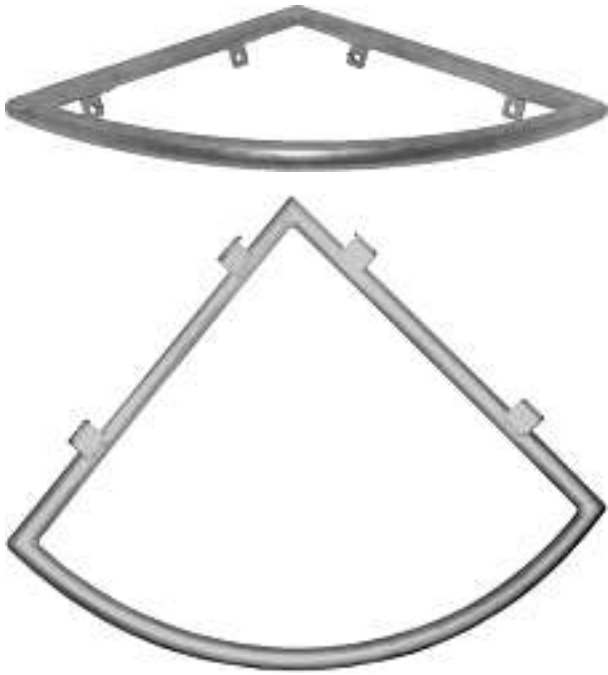

City Ball 2

Cl. 24-04                      133 258                      25.09.2006  
1 Design – Inhalator  
Hinterleger: Bang & Olufsen Medicom A/S,  
Gimsinglundvej 20, Struer, DK  
Designer: Rasmus Løgstrup Jensen, Aarhus;  
Carsten Pedersen, Aarhus  
Vertreter: A.W. Metz & Co. AG, 8024 Zürich  
Priorität: DK, 07.09.2006

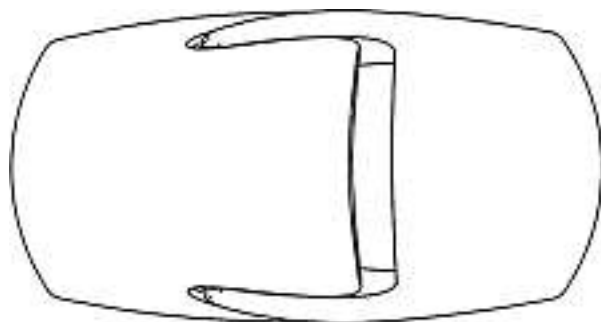
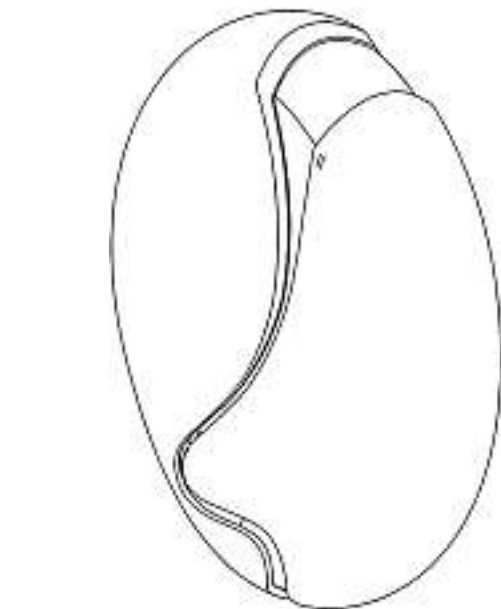
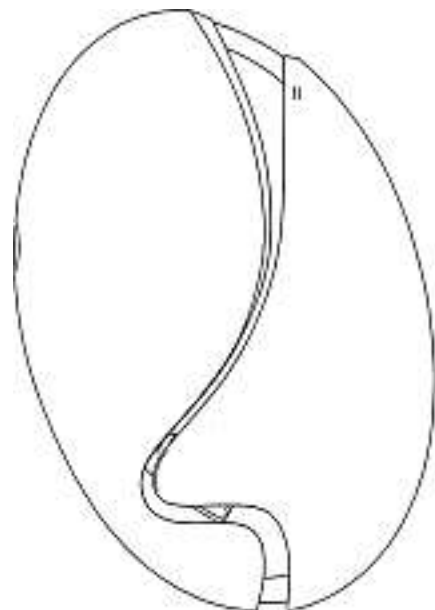
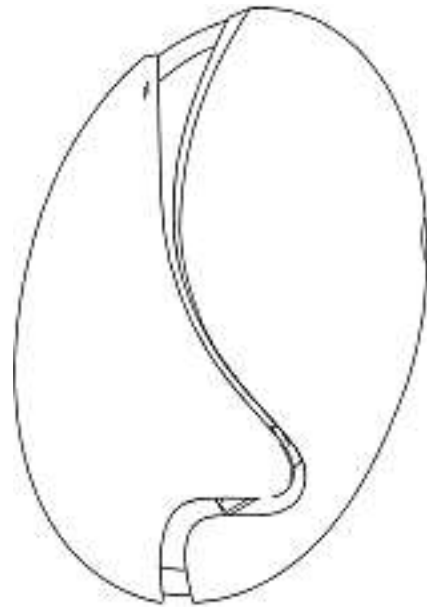
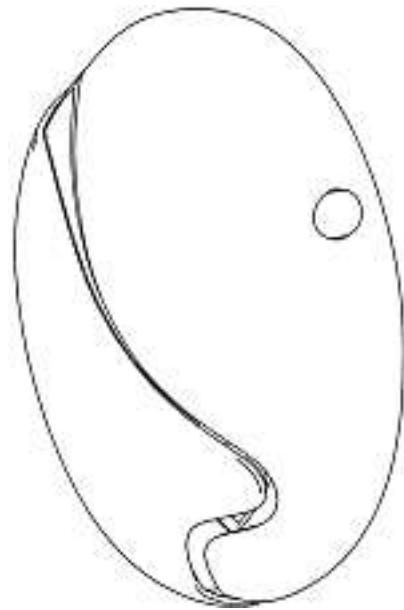



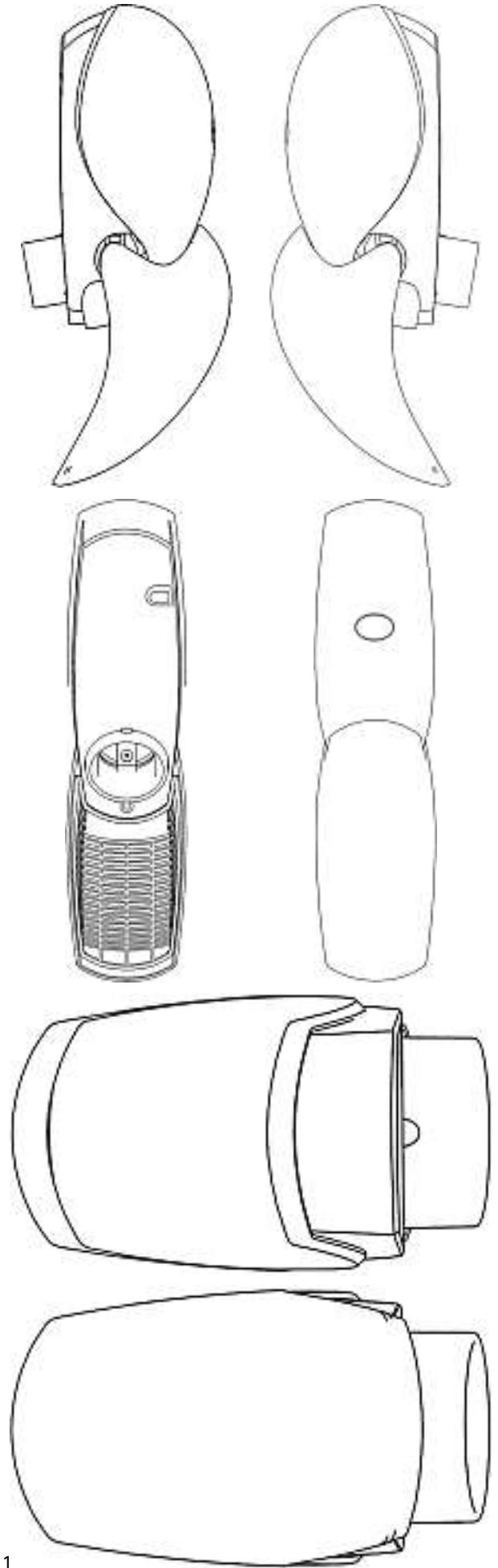
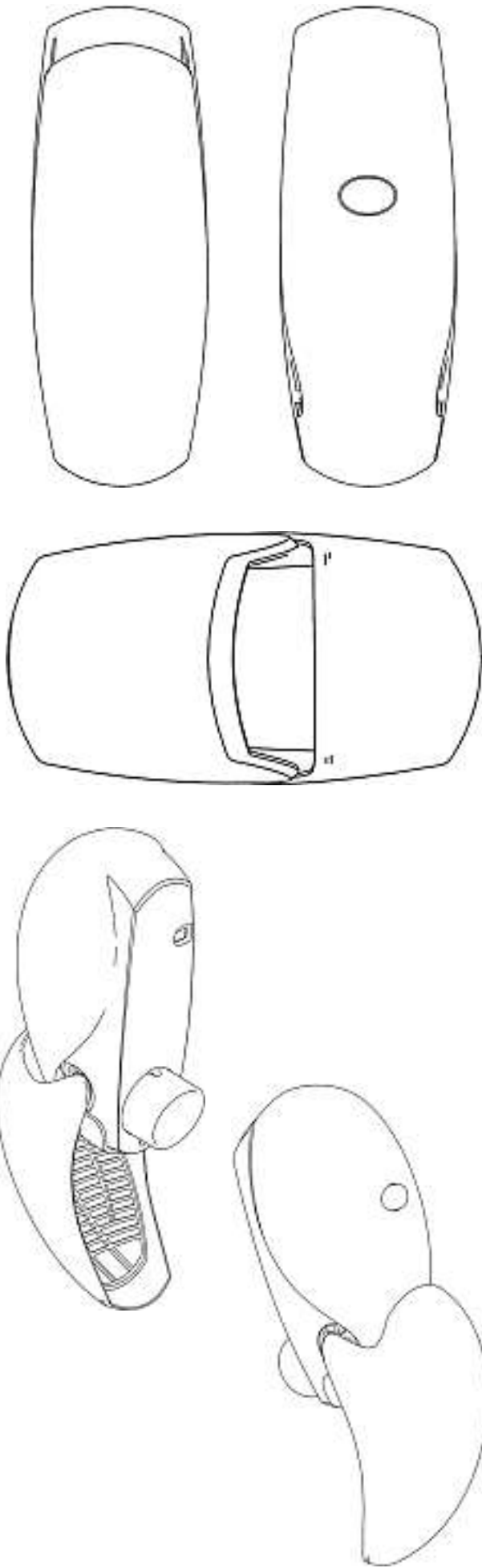

1

Cl. 25-02 133 259 29.09.2006  
 2 Design – Anbaubalkon  
 Hinterleger: Werzalit AG + Co. KG, Gronauer Strasse 70,  
 Oberstenfeld, DE  
 Designer: Harald Siegle, Stuttgart  
 Vertreter: A. Braun, Braun, Héritier, Eschmann AG,  
 Patentanwälte, 4051 Basel  
 Priorität: EM, 30.03.2006



D35223CH00-1

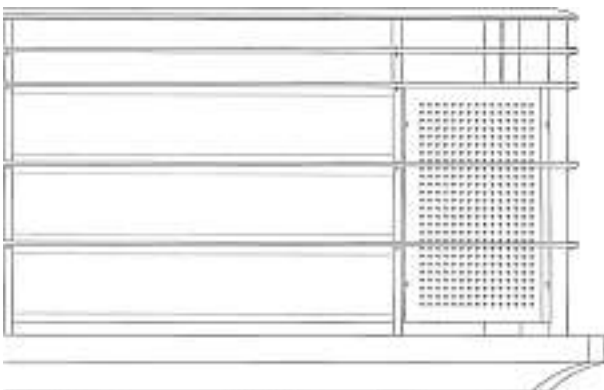

D35223CH00-2

Cl. 25-03 133 260 25.09.2006  
 1 Design – Wohnmodul  
 Hinterleger: Andreas Vils, Via Davitg 4, 7403 Rhäzüns

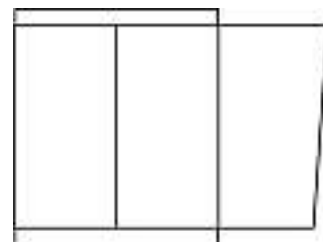
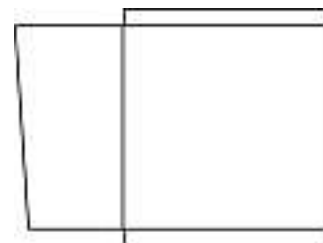
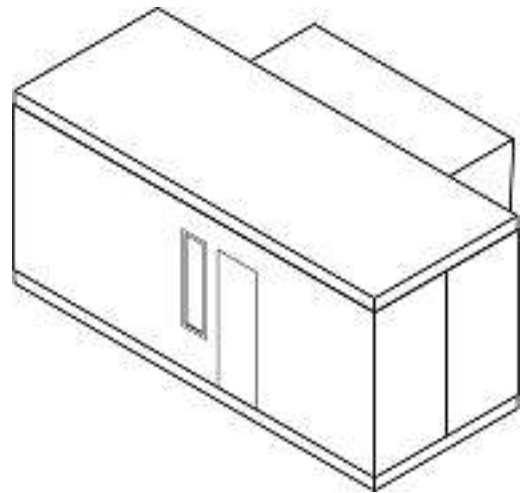
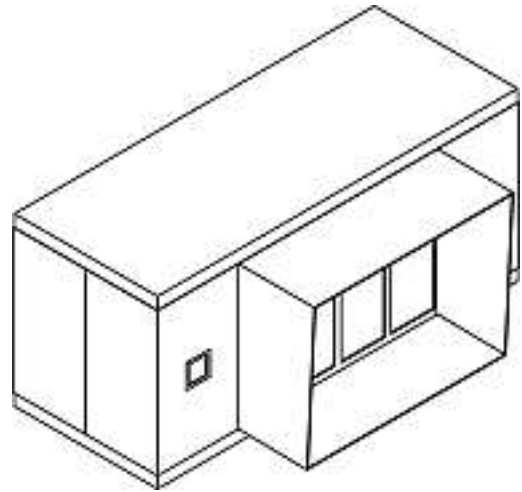
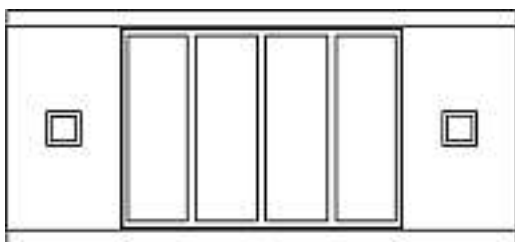

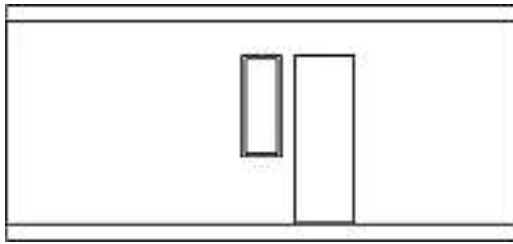

a

Cl. 26-04                      **133 261**                      27.09.2006  
 1 Design – Kerze  
 Hinterleger: Manfred Gruber, Frigadenstrasse 24,  
 8739 Rieden  
 Vertreter: Schneider Feldmann AG, Patent- und  
 Markenanwälte, 8022 Zürich



4

Cl. 26-05                      **133 262**                      29.09.2006  
 2 Design – Lampen  
 Hinterleger: Belux AG, Klünenfeldstrasse 20, 4132 Muttenz  
 Designer: Daniel Kübler, Zürich  
 Vertreter: AXON Patent GmbH, 4147 Aesch

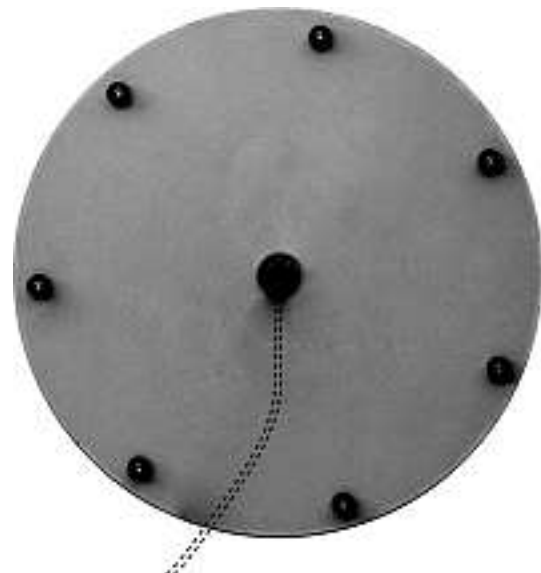

1



Cl. 26-05 133 263 02.10.2006  
2 Design – Leuchten  
Hinterleger: Trilux-Lenze GmbH & Co. KG, Heidestrasse 4,  
Arnsberg, DE  
Designer: Michael Sieger, Sassenberg  
Vertreter: Ammann Patentanwälte AG Bern, 3001 Bern  
Priorität: EM, 19.04.2006; EM, 19.04.2006





Polaron 2

Cl. 26-05 133 264 02.10.2006  
2 Design – Leuchten  
Hinterleger: Trilux-Lenze GmbH & Co. KG, Heidestrasse 4, Arnsberg, DE  
Designer: Kai Lüchow, Nürnberg  
Vertreter: Ammann Patentanwälte AG Bern, 3001 Bern  
Priorität: EM, 19.04.2006; EM, 19.04.2006



DECA 1





DECA 2

### Verlängerungen Prolongations Prolongazioni

119 303 Cl. 21-01 3 Design

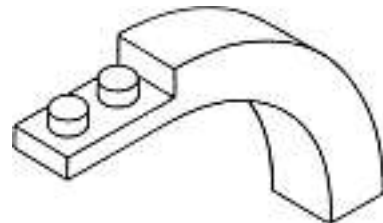
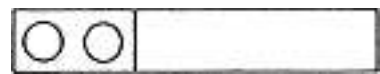
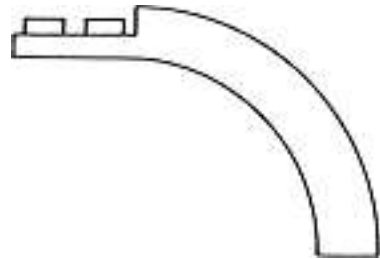
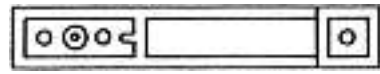

1

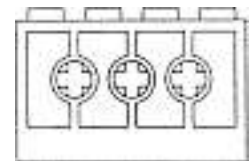
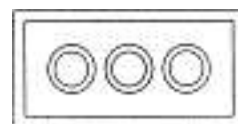
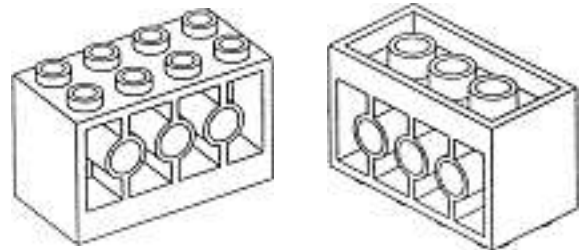

2

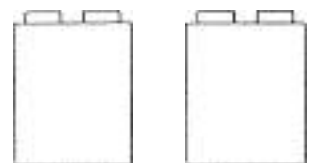
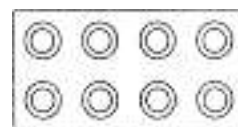

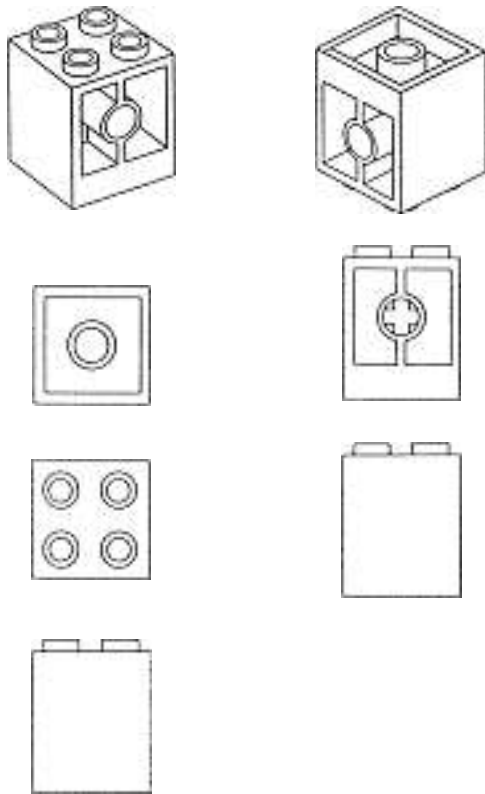

3

119 316 Cl. 08-05 1 Design



1

123 697	Cl.	09-01	6 Design
123 734	Cl.	07-01	1 design
123 769	Cl.	28-03	2 Design
123 788	Cl.	13-03	1 Design
123 790	Cl.	14-02	1 Design
123 850	Cl.	14-01	1 Design
123 874	Cl.	10-04	1 Design
123 898	Cl.	07-02	2 Design
127 929	Cl.	02-01	3 Design
128 011	Cl.	06-09	1 Design
128 344	Cl.	07-01	1 Design
128 353	Cl.	09-03	3 Design
128 369	Cl.	24-02	1 Design
128 374	Cl.	26-05	3 Design
128 381	Cl.	06-01	3 Design
128 438	Cl.	11-01	78 Design
128 465	Cl.	09-05	1 design
128 491	Cl.	06-04	1 Design
128 504	Cl.	11-01	3 design
128 512	Cl.	21-01	1 design
128 534	Cl.	07-02	26 Design
128 537	Cl.	09-01	1 Design
128 589	Cl.	10-02	1 Design

**Mutationen  
Modifications  
Modificazioni**

130 098

130 948

130 985

130 989

131 427

131 945

131 989

132 006

132 170

132 246

Transmission

Déposant: Cartier Création Studio SA,

Boulevard James-Fazy 8, 1201 Genève

Mandataire: Richemont International SA, 1293 Bellevue

132 787

Neuer Vertreter

Vertreter: Ritscher &amp; Partner AG, 8702 Zollikon

132 904

Namensänderung

Hinterleger: Confindustria, Grabenstrasse 8, 6300 Zug

**Löschungen  
Radiations  
Radiazioni**

118 864	Cl.	14-02	1	Design
118 865	Cl.	14-02	1	Design
118 866	Cl.	14-02	1	Design
118 867	Cl.	14-02	1	Design
118 911	Cl.	10-02	4	design
118 996	Cl.	10-05	1	Design
123 211	Cl.	07-01	11	Design
123 217	Cl.	10-02	4	Design
123 219	Cl.	10-07	1	Design
123 222	Cl.	11-01	2	design
123 227	Cl.	14-02	1	Design
123 232	Cl.	20-03	1	Design
123 235	Cl.	26-05	2	Design
123 265	Cl.	24-02	1	design
123 266	Cl.	24-02	1	design
123 280	Cl.	08-08	2	Design
123 284	Cl.	10-02	1	Design
123 309	Cl.	10-02	2	Design
123 327	Cl.	06-01	4	Design
127 870	Cl.	06-03	3	Design
127 892	Cl.	14-02	1	Design
127 900	Cl.	27-03	1	Design
127 905	Cl.	06-03	27	Design
127 907	Cl.	06-04	3	Design
127 911	Cl.	09-03	9	Design
127 913	Cl.	12-05	2	Design
127 917	Cl.	18-01	18	design
127 919	Cl.	19-08	1	Design
127 920	Cl.	21-02	1	Design
127 922	Cl.	23-02	1	Design
127 923	Cl.	24-04	1	design
127 924	Cl.	24-04	2	design
127 925	Cl.	25-03	3	design
127 926	Cl.	26-05	1	Design
127 931	Cl.	03-01	1	Design
127 932	Cl.	03-01	1	design
127 949	Cl.	10-05	3	Design
127 982	Cl.	11-01	9	Design
127 994	Cl.	24-02	1	Design
128 004	Cl.	04-02	1	Design
128 030	Cl.	16-06	1	Design
128 062	Cl.	14-03	2	Design