

## Nationale Hinterlegungen

In der folgenden Liste werden die beim Eidgenössischen Institut für Geistiges Eigentum hinterlegten Designs publiziert. Dabei sind der Reihe nach angegeben:

- internationale Klassenangaben
- Hinterlegungsnummer
- Hinterlegungsdatum
- Allenfalls Aufschub der Veröffentlichung
- Anzahl der hinterlegten Designs
- Bezeichnung
- Name und Wohnsitz des Hinterlegers oder der Hinterlegerin
- gegebenenfalls Name und Wohnsitz des Designers oder der Designerin
- Name und Geschäftssitz des allfälligen Vertreters oder der Vertreterin
- gegebenenfalls Prioritätsangaben
- gegebenenfalls Beschreibungstext
- Ordnungsnummer
- Reproduktion des Designs

## Internationale Hinterlegungen

Die bei der Weltorganisation für geistiges Eigentum in Genf hinterlegten Muster und Modelle mit Benennung Schweiz geniessen den gleichen Schutz wie national hinterlegte Designs. Sie werden jeweils im Blatt «Bulletin des dessins et modèles internationaux» veröffentlicht. Dieses Publikationsorgan ist deshalb für eine vollständige Recherche unbedingt beizuziehen.

## Topographien

Angaben über die vom Eidgenössischen Institut für Geistiges Eigentum eingetragenen Topographien von Halbleitererzeugnissen werden in folgender Anordnung aufgeführt:

- Eintragsnummer
- Anmeldedatum
- Bezeichnung
- Name und Wohnsitz des Anmelders oder der Anmelderin
- gegebenenfalls Name und Wohnsitz des Herstellers oder der Herstellerin
- Name und Geschäftssitz des oder der allfälligen Bevollmächtigten
- Datum und Ort einer allfälligen ersten geschäftlichen Verbreitung der Topographie

## Dépôts nationaux

Les designs déposés à l'Institut Fédéral de la Propriété Intellectuelle sont publiés dans la liste qui suit. Les indications y relatives sont mentionnées dans cet ordre:

- indications des classes internationales
- numéro de dépôt
- date de dépôt
- le cas échéant, ajournement de la publication
- nombre des designs déposés
- désignation
- nom et domicile du/de la déposant/e
- le cas échéant, nom et domicile du/de la designer
- nom et domicile de l'éventuel/le mandataire
- le cas échéant, indication de priorité
- le cas échéant, description du design
- numéro attribué à chaque design
- reproduction du design

## Dépôts internationaux

Les dessins et modèles déposés à l'Organisation Mondiale de la Propriété Intellectuelle à Genève qui désignent la Suisse jouissent de la même protection que les dépôts nationaux. Ils sont chaque fois publiés dans la feuille «Bulletin des dessins et modèles internationaux». Pour une recherche complète, il est indispensable de consulter ledit organe de publication.

## Topographies

Les indications concernant les topographies des produits semi-conducteurs, enregistrées par l'Institut Fédéral de la Propriété Intellectuelle, sont énumérées dans l'ordre suivant:

- numéro d'enregistrement
- date de dépôt
- désignation
- nom et domicile du/de la déposant/e
- le cas échéant, nom et domicile du/de la producteur/trice
- nom et domicile de l'éventuel/le mandataire
- date et lieu d'une éventuelle première mise en circulation de la topographie

## Depositi nazionali

Nella lista seguente vengono pubblicati i design depositati presso l'Istituto Federale della Proprietà Intellettuale. Sono menzionati nel seguente ordine:

- indicazioni delle classi internazionali
- numero di deposito
- data del deposito
- se del caso, indicazione che la pubblicazione è stata differita
- numero dei design depositati
- designazione
- nome e domicilio del depositante
- se del caso, nome e domicilio del designer
- nome e sede di un eventuale mandatarario
- se del caso, indicazioni di priorità
- se del caso, descrizione del design
- numero d'ordine
- riproduzione del design

## Depositi internazionali

I disegni e modelli depositati presso l'Organizzazione Mondiale della Proprietà Intellettuale a Ginevra con denominazione Svizzera godono della medesima protezione del deposito nazionale. Essi vengono pubblicati ogni volta nel foglio «Bulletin des dessins et modèles internationaux». Quest'organo di pubblicazione è da consultare se si vuole effettuare una ricerca completa.

## Topografie

Le indicazioni concernenti le topografie di prodotti a semiconduttori depositati presso l'Istituto Federale della Proprietà Intellettuale sono menzionate nell'ordine seguente:

- numero di registrazione
- data del deposito
- designazione
- nome e domicilio del/la richiedente
- se del caso, nome e domicilio del/la produttore/trice
- nome e sede di un eventuale mandatarario
- data e luogo di un'eventuale prima messa in circolazione della topografia

**Hinterlegungen**

**Dépôts**

**Depositi**

Cl. 11-01 130 146 25.11.2003

1 design – pendentif

Déposant: Simon Tavitian, 7, rue Le Corbusier, 1208 Genève

Mandataire: Bugnion S.A., 1211 Genève 12 - Champel

Description du design: Le pendentif a la forme d'une sucette formée d'une boule sphérique surmontée d'une tige, la partie sphérique étant munie d'un renflement annulaire et étant montée pivotante par rapport à la tige.

Fin de la période ajournement de la publication

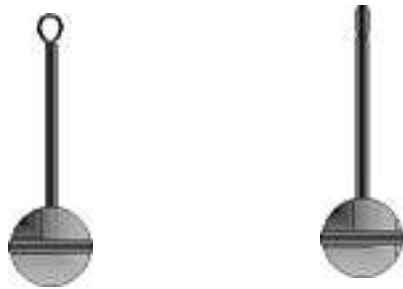

1

Cl. 10-02, 10-07 130 297 17.02.2004

3 design – montre, boîte de montre, montre-bracelet

Déposant: Harry Winston Ultimate, Timepiece S.A.,

82, rue de Lausanne, 1202 Genève

Designer: Philippe Plan, Satigny

Mandataire: Inteltech SA, 2001 Neuchâtel

Fin de la période ajournement de la publication

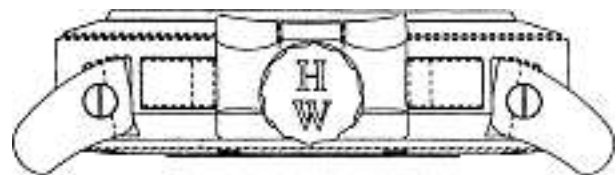
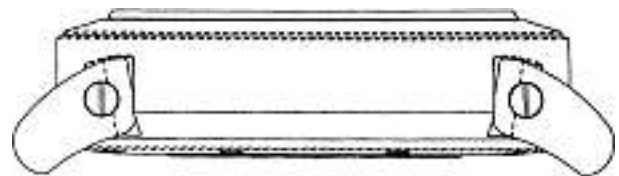

1

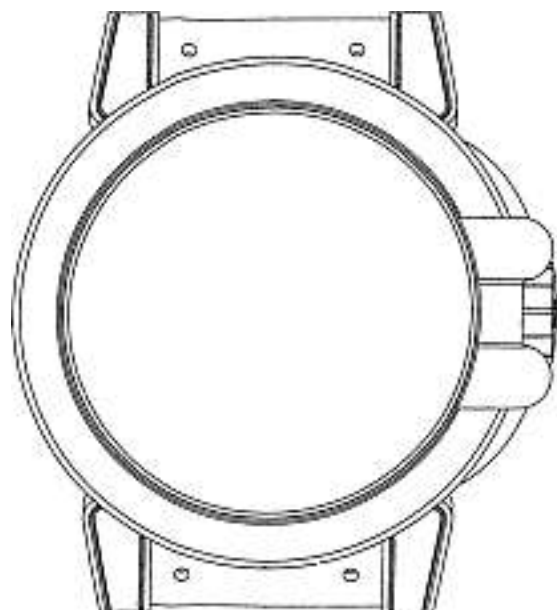

2



3

Cl. 10-02                      **130 576**                      04.05.2004  
 1 design – montre-bracelet  
 Déposant: The British Masters SA,  
 Avenue Léopold-Robert 23, 2300 La Chaux-de-Fonds  
 Designer: Eric A. Loth, La Chaux-de-Fonds  
 Mandataire: Inteltech SA, 2001 Neuchâtel  
 Fin de la période ajournement de la publication



1

Cl. 17-05 130 644 18.05.2004  
 1 design – mouvement à musique  
 Déposant: Reuge S.A., 26, rue des Rasses, 1450 Ste-Croix  
 Designer: Etienne Ruffieux, Posat  
 Mandataire: Inteltech SA, 2001 Neuchâtel  
 Fin de la période ajournement de la publication

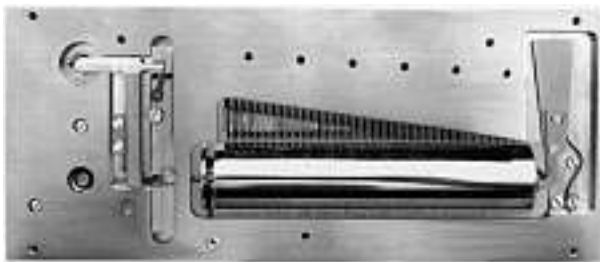
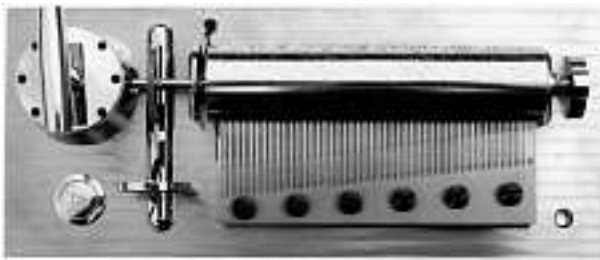

Cl. 10-02 130 724 24.06.2004  
 9 design – montres-bracelets  
 Déposant: Luxury Timepieces International SA,  
 Ch. des Rochettes 2, 2016 Cortaillod  
 Designer: Dino Modolo, La Chaux-de-Fonds  
 Mandataire: Inteltech SA, 2001 Neuchâtel  
 Fin de la période ajournement de la publication





158000/010192



158000/010292





158000/010392

158000/010492



158000/010592





158000/010692





158000/010792



158000/010892





158000/010992



Cl. 10-02                      **131 169**                      24.11.2004  
 2 design – montres-bracelets  
 Déposant: The British Masters SA,  
 Avenue Léopold-Robert 23, 2300 La Chaux-de-Fonds  
 Designer: Eric A. Loth, La Chaux-de-Fonds  
 Mandataire: Inteltech SA, 2001 Neuchâtel  
 Fin de la période ajournement de la publication



1





Cl. 10-07 131 170 23.11.2004  
 1 design – boîtier de montre  
 Déposant: LINDE WERDELIN, Skovgaardsvej 7B,  
 Charlottenlund, DK  
 Designer: Morten Linde, Klampenborg  
 Mandataire: B.M.G. Avocats, 1211 Genève 12  
 Fin de la période ajournement de la publication





BIFORMETER

Cl. 10-07                      **131 286**                      29.12.2004  
 3 design – boîtes de montre  
 Déposant: Reuge S.A., 26, rue des Rasses, 1450 Ste-Croix  
 Designer: Etienne Ruffieux, Posat  
 Mandataire: Inteltech SA, 2001 Neuchâtel  
 Fin de la période d'ajournement de la publication

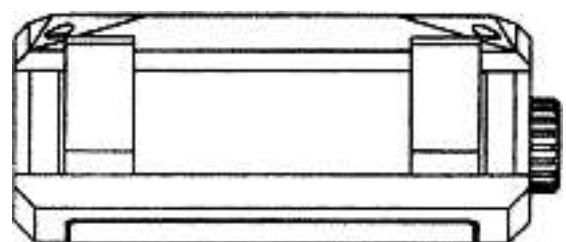
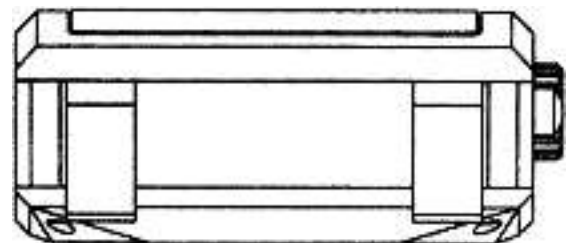
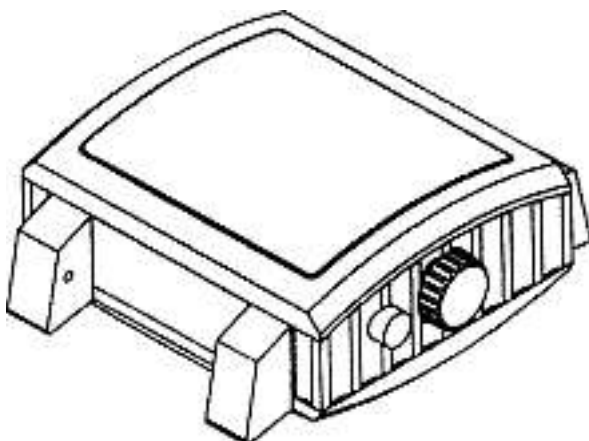
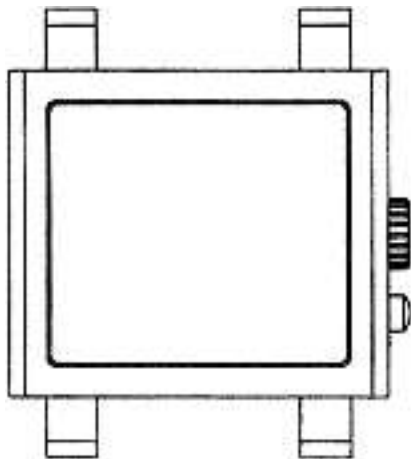
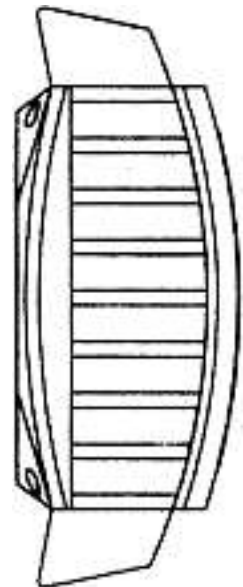
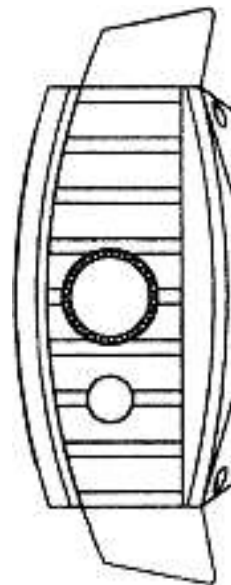
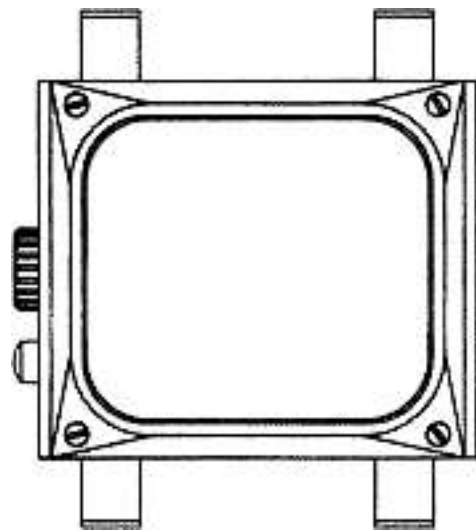

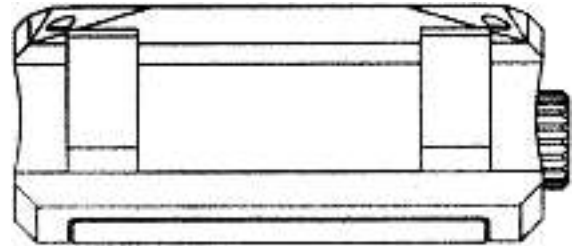
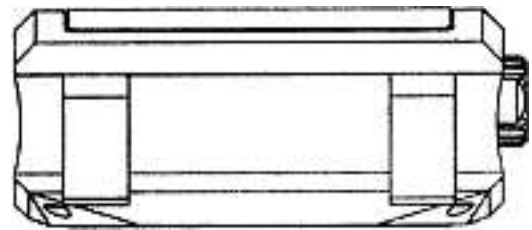
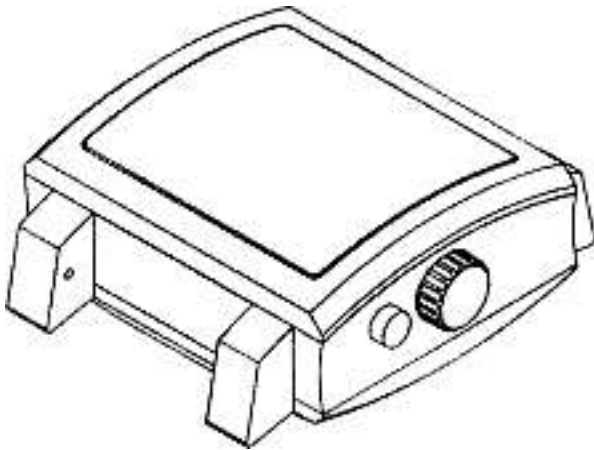
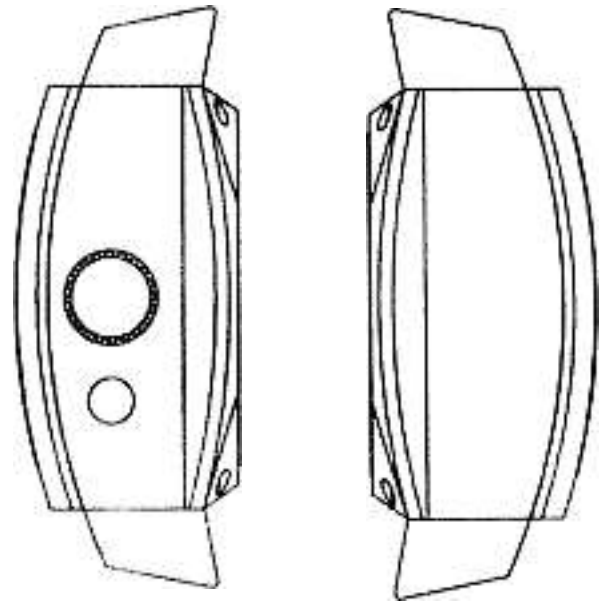
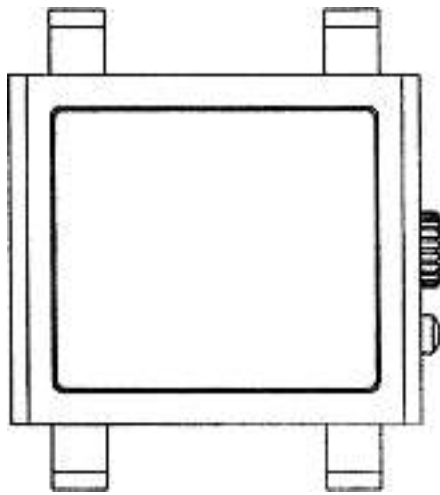

2

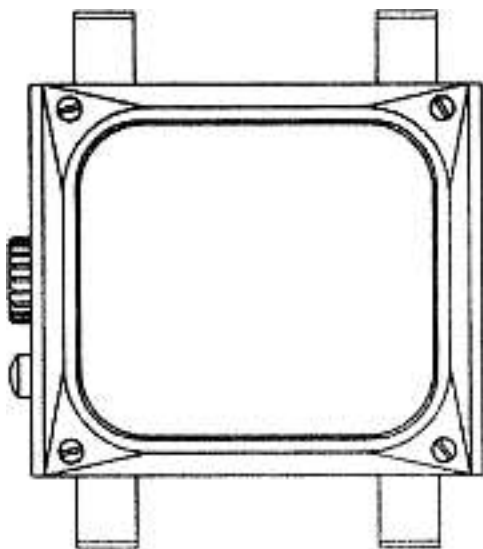

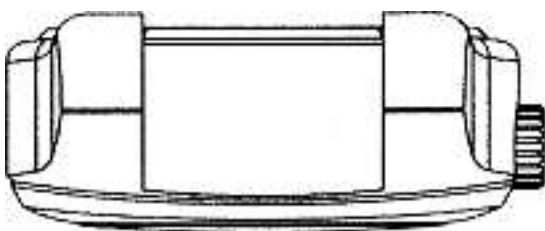
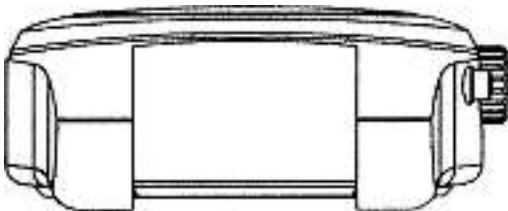
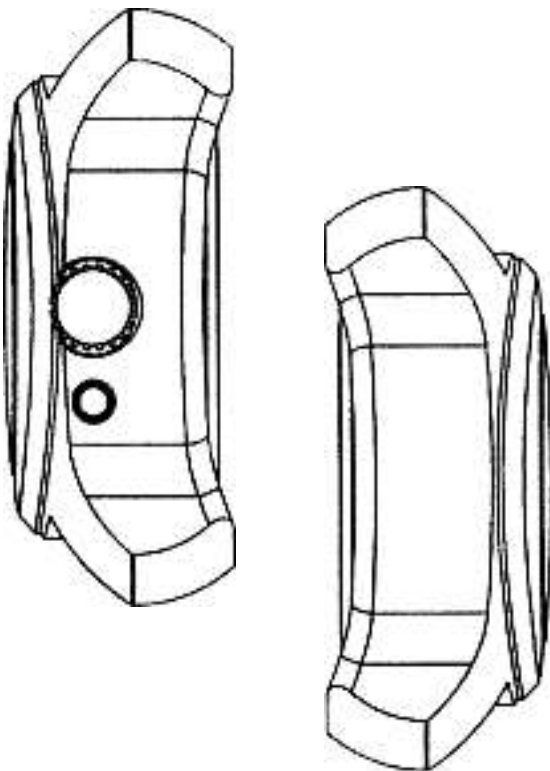
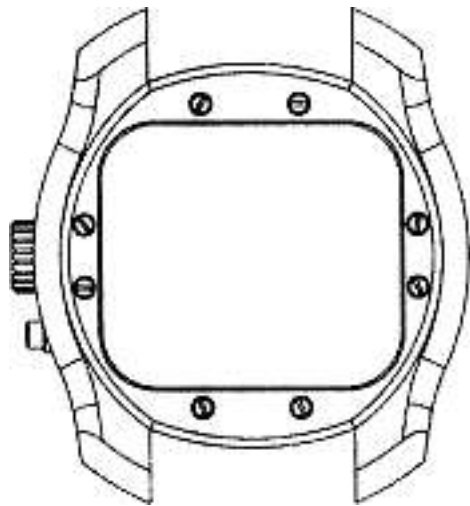

3

Cl. 10-02, 10-07 131 330 05.01.2005  
2 design – boîte de montre, montre-bracelet  
Déposant: Pierre DeRoche SA, Le Revers 1, 1345 Le Lieu  
Designer: Emmanuel Gueit, Genève  
Mandataire: Inteltech SA, 2001 Neuchâtel  
Fin de la période ajournement de la publication



1



2



Cl. 10-02      **131 421**      24.02.2005  
 2 design – montres-bracelets  
 Déposant: Montres Corum Sàrl, 1, rue du Petit-Château,  
 2300 La Chaux-de-Fonds  
 Designer: Severin Wunderman, Los Angeles  
 Mandataire: Inteltech SA, 2001 Neuchâtel  
 Fin de la période ajournement de la publication



1





2

Cl. 10-02 131 529 09.03.2005  
2 design – montres-bracelets  
Déposant: Pierre DeRoche SA, Le Revers 1, 1345 Le Lieu  
Designer: Emmanuel Gueit, Genève  
Mandataire: Inteltech SA, 2001 Neuchâtel  
Fin de la période ajournement de la publication







1



2

Cl. 10-07 131 530 09.03.2005  
 16 design – cadrans de montre  
 Déposant: Pierre Kunz SA, 46, Chemin des Troiselles,  
 1294 Genthod  
 Designer: Pierre Kunz, Genève  
 Mandataire: Inteltech SA, 2001 Neuchâtel  
 Fin de la période ajournement de la publication

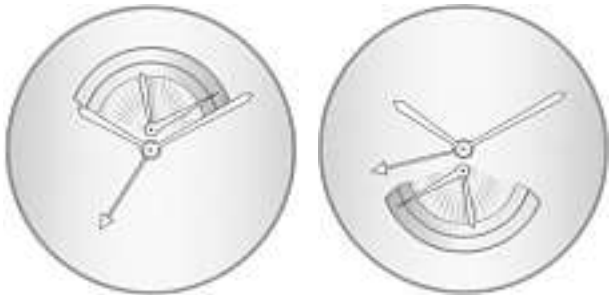

1 2

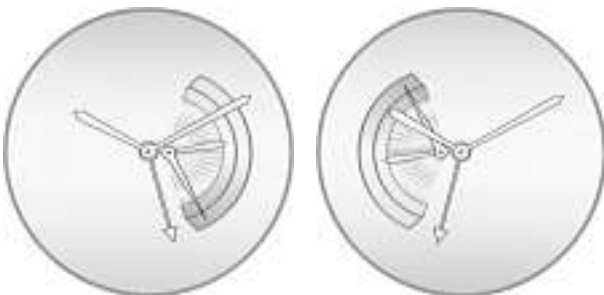

3 4

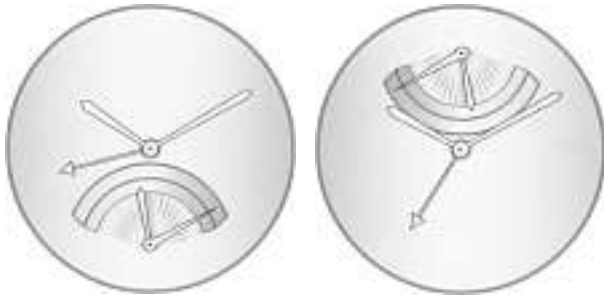

5 6

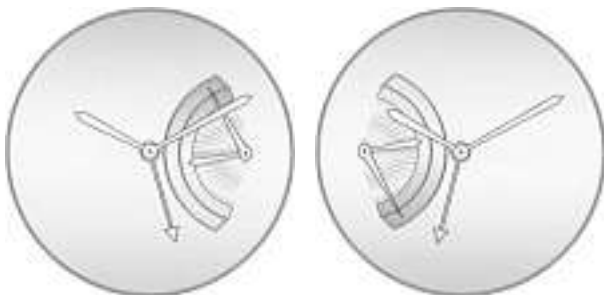

7 8

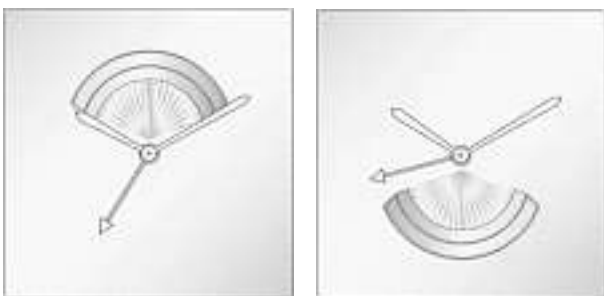

9 10

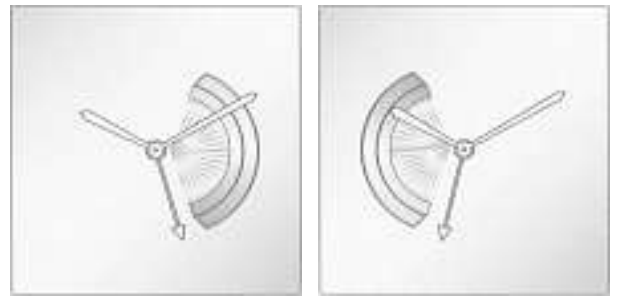

11 12

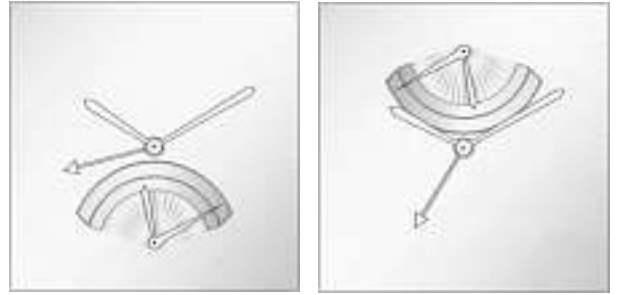

13 14

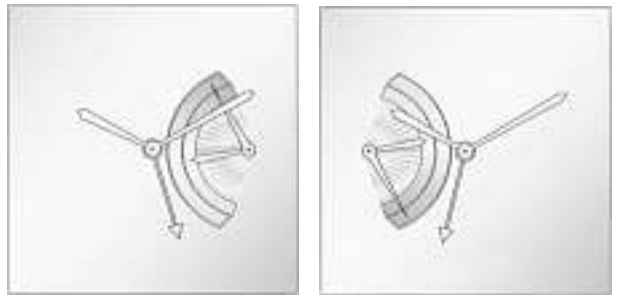

15 16

Cl. 10-02 10-07 131 584 18.03.2005  
 2 design – montre-bracelet, montre  
 Déposant: François-Paul Journe, 17, rue de l'Arquebuse,  
 1204 Genève  
 Mandataire: Inteltech SA, 2001 Neuchâtel  
 Fin de la période ajournement de la publication





1



2

Cl. 10-02      **131 585**      23.03.2005  
 1 design – montre-bracelet  
 Déposant: Pierre Kunz SA, 46, Chemin des Troiselles,  
 1294 Genthod  
 Designer: Pierre Kunz, Genève  
 Mandataire: Inteltech SA, 2001 Neuchâtel  
 Fin de la période ajournement de la publication



1

Cl. 10-02 131 586 29.03.2005  
 1 design – montre-bracelet  
 Déposant: Desco von Schulthess AG, Brandschenkestrasse 2,  
 8002 Zürich  
 Designer: Sandro Reginelli, Neuchâtel  
 Mandataire: Inteltech SA, 2000 Neuchâtel  
 Fin de la période ajournement de la publication



1

Cl. 10-02, 10-07 131 587 29.03.2005  
 3 design – montres-bracelets, montre  
 Déposant: Montres Corum Sàrl, 1, rue du Petit-Château,  
 2300 La Chaux-de-Fonds  
 Designer: Severin Wunderman, Los Angeles  
 Mandataire: Inteltech SA, 2000 Neuchâtel  
 Fin de la période ajournement de la publication





1



2



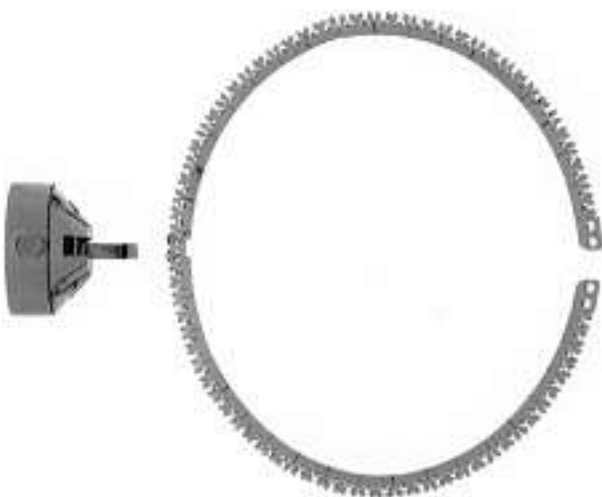

3

Cl. 10-07 **131 589** 23.03.2005  
 2 design – montre, dispositif d'indication de dates  
 Déposant: Harry Winston Ultimate Timepiece SA,  
 82, rue de Lausanne, 1202 Genève  
 Designer: Maximilian Büsser, Genève  
 Mandataire: Inteltech SA, 2000 Neuchâtel  
 Fin de la période ajournement de la publication



1



2

Cl. 10-02 **131 650** 11.04.2005  
 1 design – montre-bracelet  
 Déposant: Luxury Timepieces International SA,  
 Ch. des Rochettes 2, 2016 Cortaillod  
 Designer: Dino Modolo, La Chaux-de-Fonds  
 Mandataire: Inteltech SA, 2001 Neuchâtel  
 Fin de la période ajournement de la publication



1



Cl. 10-02 **131 651** 22.04.2005

1 design – montre-bracelet  
Déposant: Montres Corum Sàrl, 1, rue du Petit-Château,  
2300 La Chaux-de-Fonds

Designer: Severin Wunderman, Los Angeles

Mandataire: Inteltech SA, 2000 Neuchâtel  
Fin de la période ajournement de la publication





Cl. 10-02 131 713 26.04.2005  
2 design – montres-bracelets  
Déposant: CHANEL SAS, 135, av. Charles de Gaulle,  
Neuilly sur Seine Cedex, FR  
Designer: Jacques Helleu, Neuilly sur Seine  
Mandataire: Inteltech SA, 2001 Neuchâtel  
Fin de la période ajournement de la publication







1



2

Cl. 10-02 131 714 26.04.2005

1 design – montre-bracelet

Déposant: Pierre Kunz SA, 46, Chemin des Troiselles, 1294 Genthod

Designer: Pierre Kunz, Genève

Mandataire: Inteltech SA, 2001 Neuchâtel

Fin de la période ajournement de la publication





Cl. 10-02 131 715 26.04.2005  
3 design – montres-bracelets  
Déposant: LUXURY GRIFFES SA, Largo L. Olgiati 75a,  
6512 Giubiasco  
Designer: Gérald Genta, Monaco  
Mandataire: Inteltech SA, 2001 Neuchâtel  
Fin de la période ajournement de la publication



1



2





Cl. 10-02 131 763 25.05.2005  
8 design – montres-bracelets  
Déposant: Daniel Roth et Gérald Genta Haute Horlogerie SA,  
Chemin du Grand-Puits 42, 1217 Meyrin  
Designer: Jérémie Senggen, Lausanne; Jean-Marc Salemi,  
Morges  
Mandataire: Inteltech SA, 2001 Neuchâtel  
Fin de la période ajournement de la publication





1



2





4



5









7



8

Cl. 10-07 131 807 30.05.2005

5 design – montres et boucles de montres  
 Dépositant: Luxury Timepieces International SA,  
 Ch. des Rochettes 2, 2016 Cortaillod  
 Designer: Christian Bédard, Genève  
 Mandataire: Inteltech SA, 2001 Neuchâtel  
 Fin de la période ajournement de la publication



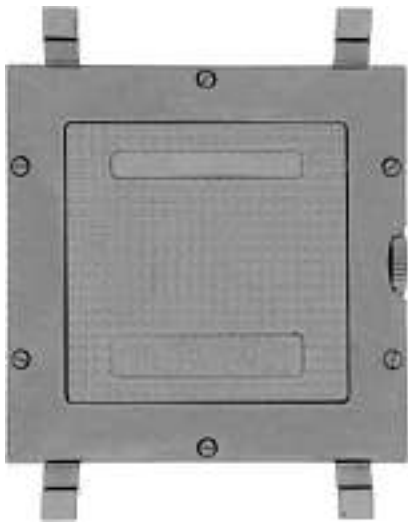

1

2





4

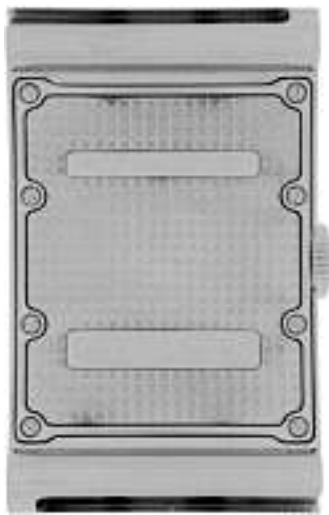

3

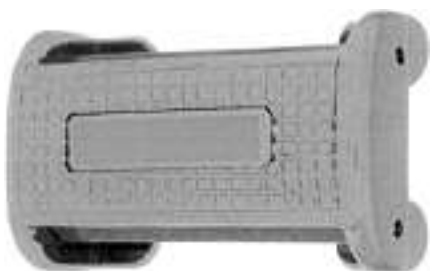

5

Cl. 10-07 132 472 02.01.2006  
 1 design – cadran de montre  
 Déposant: Daniel Roth et Gérald Genta Haute Horlogerie SA,  
 Chemin du Grand-Puits 42, 1217 Meyrin  
 Designer: Jérémie Senggen, Lausanne  
 Mandataire: Inteltech SA, 2001 Neuchâtel  
 Fin de la période ajournement de la publication



1

Cl. 10-07 132 473 02.01.2006  
 24 design – cadrans de montres  
 Déposant: Daniel Roth et Gérald Genta Haute Horlogerie SA,  
 Chemin du Grand-Puits 42, 1217 Meyrin  
 Designer: Jérémie Senggen, Lausanne; Jean-Marc Salemi,  
 Morges  
 Mandataire: Inteltech SA, 2001 Neuchâtel  
 Fin de la période ajournement de la publication



01

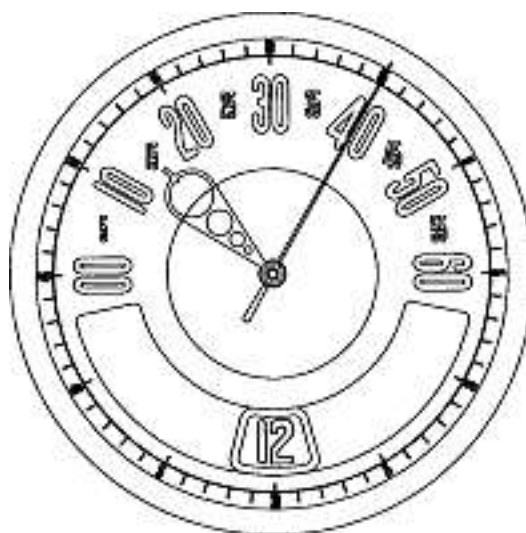

02



03

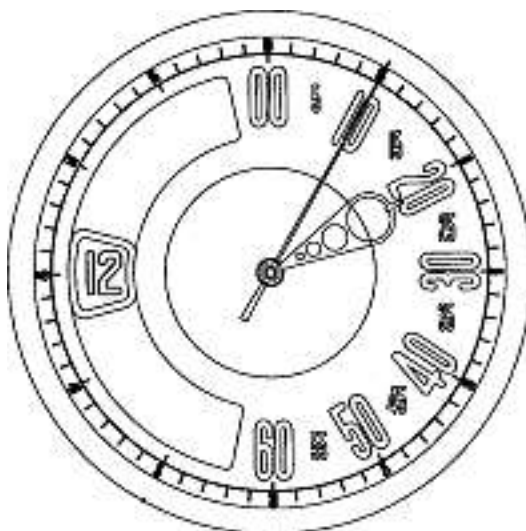

04



05



08



06



09



07



10



11

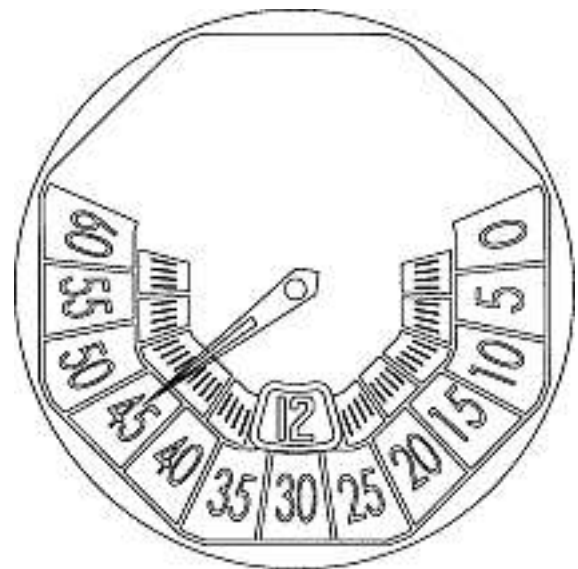

14



12

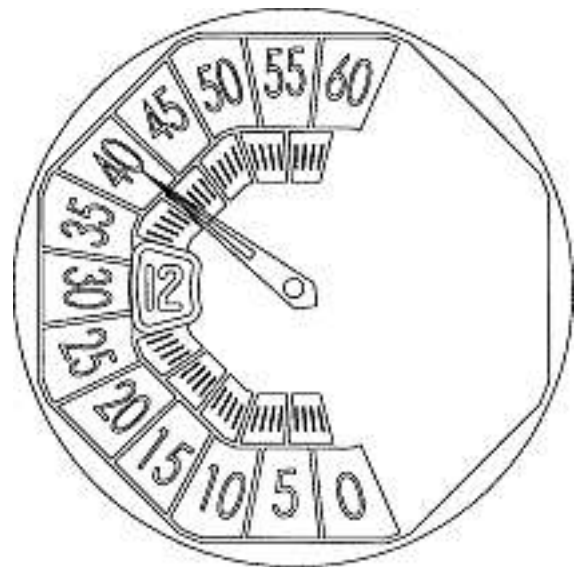

15

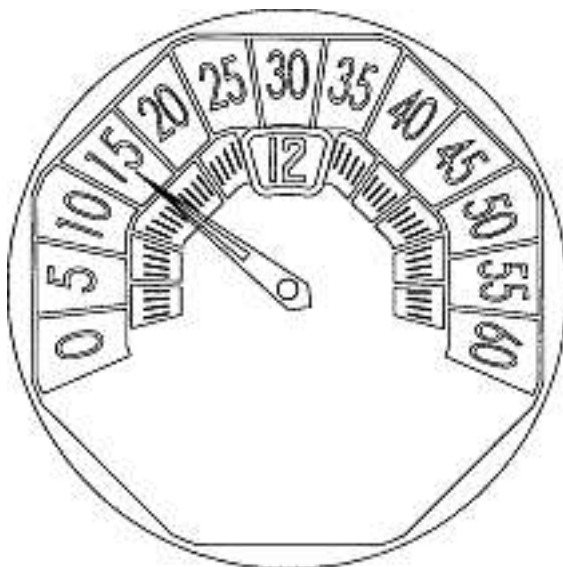

13

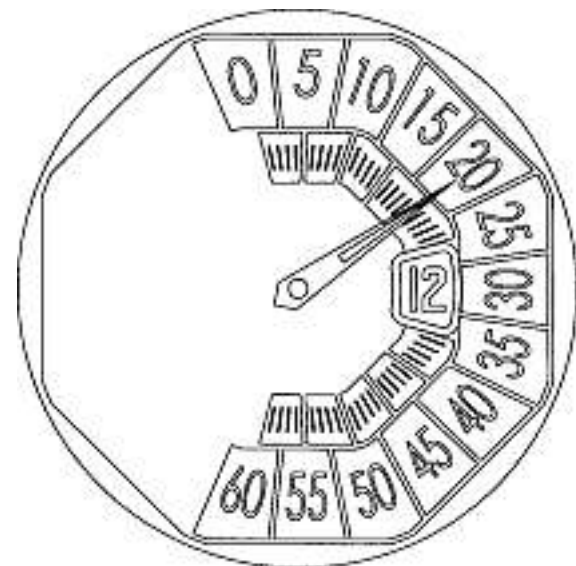

16





17



20

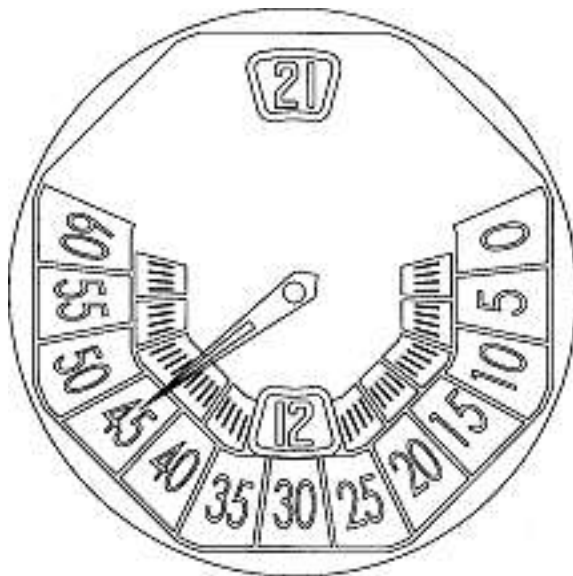

18



21

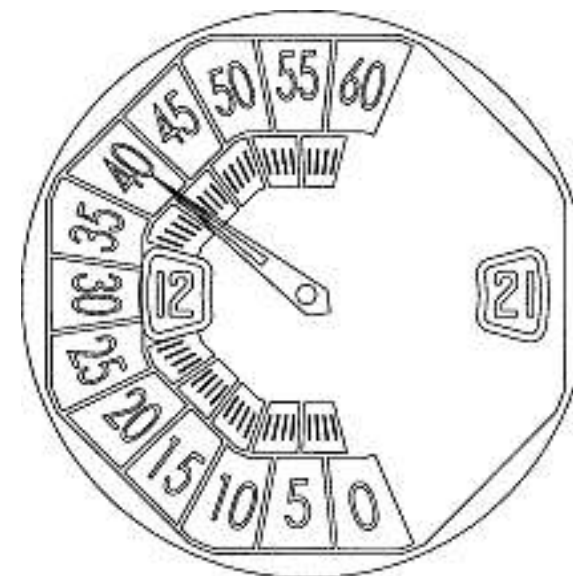

19

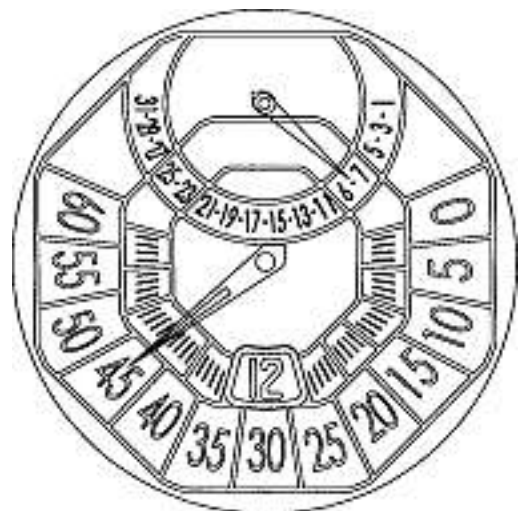

22

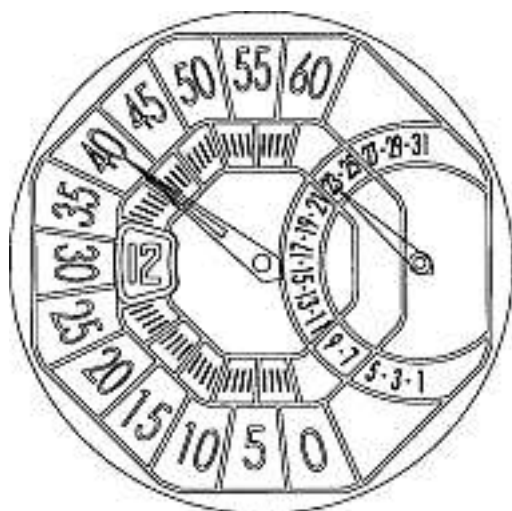

23

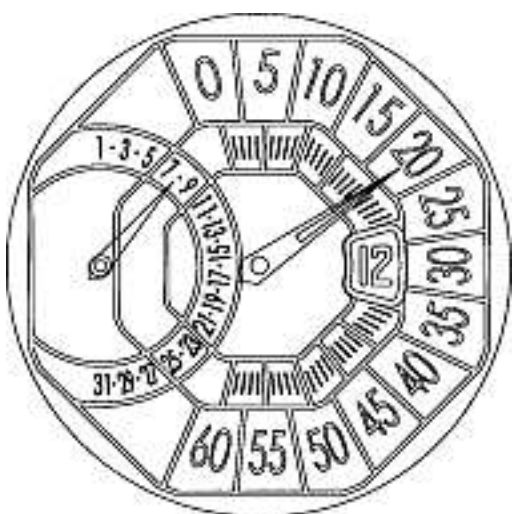

24

Cl. 10-02, 10-07      **132 562**      03.02.2006  
 2 design – montres-bracelets et montre  
 Déposant: Montres Corum Sàrl, 1, rue du Petit-Château,  
 2300 La Chaux-de-Fonds  
 Designer: Severin Wunderman, Los Angeles  
 Mandataire: Inteltech SA, 2001 Neuchâtel  
 Fin de la période ajournement de la publication



1





2

Cl. 01-06 132 649 27.02.2006  
 4 Design – Tierfutter  
 Hinterleger: Heidi Weiss, Klosterrebenstrasse 4,  
 8918 Unterlunkhofen



Hundestrauss 1



Hundestrauss 2



Katzenstraus 2

Cl. 03-01 132 650 07.03.2006  
4 design – sacs  
Déposant: Nicolas Duborgel, chemin des Ouches 16,  
1203 Genève



pofscratch



Katzenstraus 1



oeuf



couenne



paden4



Tisch\_001



Cl. 06-03                      132 651                      22.02.2006  
2 Design – Tische  
Hinterleger: Renato Minacci, Aemtlerstrasse 90, 8003 Zürich



Tisch\_002

Cl. 06-04 132 652 24.02.2006  
 2 Design – Ablagemöbel  
 Hinterleger: punkt-s gmbh, Müllerstrasse 48, 8004 Zürich,  
 Designer: Beat Schöpfer, Zürich



S1\_002



S1\_019/020

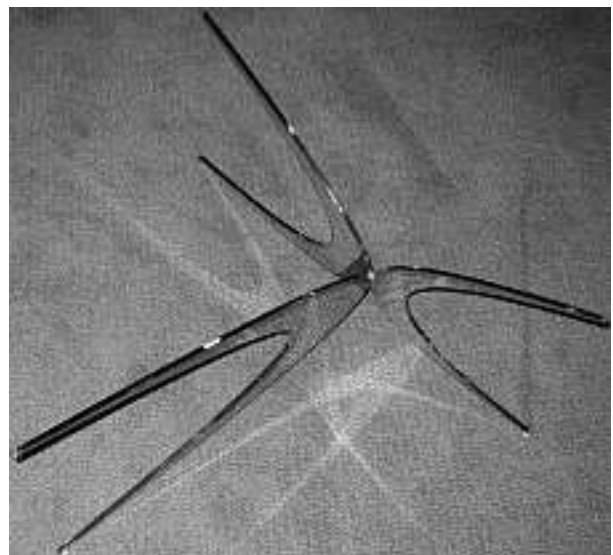
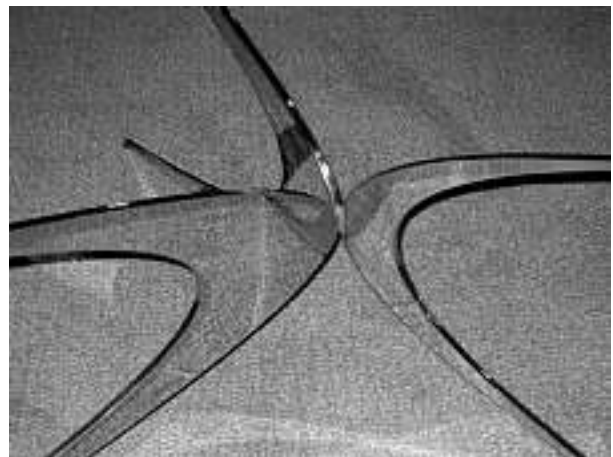
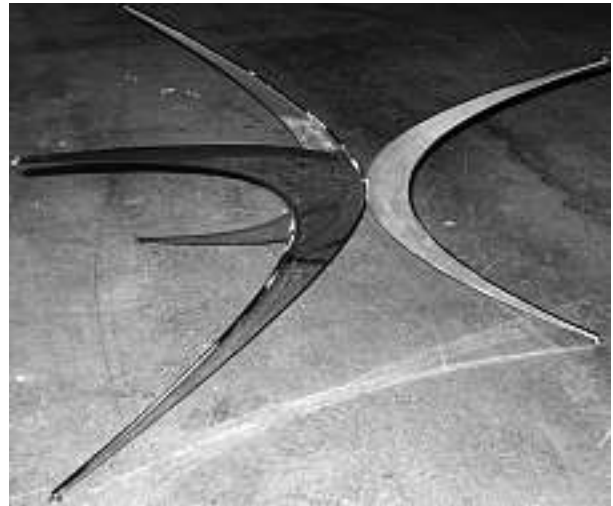

Parabelfuss1

Cl. 06-06 132 653 13.02.2006  
 1 Design – Tischfuss  
 Hinterleger: Urs R. Joss, Rotbergerstrasse 29, 4054 Basel

Cl. 07-01 132 654 08.03.2006  
 1 Design – Teller  
 Hinterleger: Kuhn Rikon AG, 8486 Rikon im Tösstal  
 Designer: Philipp Beyeler, Bern  
 Vertreter: Isler & Pedrazzini AG, 8023 Zürich

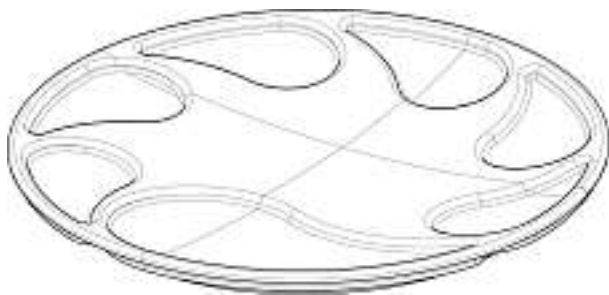
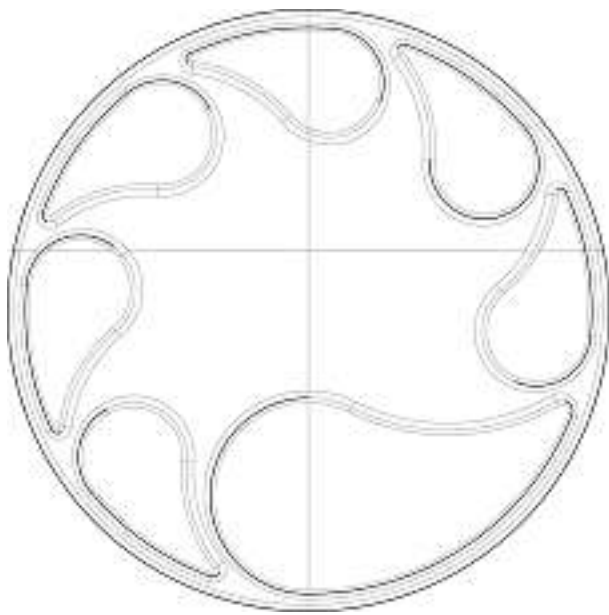

M13135

Cl. 07-99 132 655 06.03.2006  
 7 design – supports pour papier de ménage  
 Déposant: Cécile Lauper-Weick, 57, chem. Cannelet,  
 1285 Athenaz (Avusy)

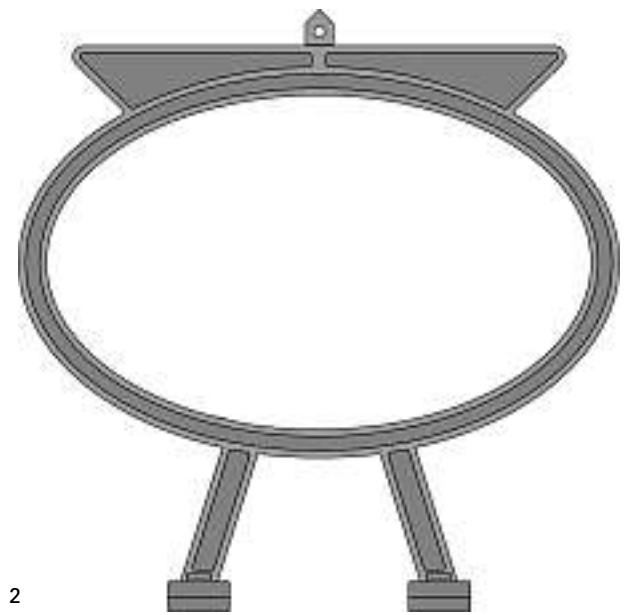

2

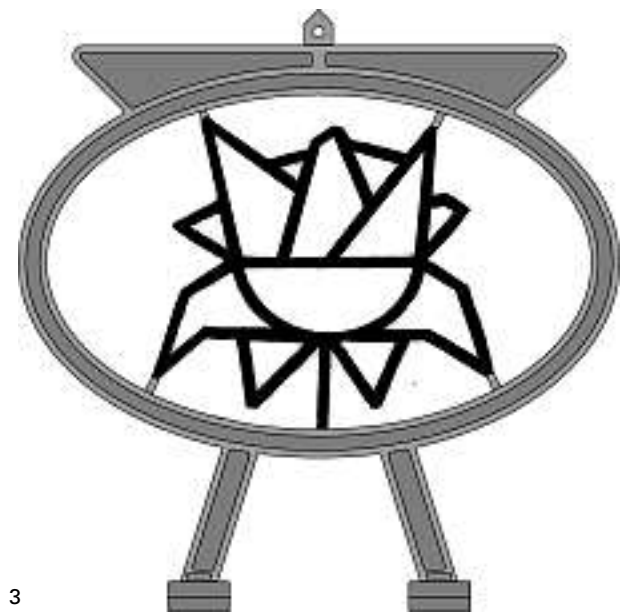

3

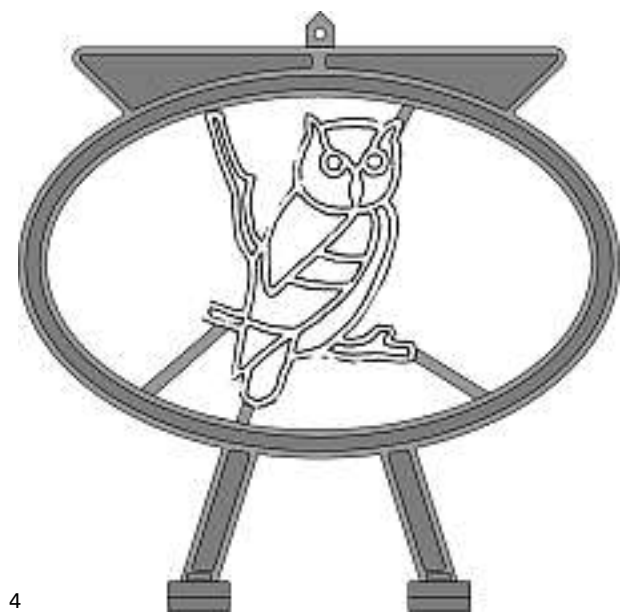

4

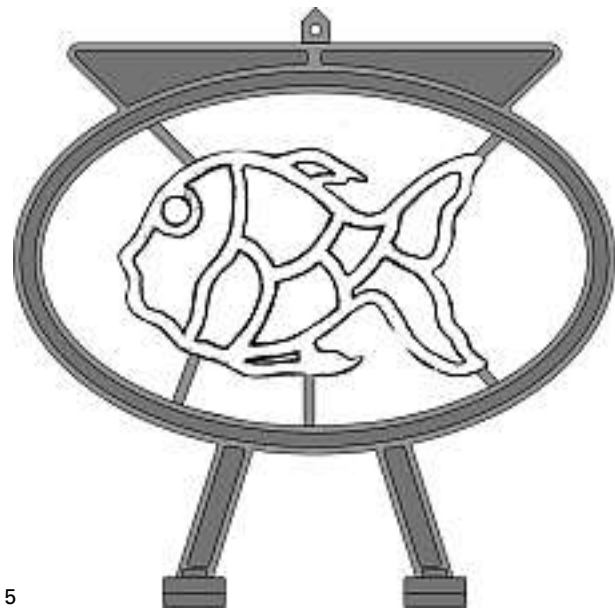

5

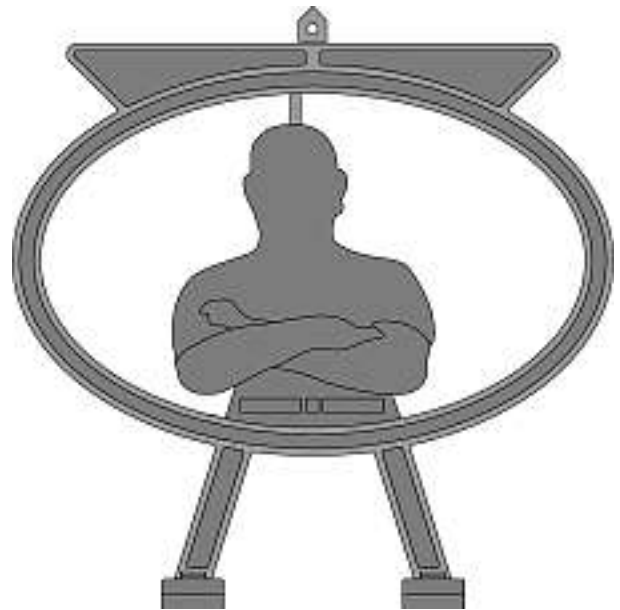

8

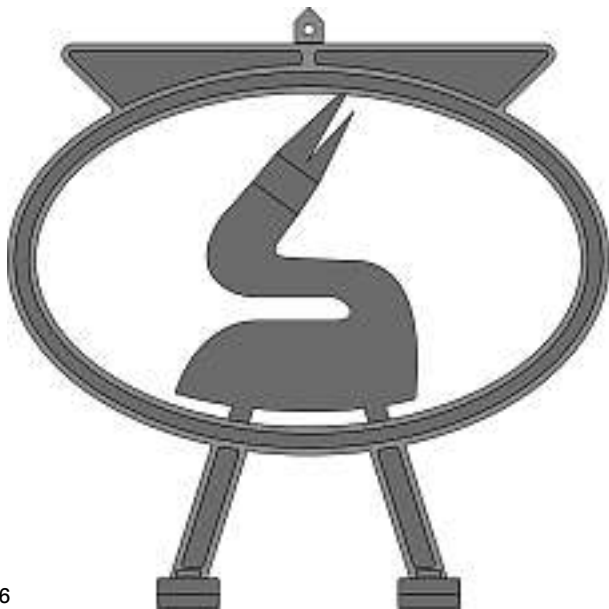

6

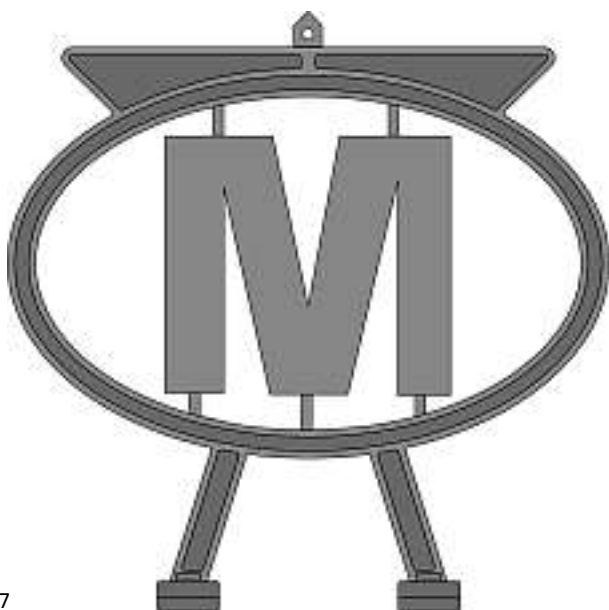

7

Cl. 08-06 **132 656** 08.03.2006  
 2 Design – Tür- und Fenstergriffe  
 Hinterleger: Hoppe AG, Jaufenstrasse 16,  
 St. Martin im Passeier, IT  
 Designer: Markus Raich, Moos im Passeier  
 Vertreter: PA Aldo Römpler, 9410 Heiden  
 Priorität: EM, 03.10.2005; EM, 03.10.2005

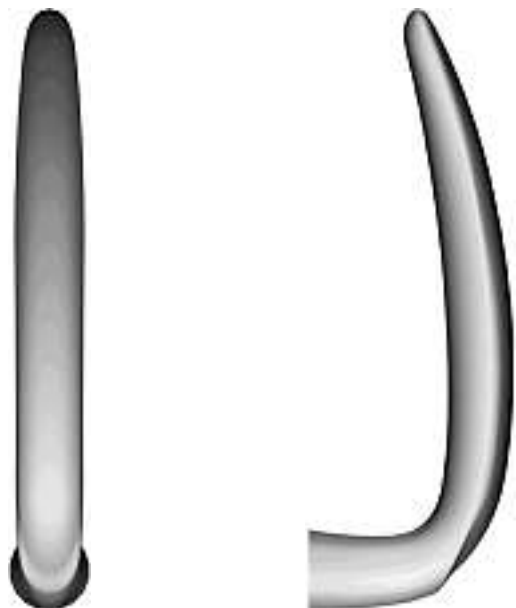

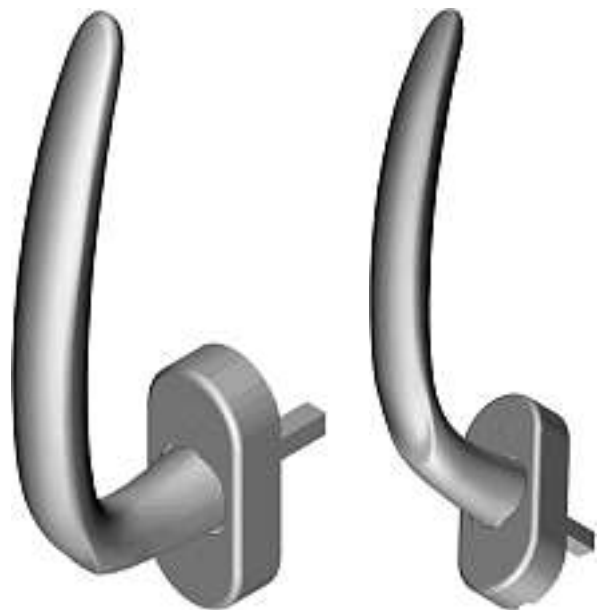
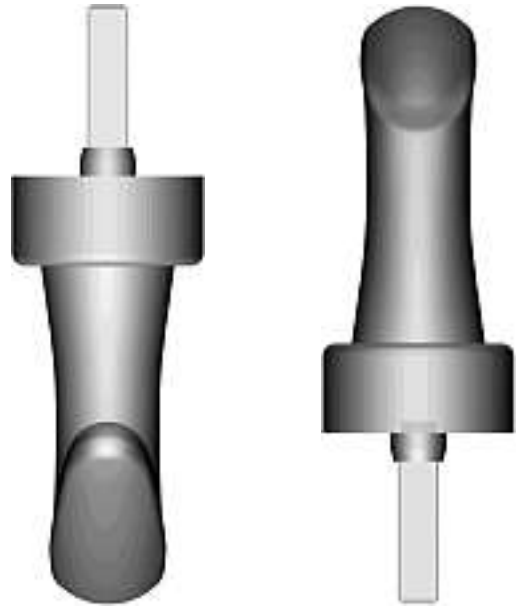
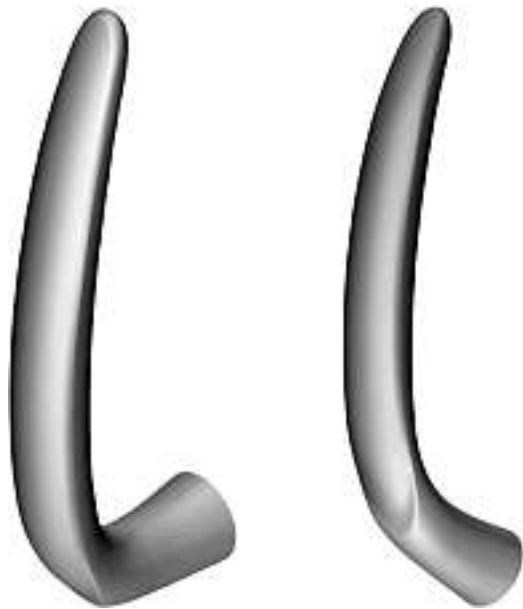
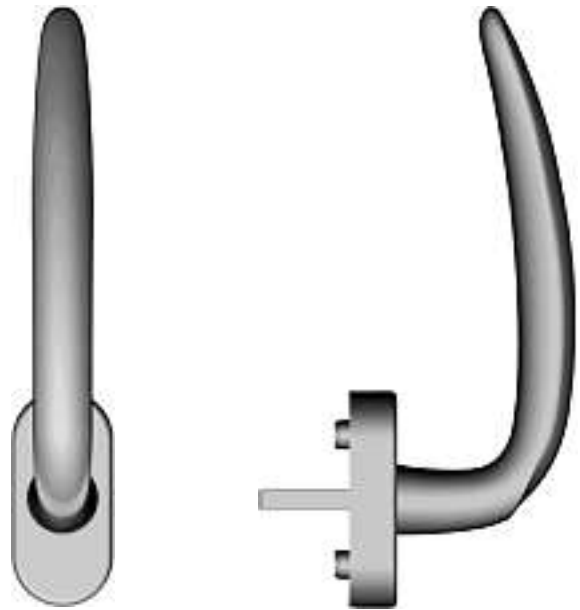
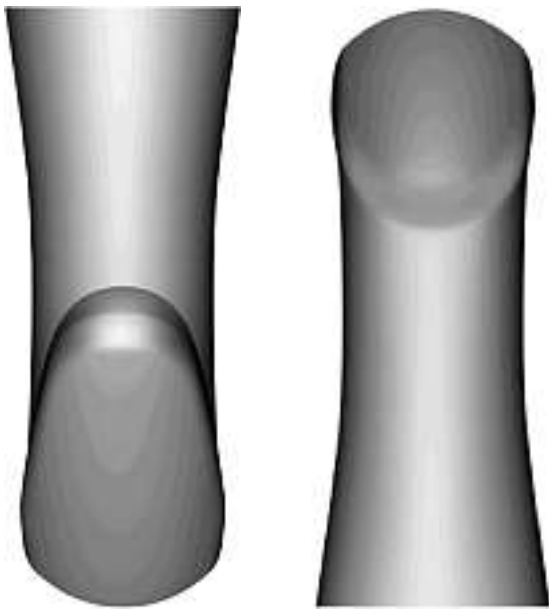



2

Cl. 08-07 132 657 06.03.2006  
 2 Design – Schlüssel  
 Hinterleger: INNOVA GmbH, An der Vogelrute 32, Ascheberg-Herbern, DE  
 Designer: Josef Krampe, Ascheberg-Herbern  
 Vertreter: Isler & Pedrazzini AG, 8023 Zürich  
 Priorität: DE, 08.09.2005



M13117-1



M13117-2

Cl. 08-09 132 658 07.03.2006  
 5 Design – Möbelbeschläge  
 Hinterleger: Hettich-ONI GmbH & Co. KG, Industriestrasse 11-13, Vlotho, DE  
 Designer: Heinrich Hensler, Schwäbisch Gmünd; Martin Schultheiss, Schwäbisch Gmünd  
 Vertreter: Dr. Thomas Stephan, 8400 Winterthur  
 Priorität: EM, 16.09.2005; EM, 16.09.2005; EM, 16.09.2005; EM, 16.09.2005; EM, 16.09.2005

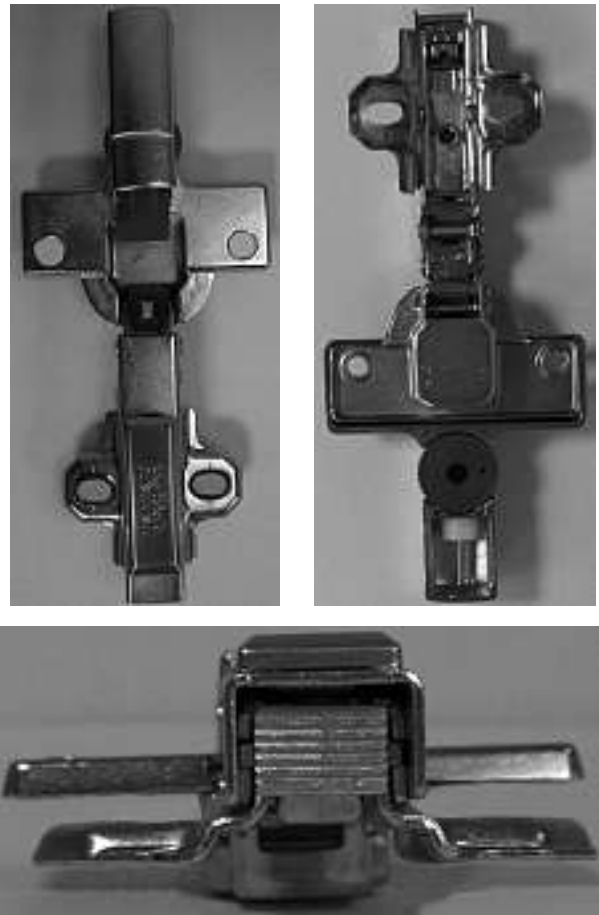



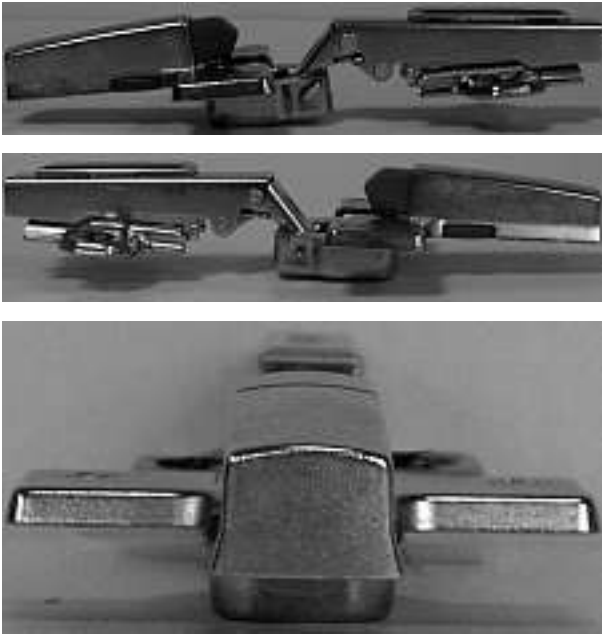

0001

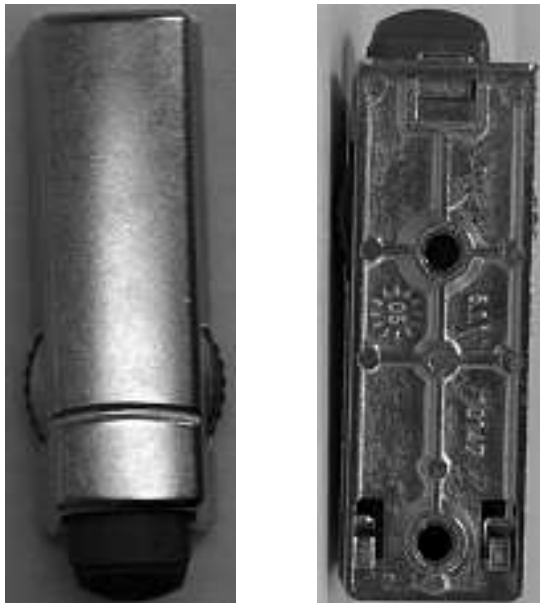

0002



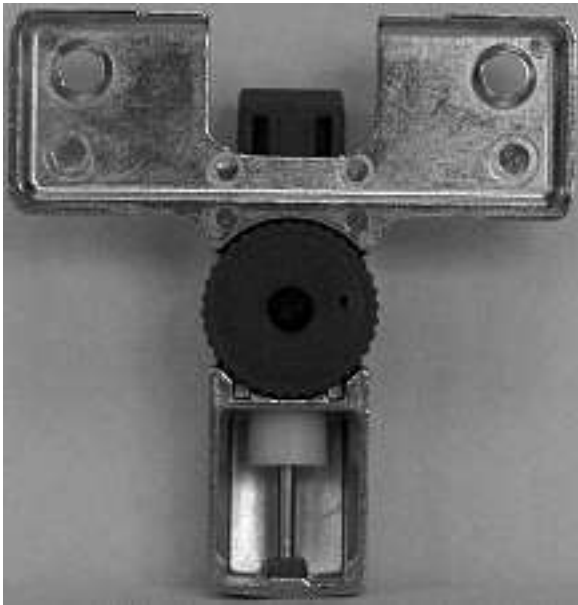

0003

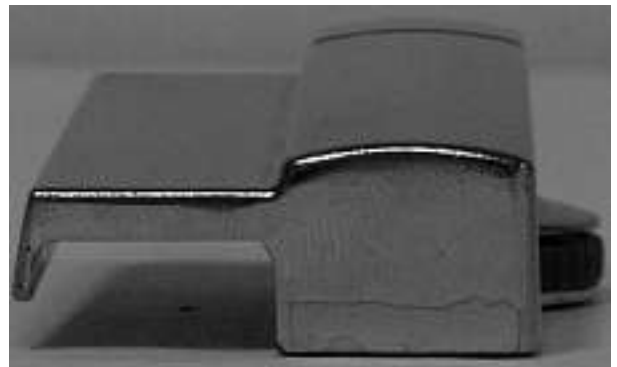



0004

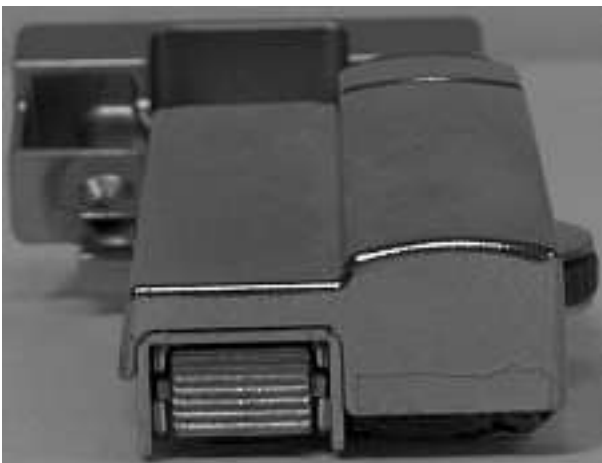

0005

Cl. 09-01 132 659 16.02.2006

1 Design – Flasche

Hinterleger: Landau Naturkosmetik e.K.,  
Johann-Christoph-Hilf-Strasse 3, Bad Elster (Vogtland), DE

Designer: Tino Alferi, Halle

Vertreter: Friederike Landau, 8272 Ermatingen





Kickermann-Flasche

Cl. 09-03 132 660 08.02.2006  
 2 Design – Faltschachteln  
 Hinterleger: K+D AG, Schuppisstrasse 8, 9016 St. Gallen  
 Designer: Mark Sutter, St. Gallen

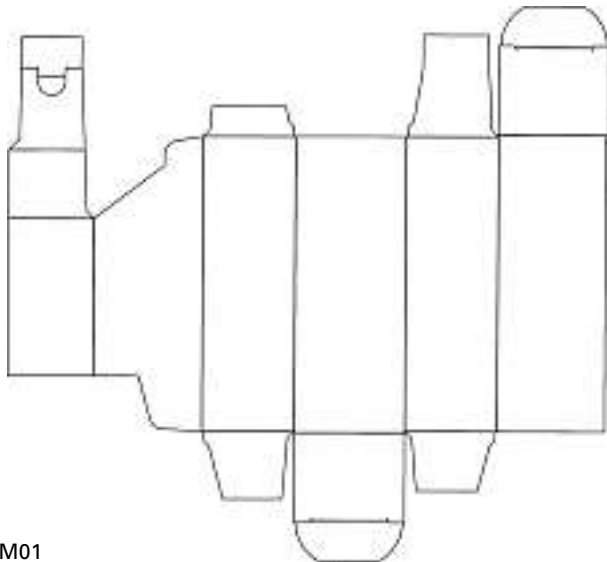

M01

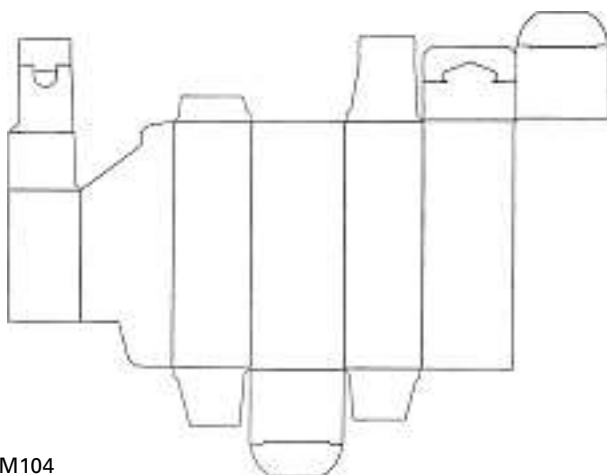

M104

Cl. 10-02 132 661 28.03.2006  
 2 design – montres-bracelets  
 Déposant: The British Masters SA, Avenue Léopold-Robert  
 23, 2300 La Chaux-de-Fonds  
 Designer: Eric A. Loth, La Chaux-de-Fonds  
 Mandataire: Inteltech SA, 2001 Neuchâtel





1





2

Cl. 10-02 132 662 29.03.2006  
4 design – montres-bracelets  
Déposant: Daniel Roth et Gérald Genta Haute Horlogerie SA,  
Chemin du Grand-Puits 42, 1217 Meyrin  
Designer: Jean-Marc Salemi, Morges  
Mandataire: Inteltech SA, 2001 Neuchâtel



1





2



3





4

Cl. 10-07 **132 663** 08.03.2006  
 2 design – bracelets et maillons de bracelets de montres  
 Déposant: Hartcase Corporation, 2500 Westchester Avenue,  
 Suite 103, Purchase / NY, US  
 Designer: Paul Hartzband, Chappaqua  
 Mandataire: INFOSUISSE, Information Horlogère et  
 Industrielle, 2302 La Chaux-de-Fonds

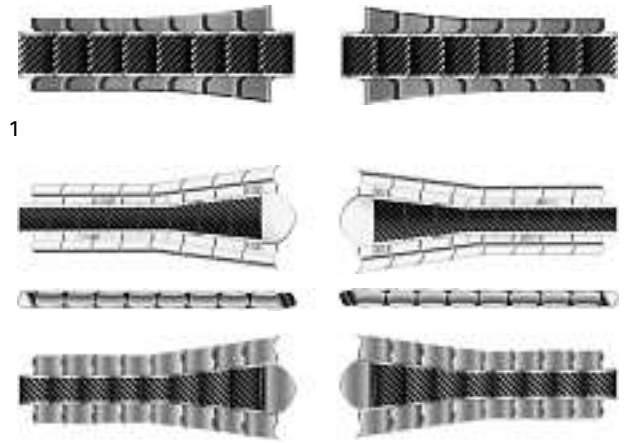
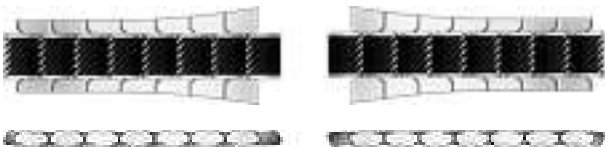

1

2

Cl. 10-07 **132 664** 16.03.2006  
 32 design – cadrans, boîtes de montres  
 Déposant: Montres Choisi Sàrl, 19, rue du Faucon,  
 2500 Bienne  
 Designer: Jean-Pierre Duss, Bienne  
 Mandataire: Cabinet Roland Nithardt, Conseils en Propriété  
 Industrielle SA, 1400 Yverdon-les-Bains

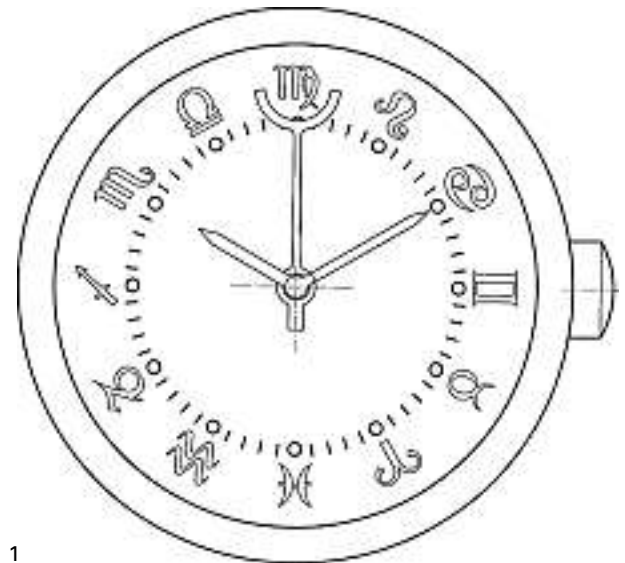

1

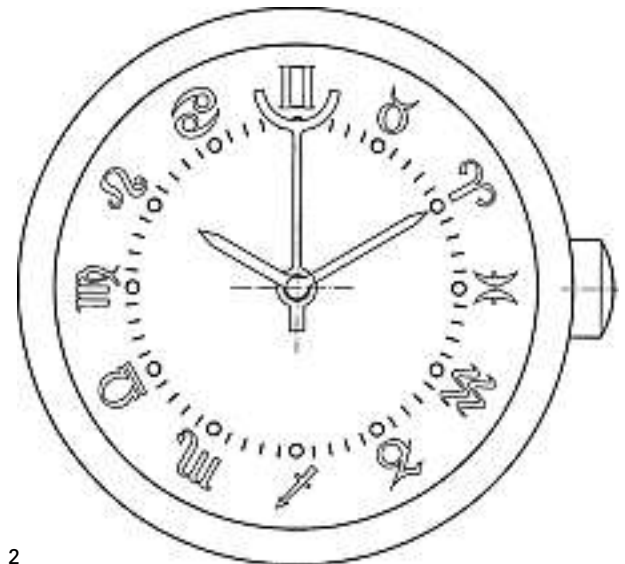

2



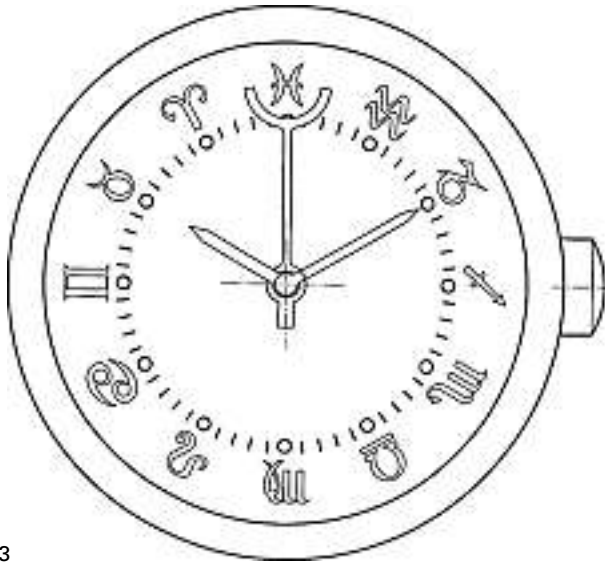

3

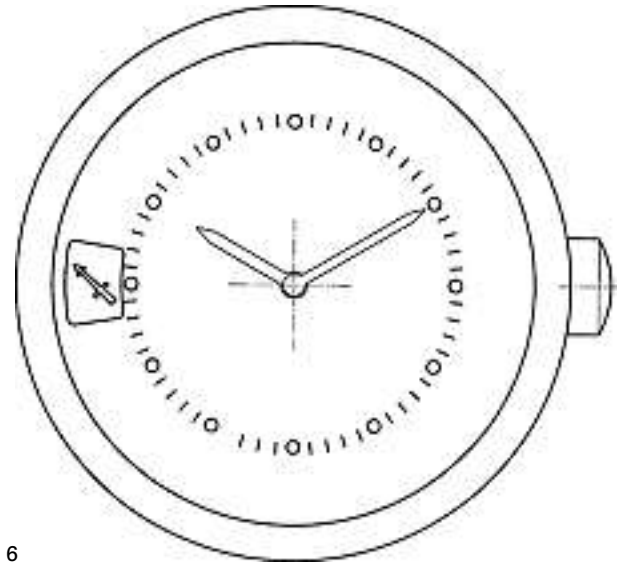

6

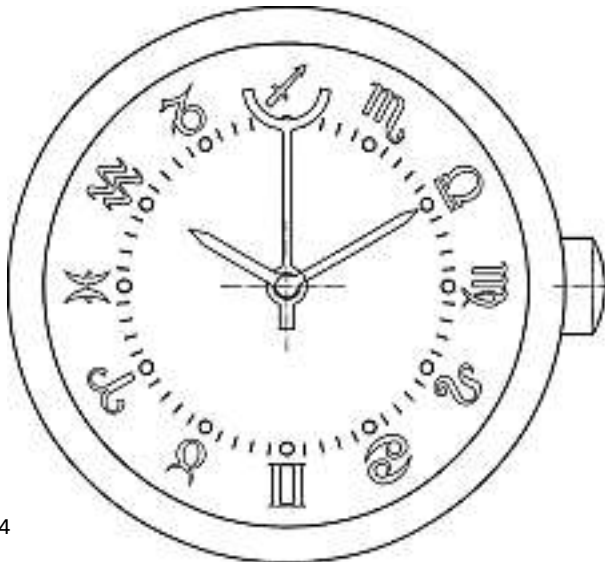

4

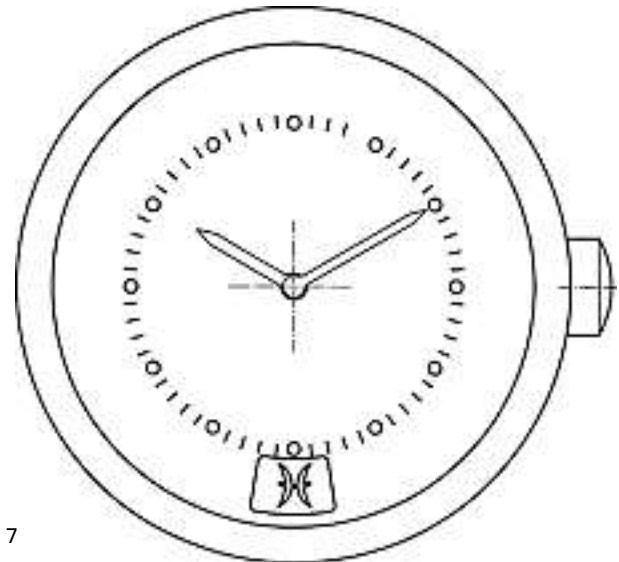

7

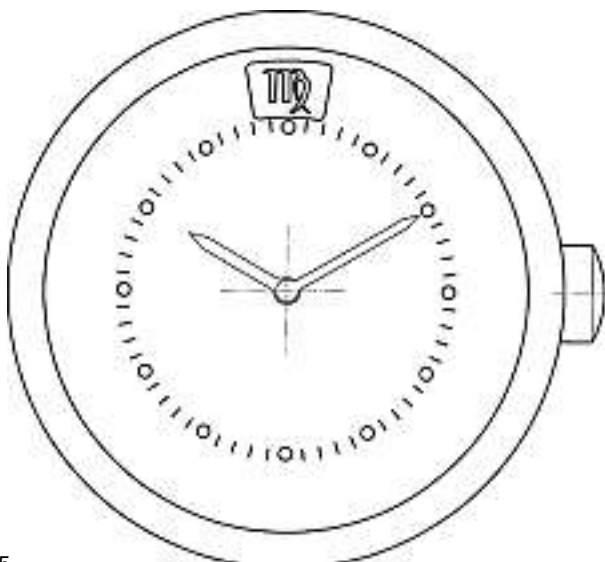

5

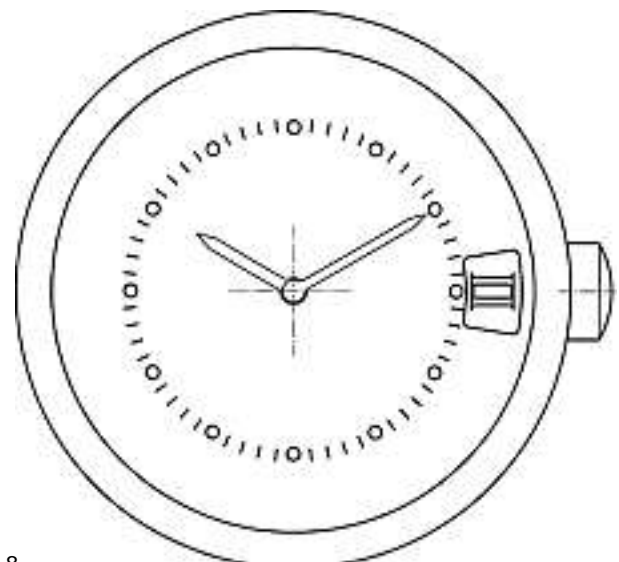

8

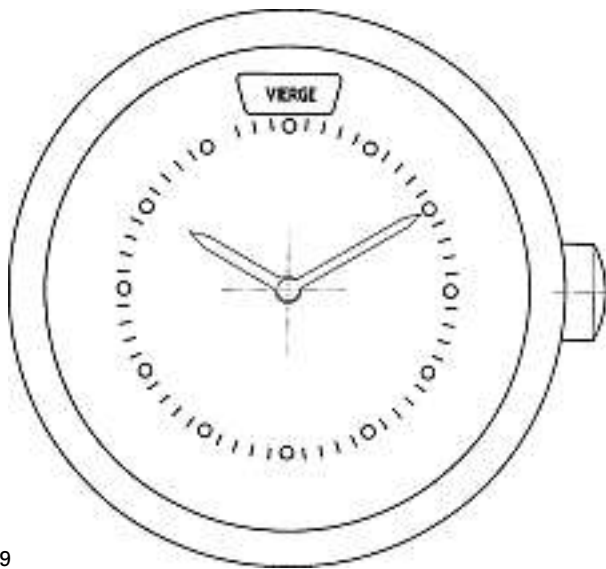

9

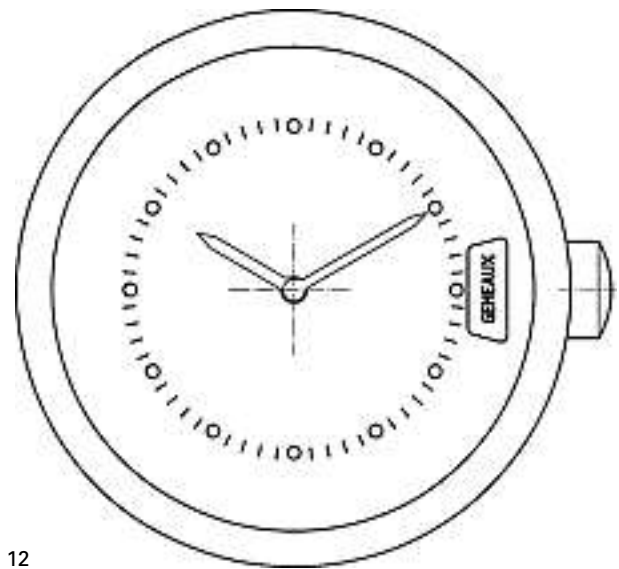

12

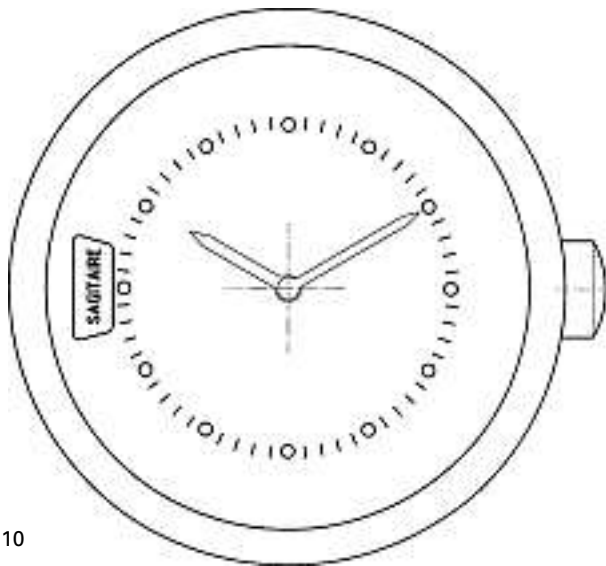

10

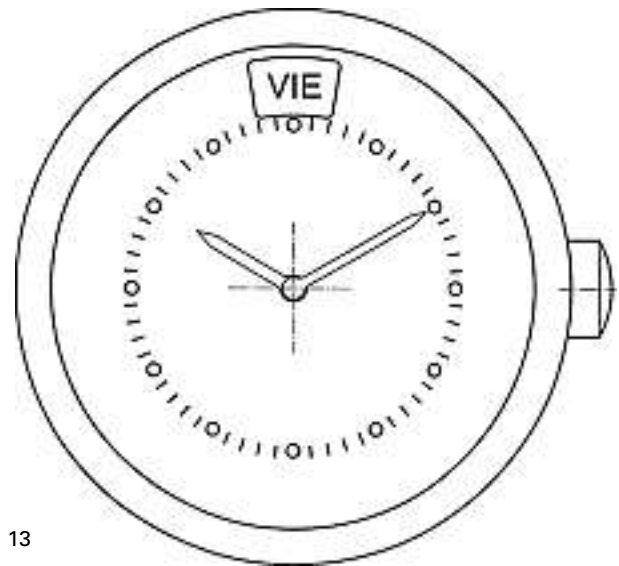

13

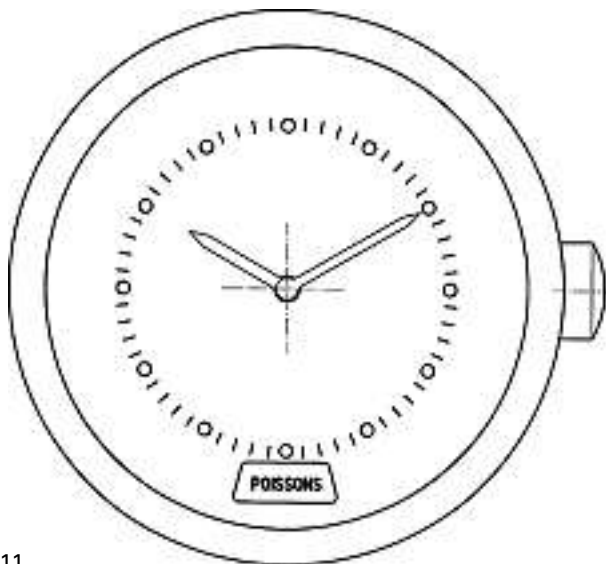

11

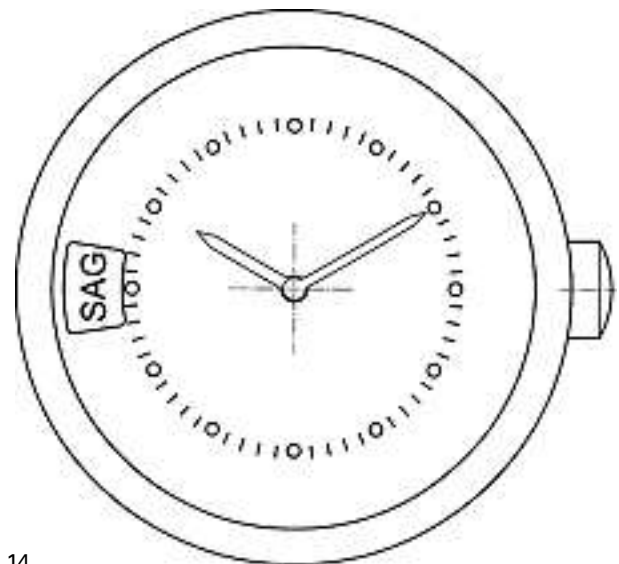

14

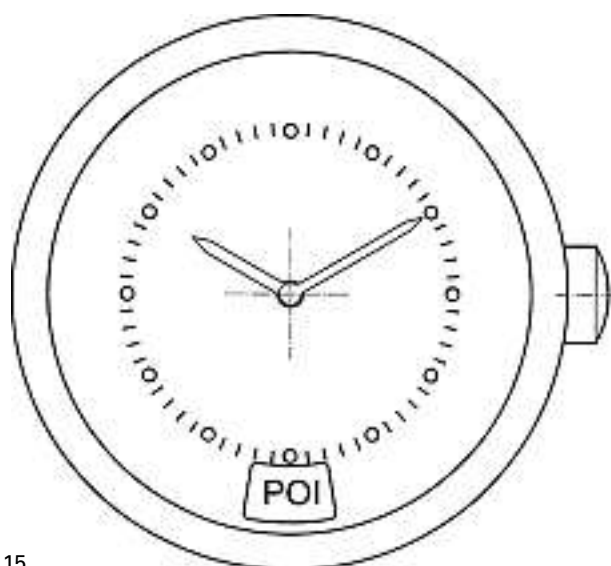

15

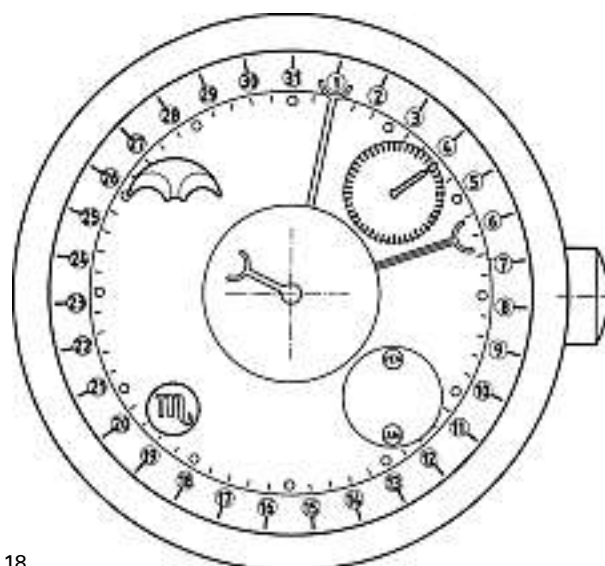

18

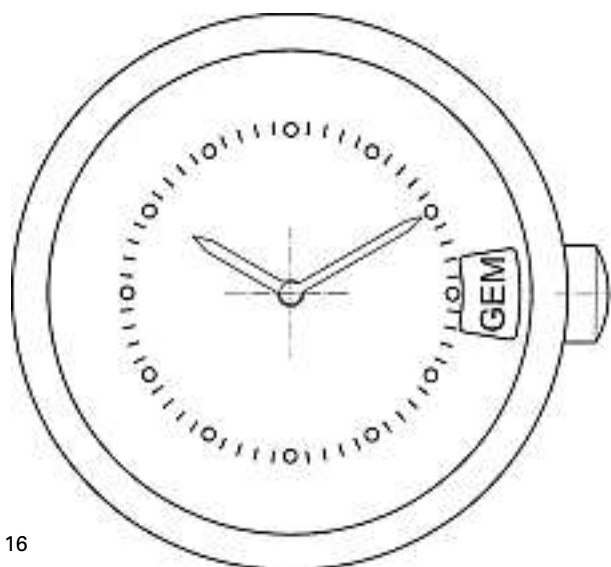

16

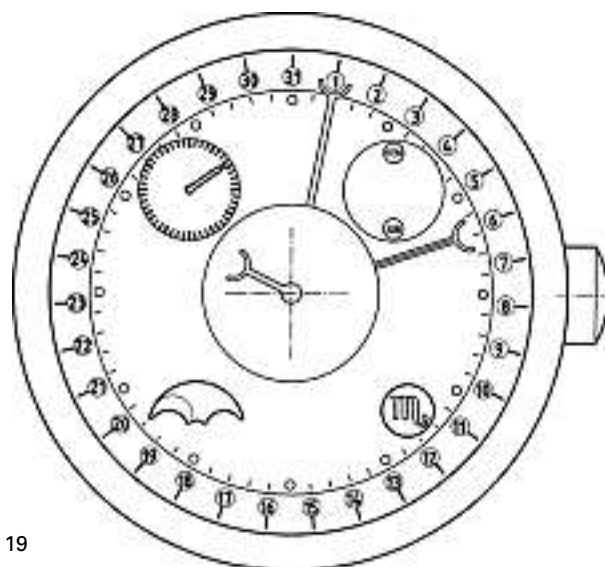

19

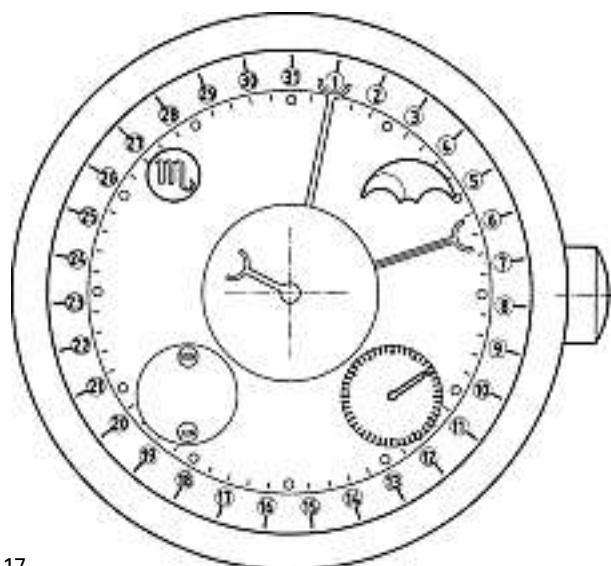

17

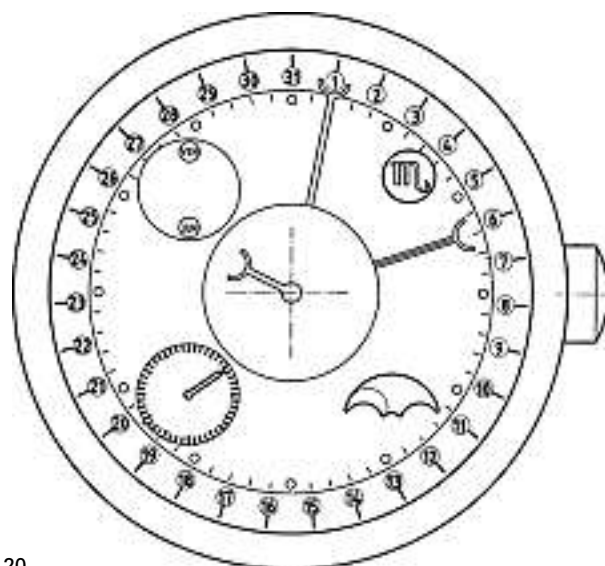

20

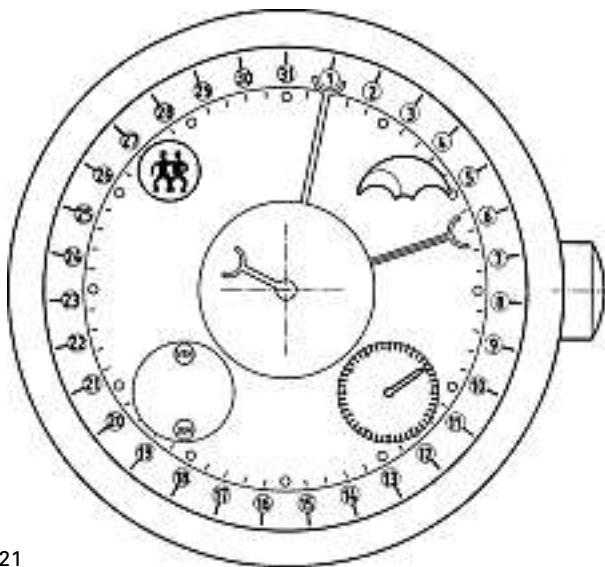

21

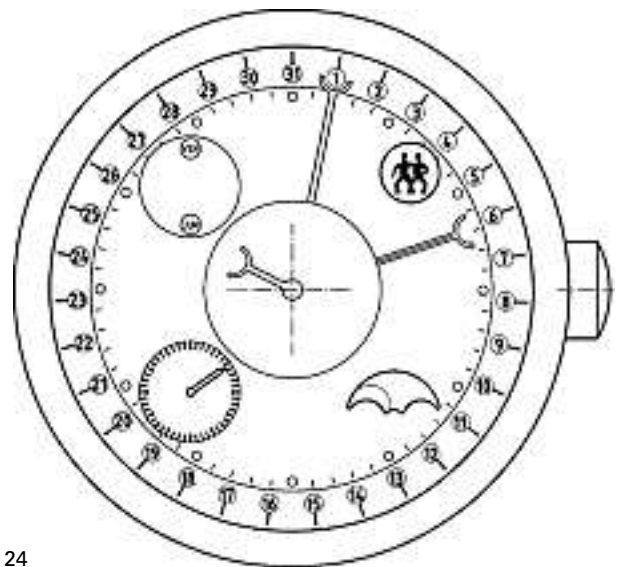

24

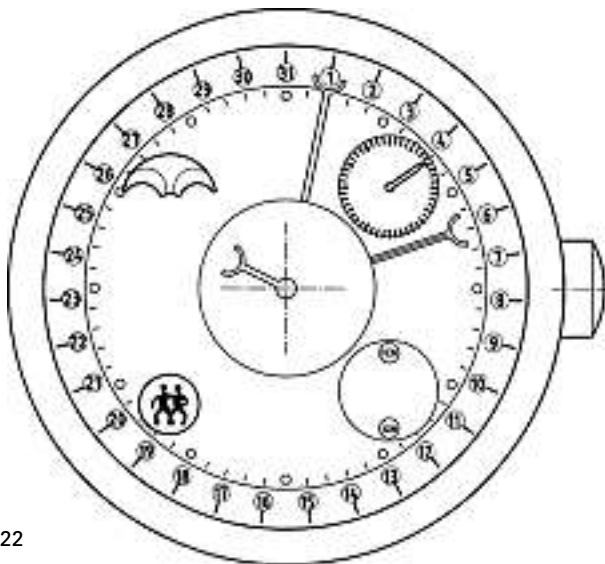

22

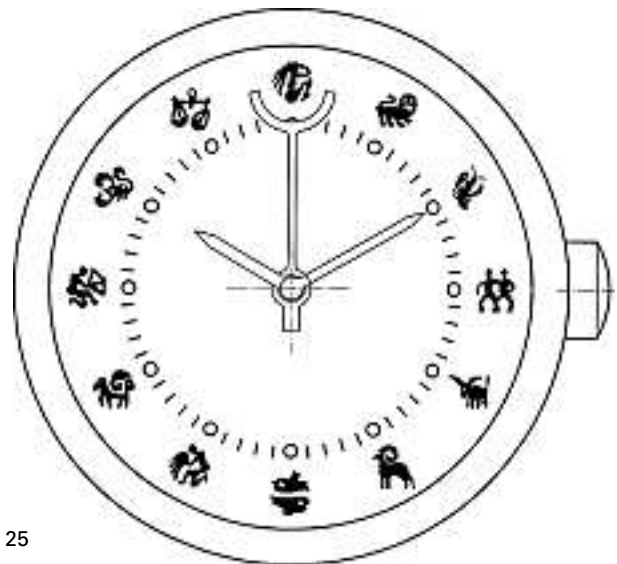

25

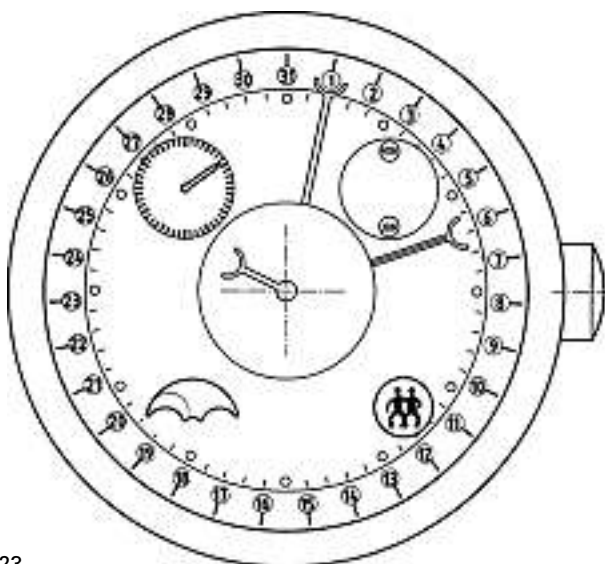

23



26

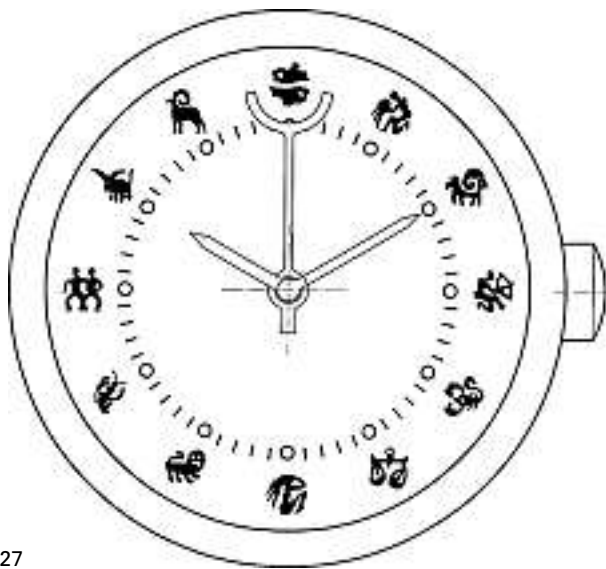

27

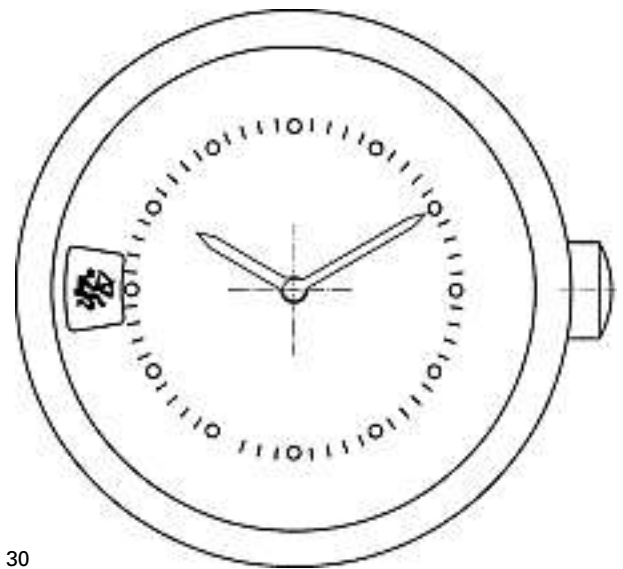

30

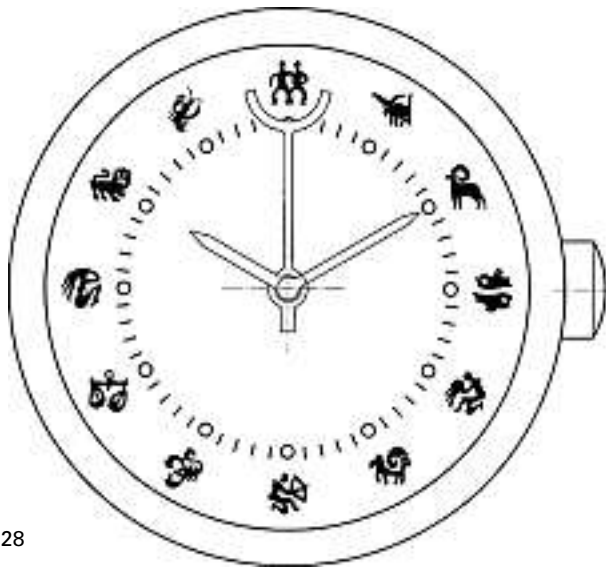

28

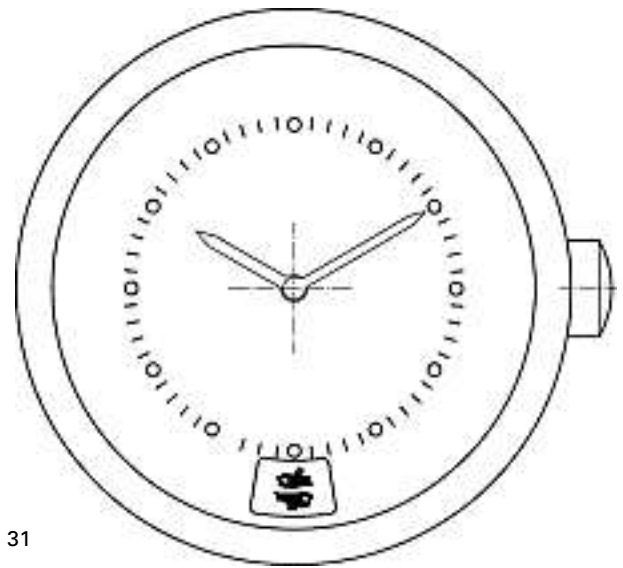

31

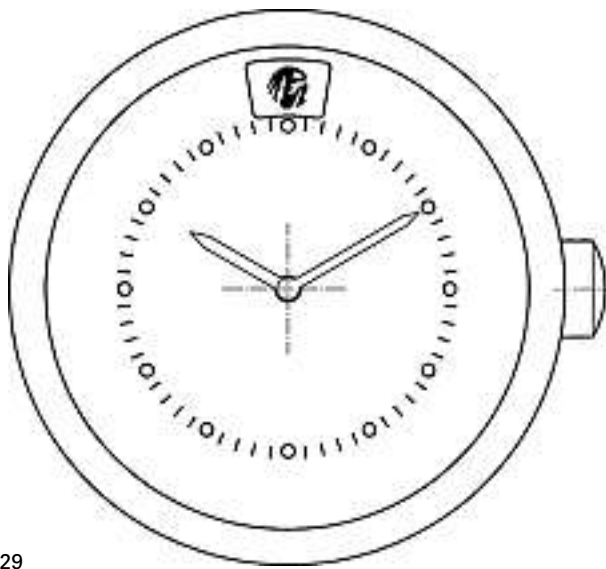

29

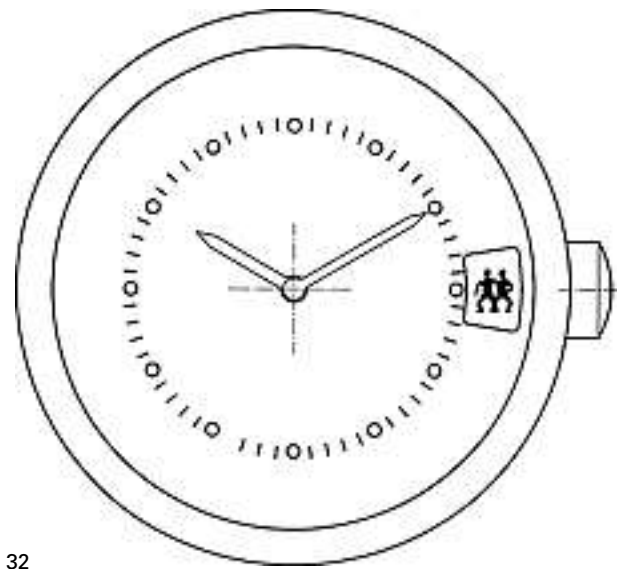

32

Cl. 11-02 132 667 20.02.2006  
 1 Design – Vase  
 Hinterleger: Markus Moser, Hütten / Reutenen, 3532 Zäziwil

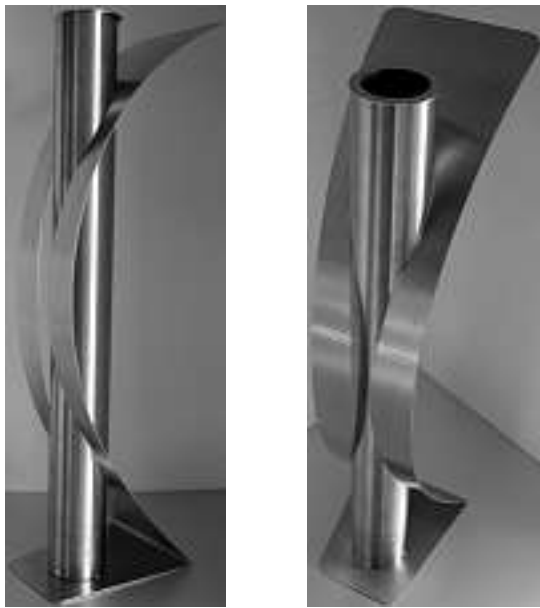

10-Nobel-Rohr

Cl. 11-02 132 668 27.02.2006  
 1 Design – Ziergegenstand  
 Hinterleger: Roman Schneider, Sechskrügelgasse 2 b, Wien, AT; Elisabeth Schneider, Sechskrügelgasse 2 b, Wien, AT  
 Vertreter: Gertrude Hogg, 8038 Zürich



1

Cl. 12-16 132 669 16.02.2006  
 7 design – pare-brise pour bus; lunette-arrière pour bus;  
 pare-chocs pour bus  
 Déposant: Heuliez Bus S.A., La Crénuère, Rorthais, FR  
 Designer: Antoine Garnier, Maulevrier  
 Mandataire: Schmauder & Partner AG, Patentanwälte VSP,  
 8038 Zürich  
 Priorité: EM, 20.01.2006



1



2





3

4

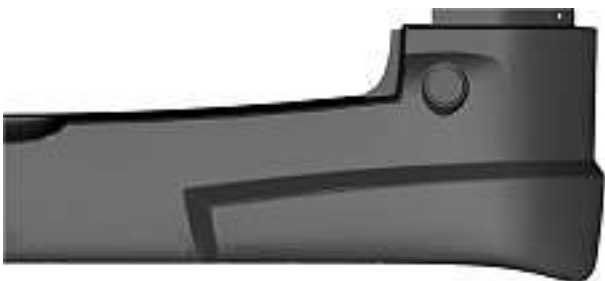



5







6

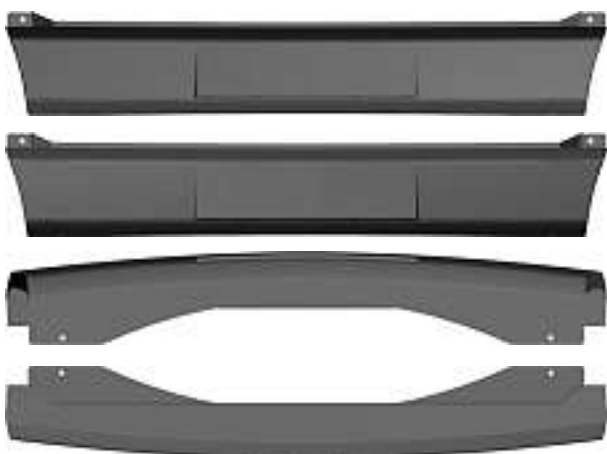

7



Cl. 14-01 **132 670** 02.03.2006  
 1 Design – MP3-Abspielgerät  
 Hinterleger: Medion AG, Gänsemarkt 16-18, 45127 Essen, DE  
 Designer: Bernhard Geisen, Mülheim an der Ruhr  
 Vertreter: Hans Rudolf Gachnang, Patentanwalt,  
 8501 Frauenfeld  
 Priorität: EM, 05.09.2005





1

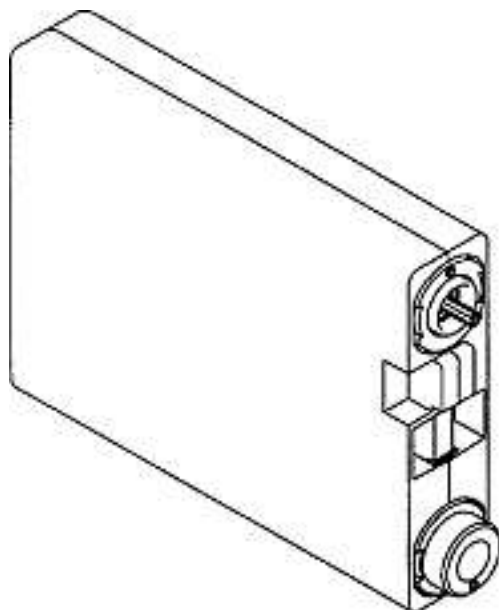
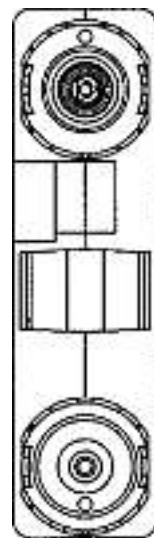
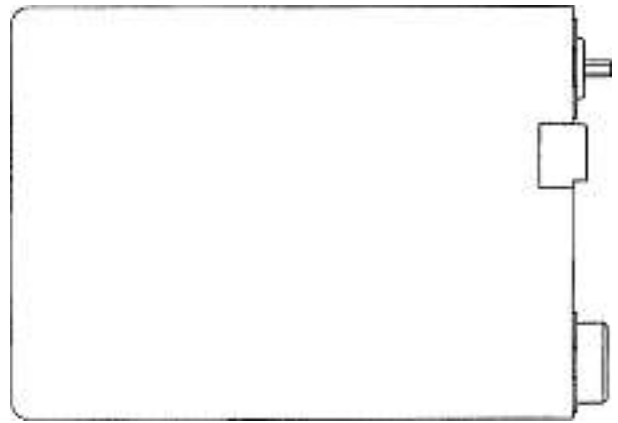

Cl. 14-02                      **132 671**                      20.03.2006  
 4 Design – Tintenkassette  
 Hinterleger: Brother Industries, Ltd, 15-1, Naeshiro-cho,  
 Mizuho-ku, Nagoya-shi / Aichi-ken, JP  
 Designer: Shingo Hattori, Nagoya; Toyonori Sasaki, Nagoya;  
 Tomohiro Kanbe, Nagoya  
 Vertreter: E. Blum & Co., 8044 Zürich  
 Priorität: JP, 18.11.2005

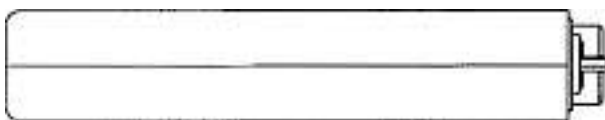

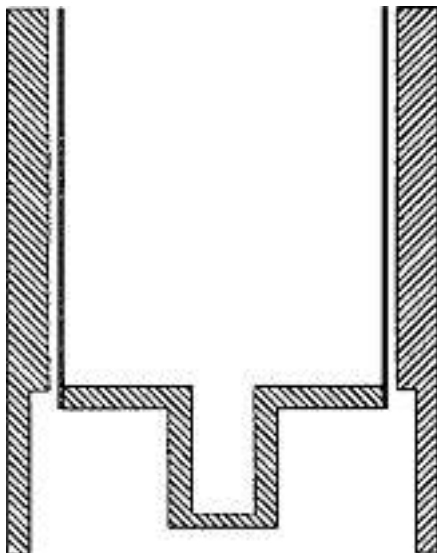
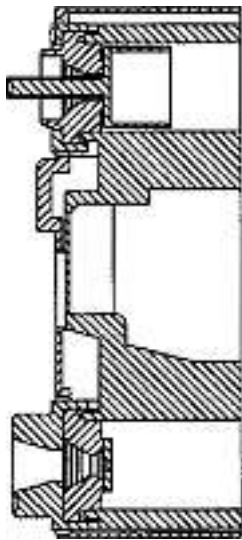

a

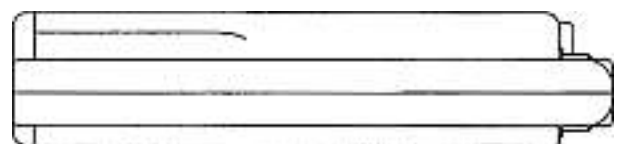
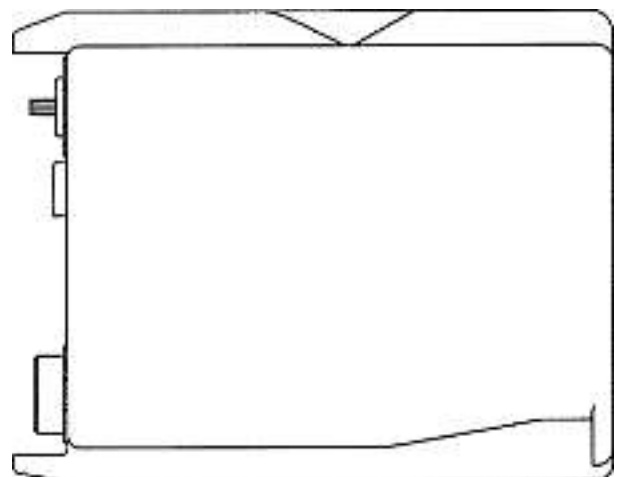
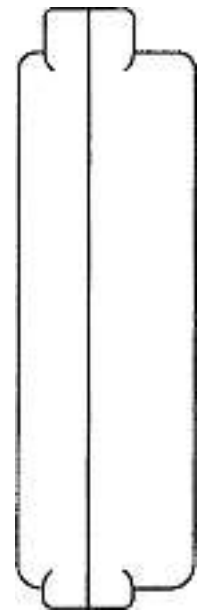
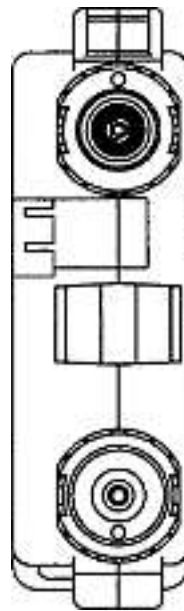
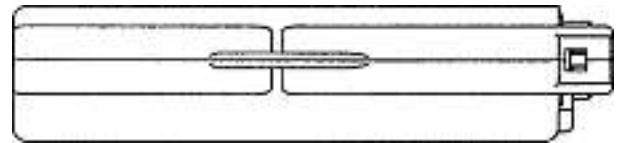
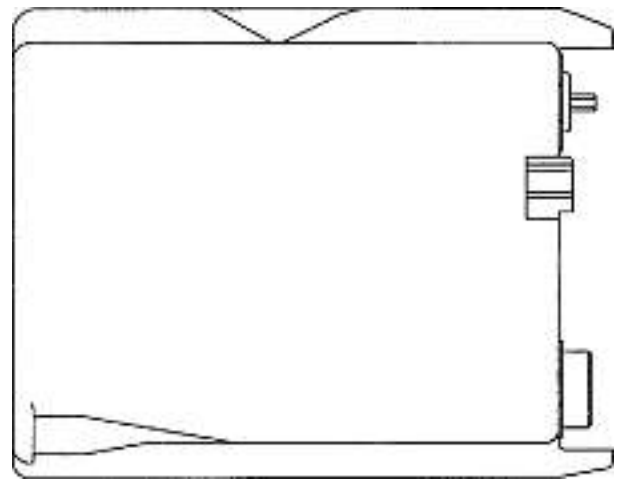

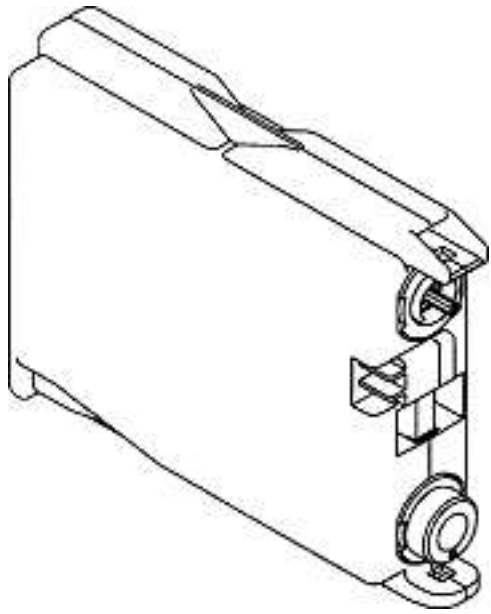

b

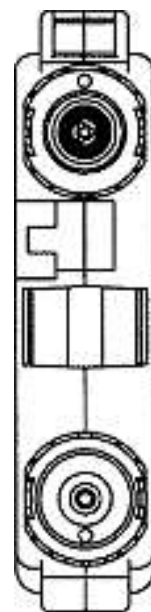
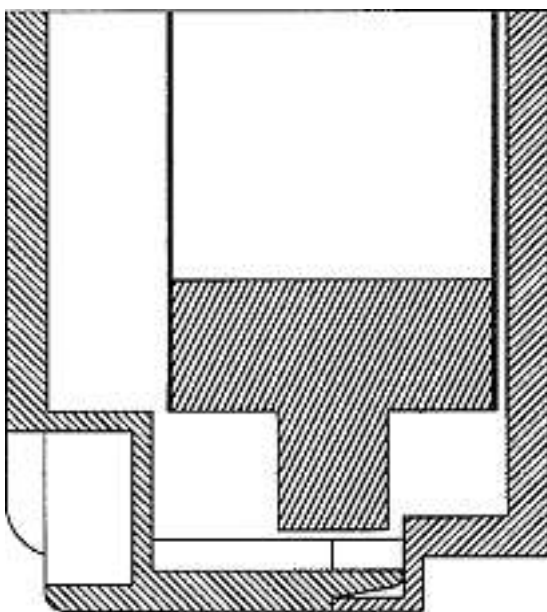
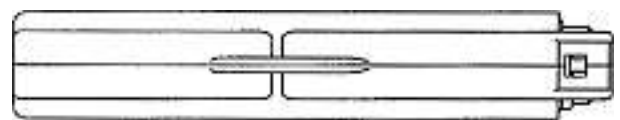
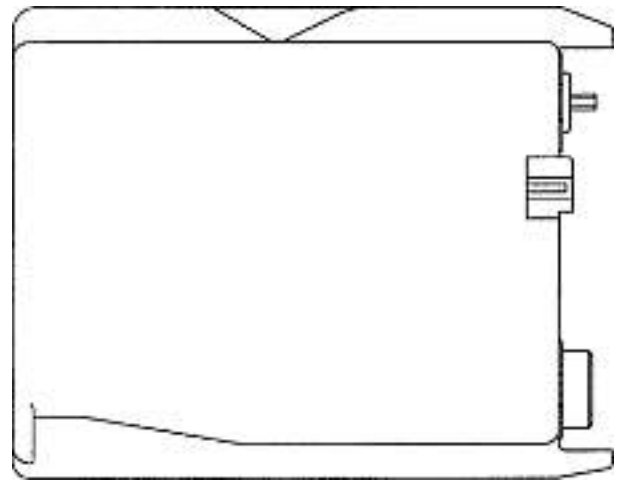
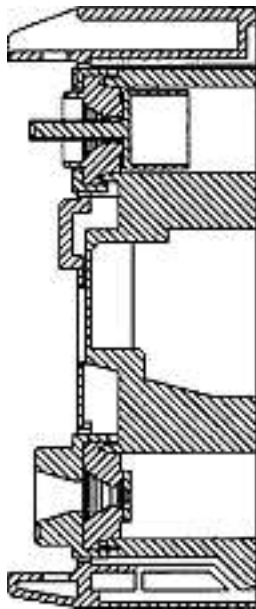
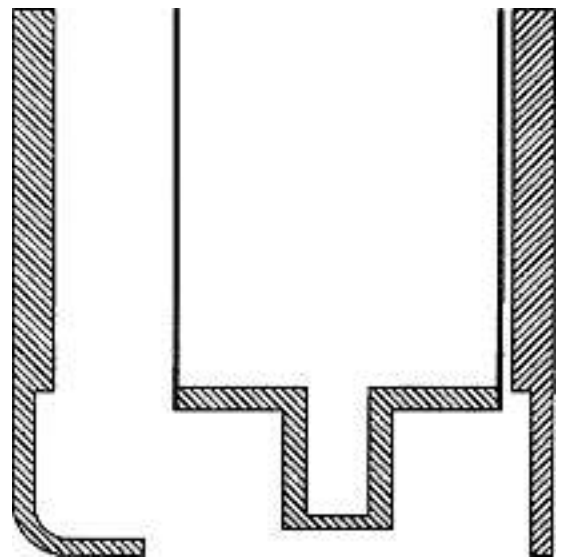

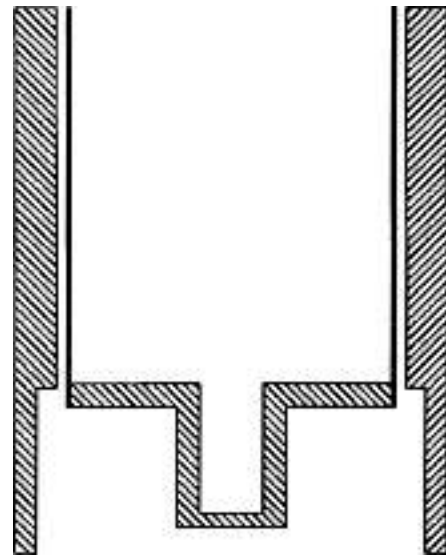
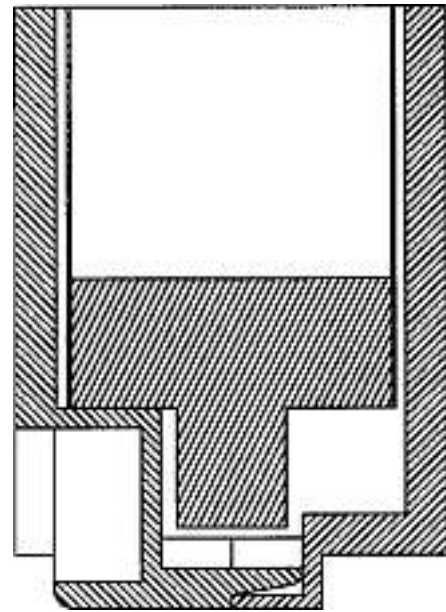
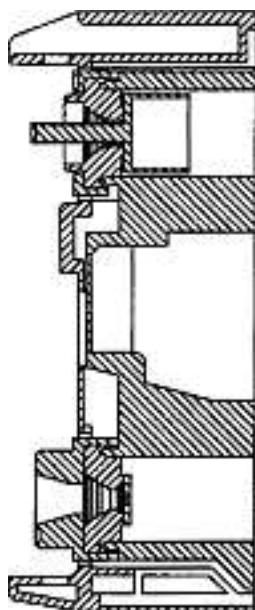
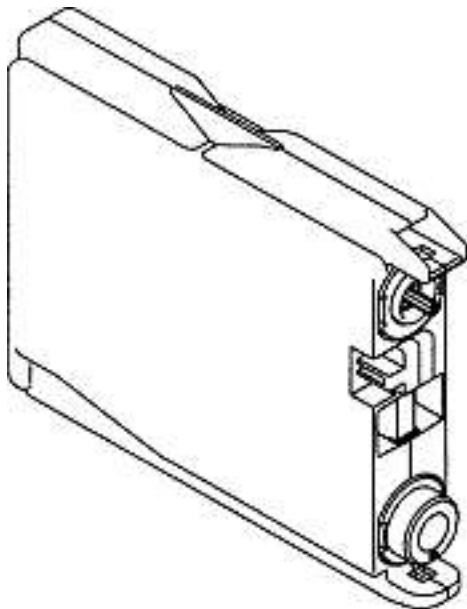
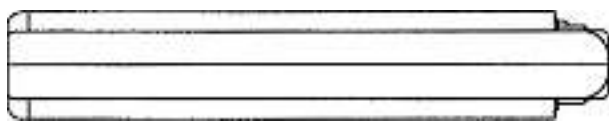
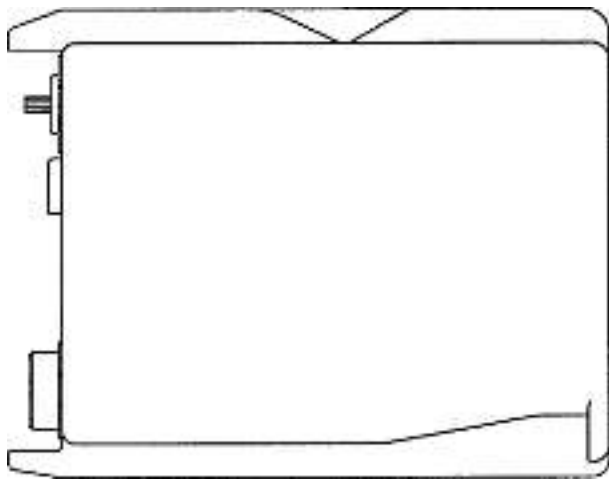

c

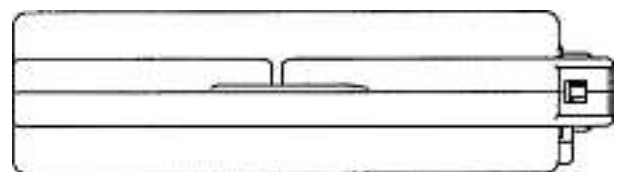
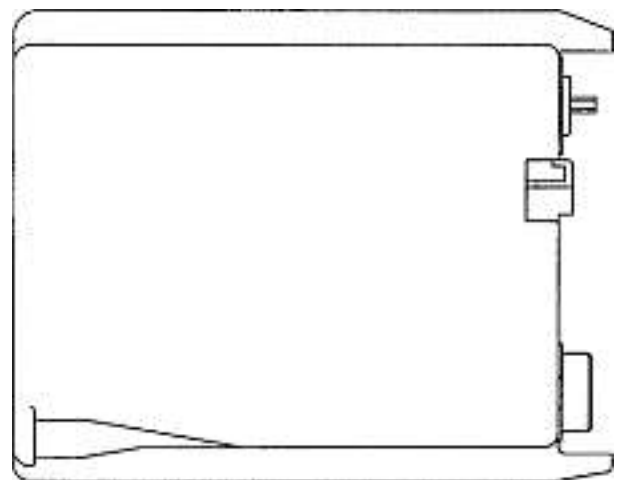

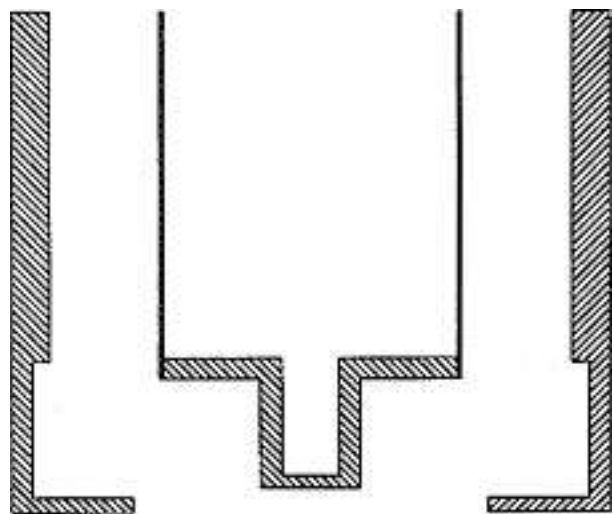
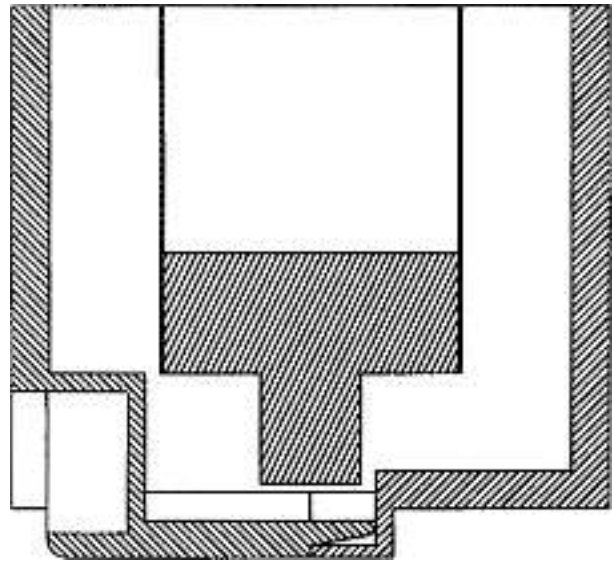
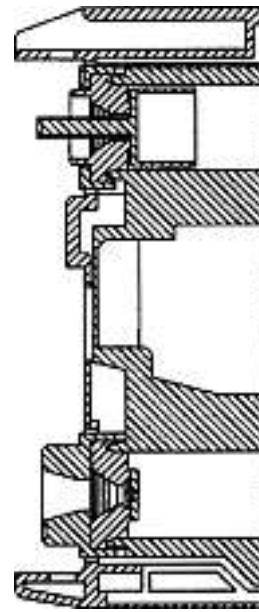
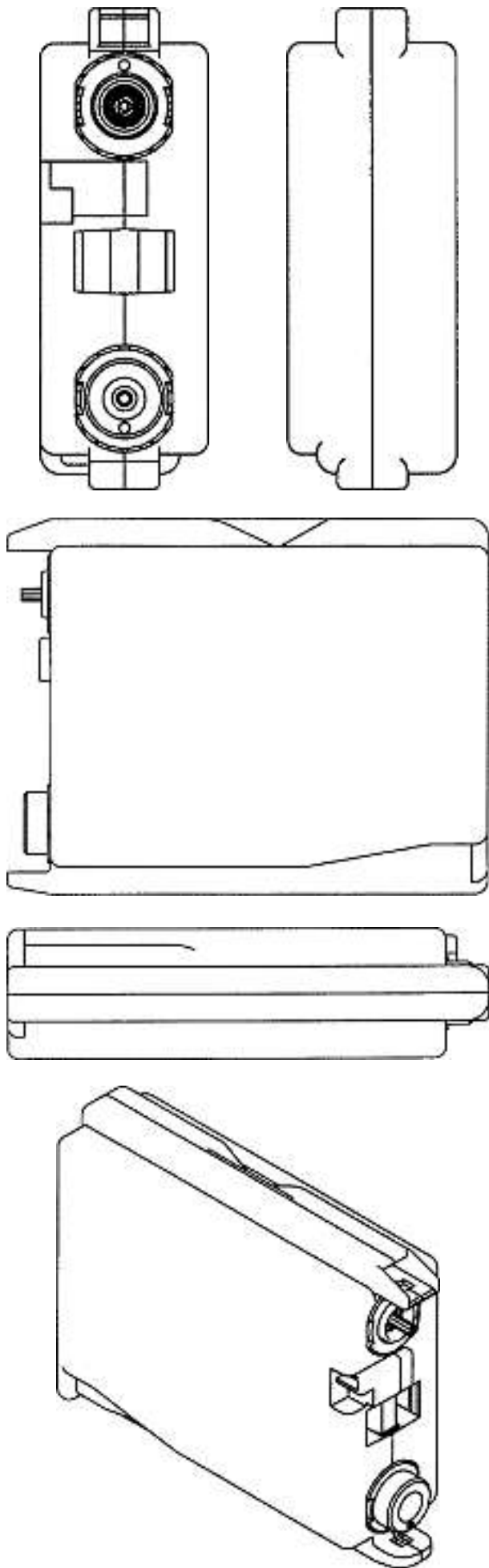

d

Cl. 19-08 132 672 25.01.2006  
1 Design – Druckvorlage  
Hinterleger: Wetrok AG, Steinackerstrasse 62, 8302 Kloten  
Designer: Michael Thurnheer, Rapperswil



Power-shot

Cl. 21-01 132 673 18.02.2006  
 2 Design – Spielstein  
 Hinterleger: Daniel Wepfer, Wellhauserweg 48,  
 8500 Frauenfeld

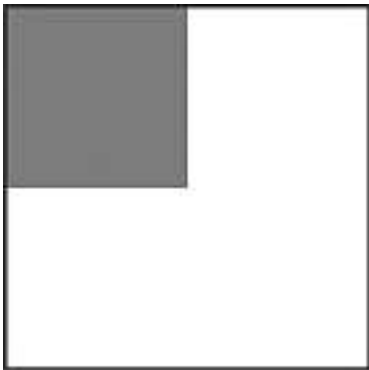

1. Spielstein

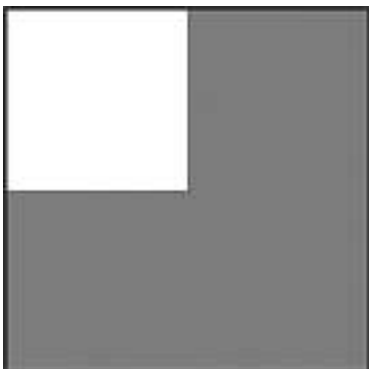

2. Spielstein

Cl. 21-01 132 674 23.02.2006  
 2 Design – Kugelspiel und Teile davon  
 Hinterleger: Rolf Rütter, Haselholzweg 24,  
 3098 Schliern b. Köniz



Minava 1

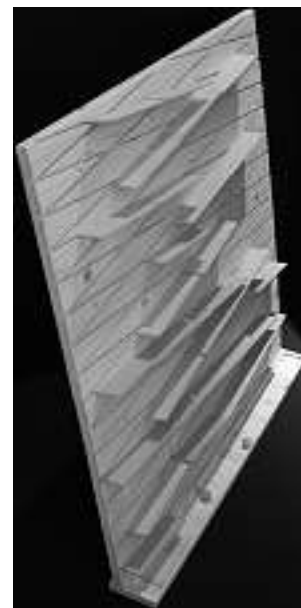

Minava 2

Cl. 21-02 132 675 02.03.2006  
 2 Design – Stockgriffe  
 Hinterleger: Lekisport AG, Lindenstrasse 8, 6340 Baar  
 Designer: Klaus Lenhart, Ohmden  
 Vertreter: Isler & Pedrazzini AG, 8023 Zürich

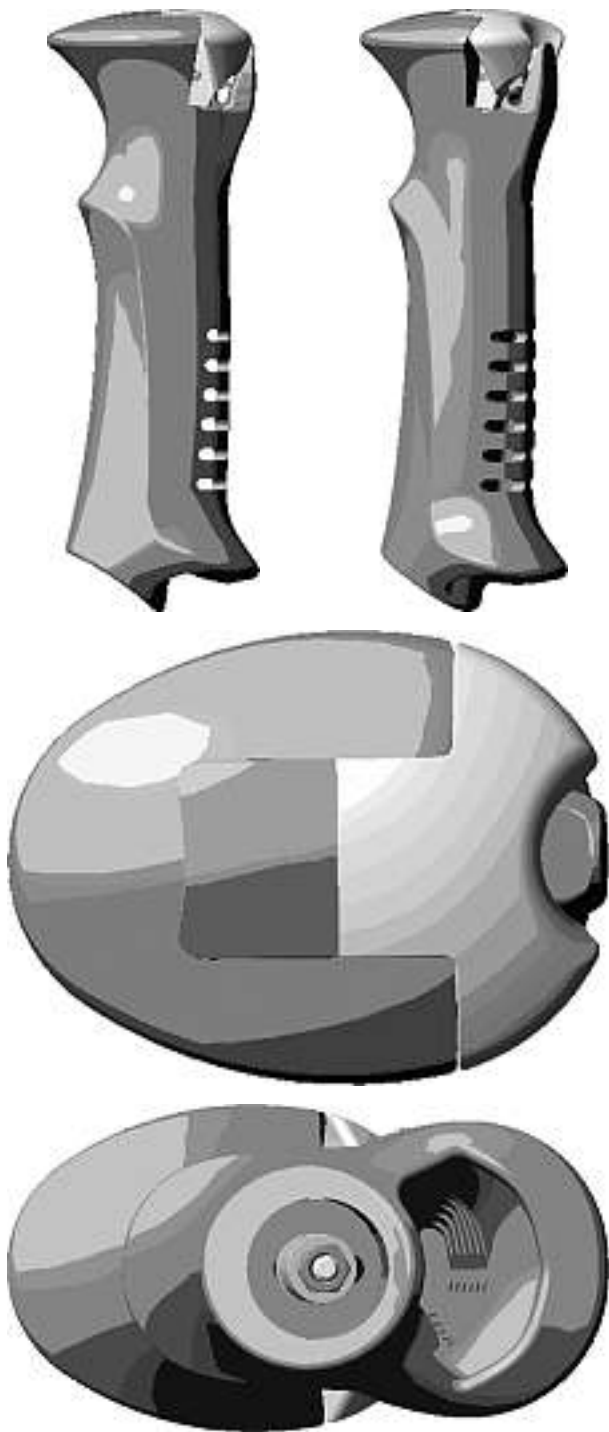

M13134-1

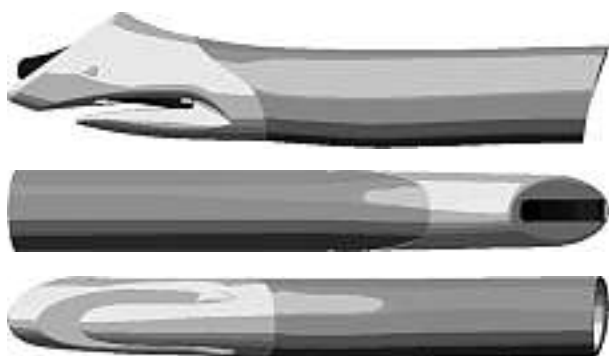

M13134-2

Cl. 23-02 **132 677** 02.03.2006  
1 design – colonne de douche  
Déposant: Drop S.r.l., Via Piemonte, 4,  
21040 Castronno (VA), IT  
Designer: Mirko Bosio, Sozzago  
Mandataire: SEDIN SA, 1207 Genève  
Priorité: EM, 01.02.2006





Cl. 24-01 **132 678** 21.02.2006  
1 Design – Bestrahlungskabine  
Hinterleger: Herbert Waldmann GmbH & Co. KG,  
Peter-Henlein-Strasse 5, 78056 Villingen-Schwenningen, DE  
Designer: Gerhard Waldmann, Dauchingen  
Vertreter: R. A. Egli & Co., Patentanwälte, 8008 Zürich  
Priorität: DE, 19.10.2005



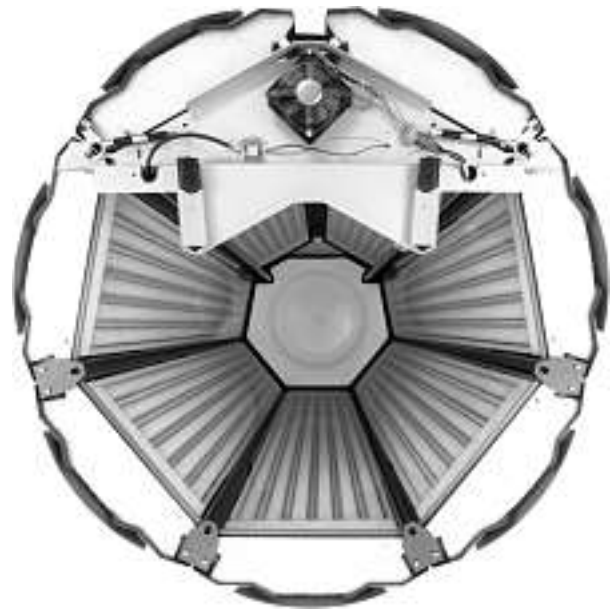

1

Cl. 25-01 **132 680** 24.02.2006  
 7 Design – Verankerungskomponente  
 Hinterleger: Danish Anchor System ApS, Roskildevej 48P,  
 Hillerød, DK  
 Designer: Carsten Aagerup, Slangerup  
 Vertreter: E. Blum & Co., 8044 Zürich  
 Priorität: EM, 25.08.2005

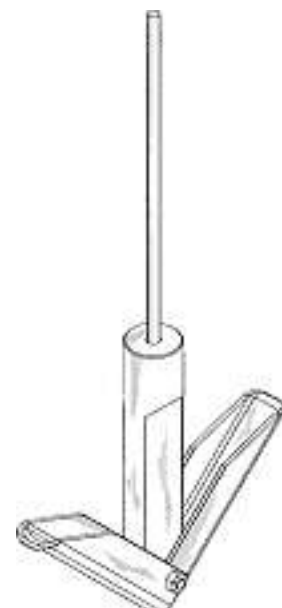

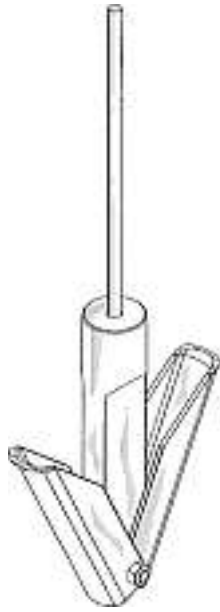

A-2006/1003a

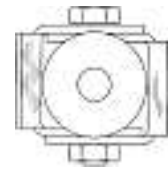
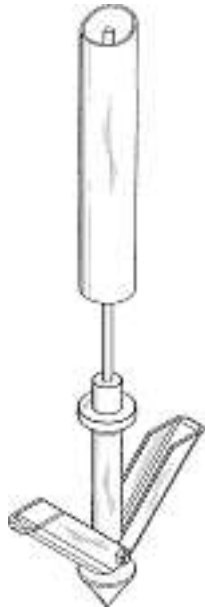

A-2006/1003b

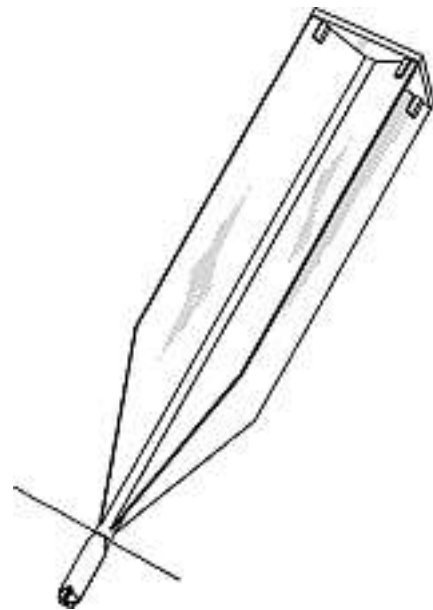
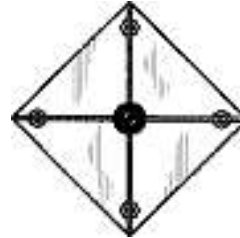

A-2006/1003c

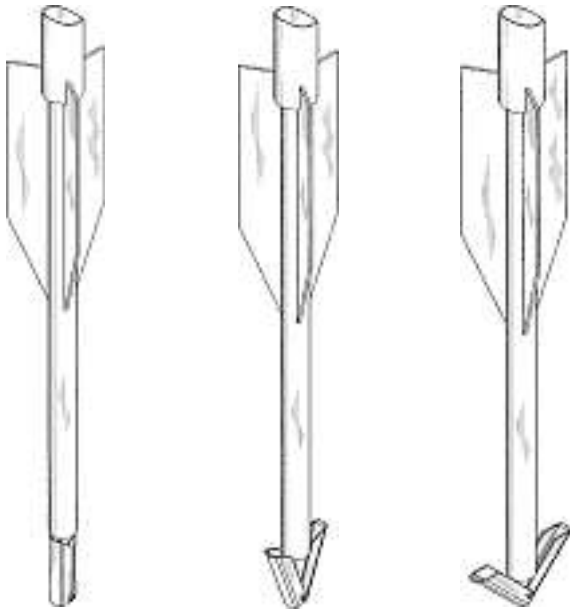

A-2006/1003d



A-2006/1003e

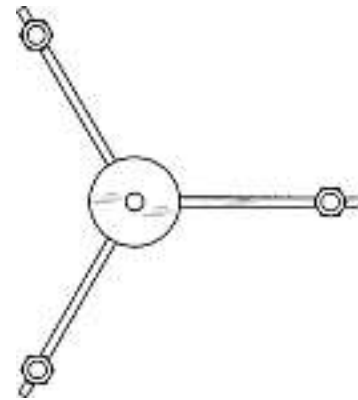

A-2006/1003f



A-2006/1003g

Cl. 25-02                      **132 681**                      13.02.2006  
 7 Design – Kipptore  
 Hinterleger: RUKU GmbH & Co. KG, Dietenheimer Strasse 51,  
 89257 Illertissen, DE  
 Designer: Gotthard Balles, Illertissen  
 Vertreter: Arie Wubben, 8942 Oberrieden  
 Priorität: EM, 19.09.2005



1

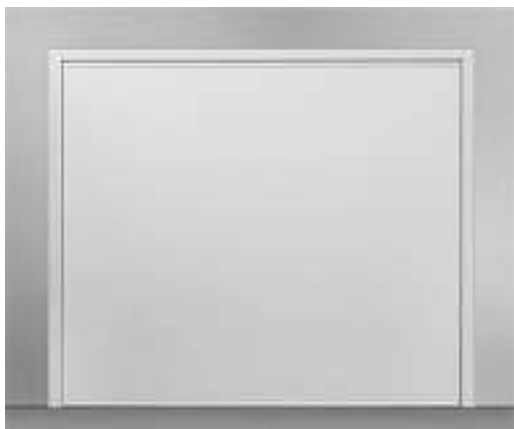

2



3



4



5



6



7

Cl. 26-05 132 682 10.02.2006  
4 Design – Leuchten  
Hinterleger: Hartmut S. Engel, Monrepos Strasse 7,  
Ludwigsburg, DE  
Vertreter: Patentanwälte, Schaad, Balass, Menzl & Partner AG,  
8034 Zürich

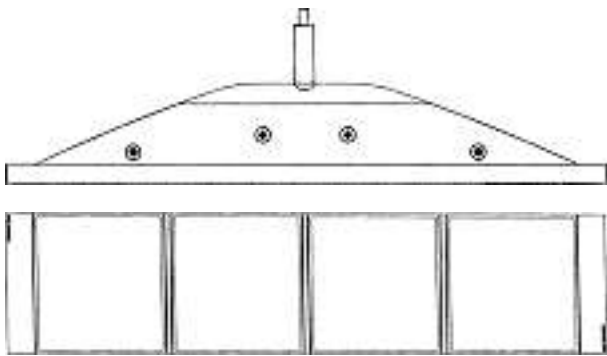
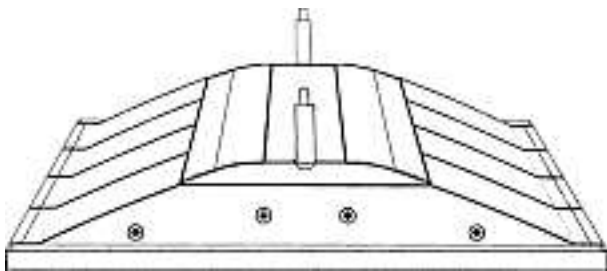
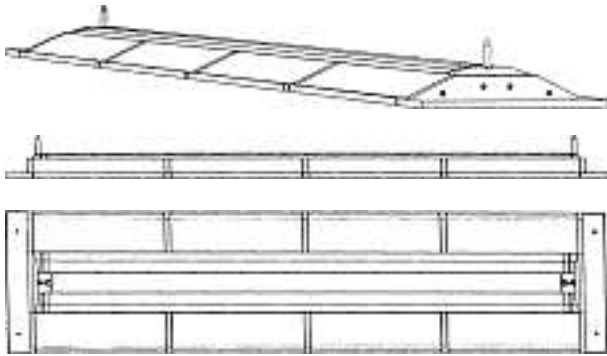

1

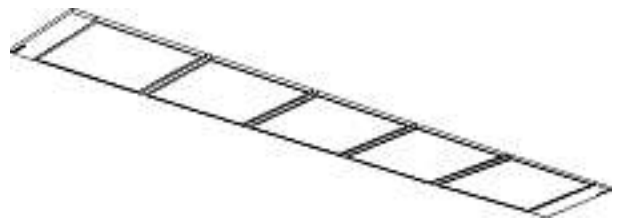
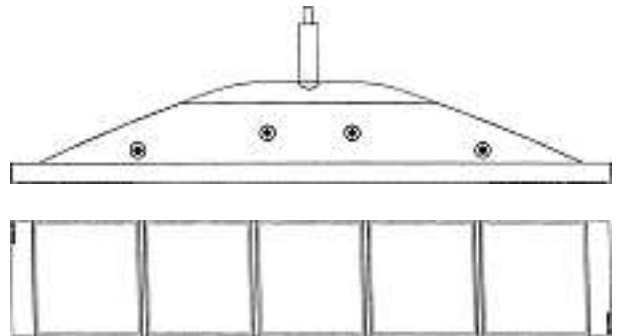
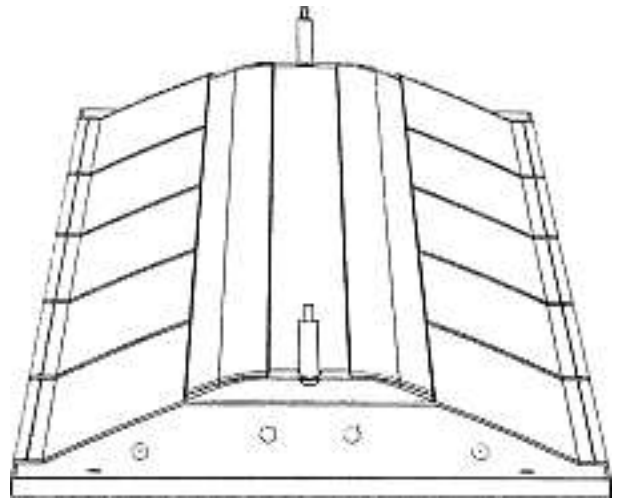
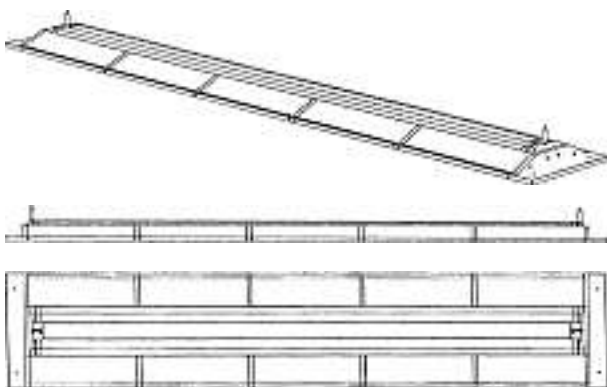

2

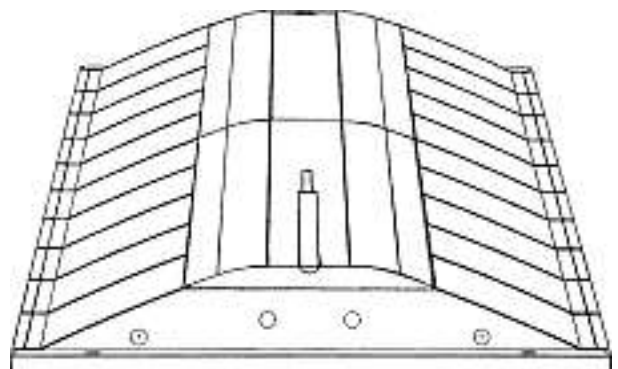
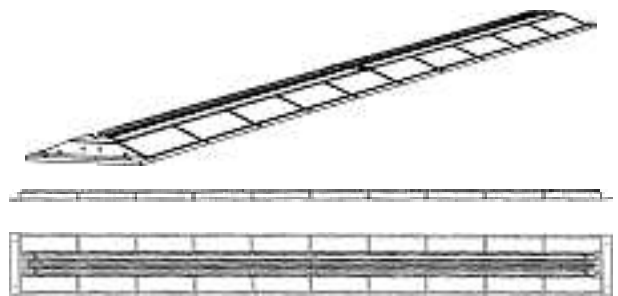

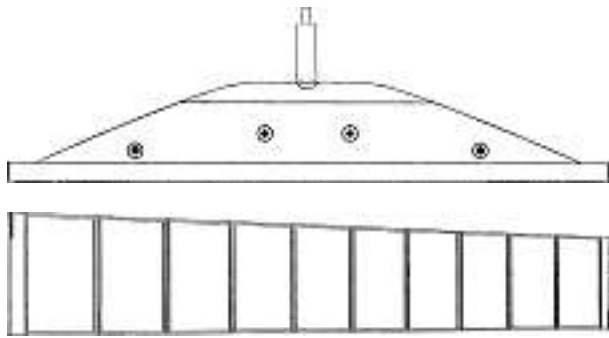

3

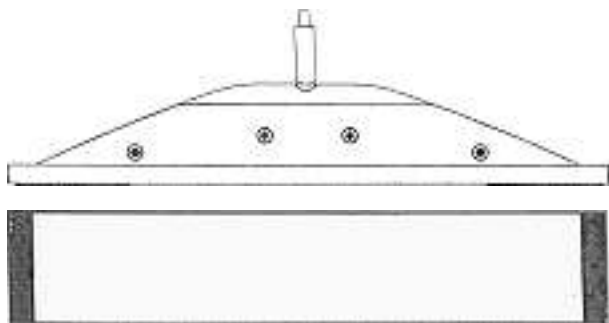
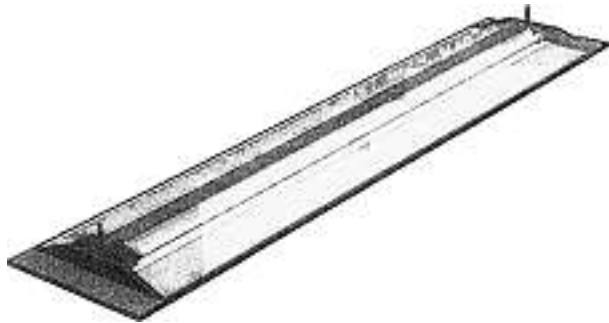
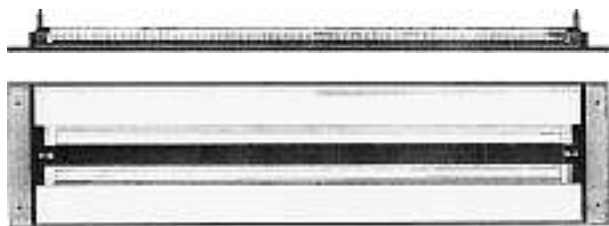

4

Cl. 30-02 132 683 09.03.2006  
1 design – aquarium  
Déposant: Julien Heyraud, Recorne 24b,  
2300 La Chaux-de-Fonds



1



**Verlängerungen  
Prolongations  
Prolongazioni**

118 444 Cl. 08-09 1 Design



1

118 939 Cl. 12-15 2 design

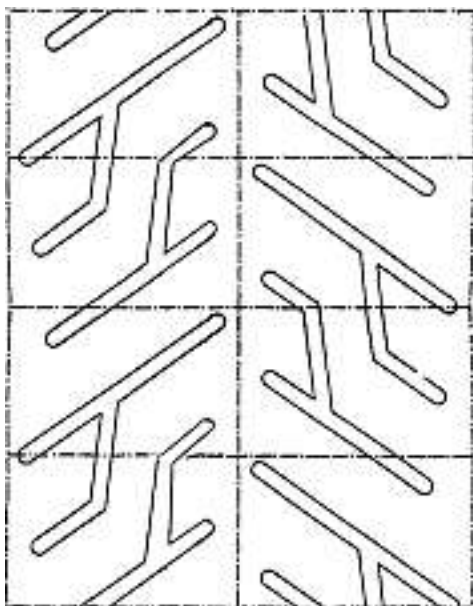

1

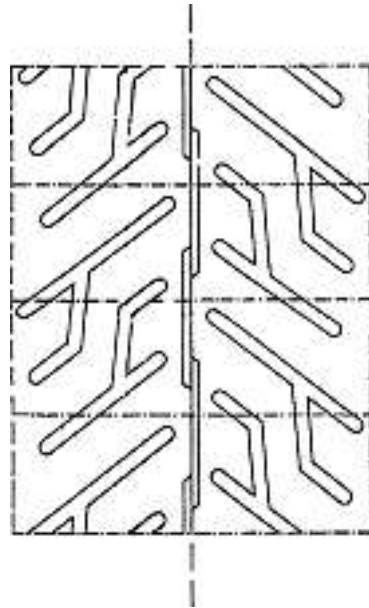

2

123 162	Cl.	07-01	1 Design
123 163	Cl.	07-01	1 Design
123 164	Cl.	07-01	2 Design
123 168	Cl.	07-02	1 Design
123 181	Cl.	09-09	1 Design
123 223	Cl.	11-01	9 Design
123 292	Cl.	25-01	2 Design
123 367	Cl.	24-02	1 design
123 387	Cl.	08-03	1 Design
123 436	Cl.	08-08	1 Design
123 444	Cl.	10-02	2 design
127 862	Cl.	01-03	1 Design
127 874	Cl.	07-01	1 Design
127 883	Cl.	09-03	3 Design
127 889	Cl.	12-14	1 Design
127 927	Cl.	29-01	1 Design
127 928	Cl.	29-01	1 Design
127 938	Cl.	07-01	1 Design
127 973	Cl.	07-02	3 Design
128 002	Cl.	04-02	1 Design
128 003	Cl.	04-02	1 Design
128 021	Cl.	10-07	2 Design
128 070	Cl.	24-04	1 Design
128 133	Cl.	24-02	1 design
128 148	Cl.	06-04	2 Design
128 351	Cl.	09-01	2 Design



## Mutationen Modifications Modificazioni

### 119 103

Vertreter Firmaänderung  
Vertreter: Unilever Schweiz Service AG, 6330 Cham 2

### 124 256

### 127 258

Übertragung  
Hinterleger: Alpod LLC, Corporation Service Company,  
2711 Centerville Road, Suite 400, Wilmington, DE, US  
Vertreter: BUDIN & ASSOCIÉS, 1211 Genève 12

### 128 535

Übertragung  
Hinterleger: Janis Laikovskis, Sporta iela 6-5, Limbazi, LV  
Vertreter: M. ZARDI & CO. S.A., 6900 Lugano

### 128 959

Cambiamento di nome/  
Cambiamento di nome/  
Cambiamento di nome  
Depositante: ALARIS Medical, Inc., 10221 Wateridge Circle,  
Building A, San Diego, CA 92121-2733, US  
Depositante: ALARIS Medical Systems, Inc., 10221 Wateridge  
Circle, Building A, San Diego, CA 92121-2733, US  
Depositante: Cardinal Health 303, Inc., 10221 Wateridge  
Circle, Building A, San Diego, CA 92121-2733, US

### 130 666

Übertragung  
Hinterleger: Parat-Werk, Schönenbach GmbH + Co. KG,  
Tenter Weg 1-3, Remscheid, DE  
Vertreter: Luchs & Partner, Patentanwälte, 8002 Zürich

## Löschungen Radiations Radiazioni

118 483	Cl.	09-05	13	Design
118 498	Cl.	23-03	2	Design
118 501	Cl.	25-02	2	Design
118 553	Cl.	14-02	1	Design
118 621	Cl.	14-02	1	Design
122 683	Cl.	06-03	1	Design
122 693	Cl.	08-08	1	Design
122 697	Cl.	09-05	2	Design
122 698	Cl.	09-04	1	Design
122 705	Cl.	10-04	1	Design
122 706	Cl.	10-06	8	Design
122 719	Cl.	26-04	1	Design
122 722	Cl.	99-00	1	Design
127 341	Cl.	20-03	1	design
127 350	Cl.	28-03	1	design
127 351	Cl.	02-01	1	Design
127 355	Cl.	06-01	2	Design
127 358	Cl.	06-03	2	Design
127 360	Cl.	06-04	1	Design
127 361	Cl.	07-01	1	Design
127 362	Cl.	07-01	2	Design
127 365	Cl.	07-04	1	Design
127 371	Cl.	09-01	1	Design
127 375	Cl.	09-09	1	Design
127 378	Cl.	11-01	1	design
127 380	Cl.	12-11	1	Design
127 381	Cl.	12-11	1	Design
127 383	Cl.	14-01	1	Design
127 386	Cl.	15-05	1	design
127 387	Cl.	15-05	1	design
127 389	Cl.	17-04	35	design
127 390	Cl.	18-99	1	design
127 391	Cl.	20-02	1	Design
127 392	Cl.	20-03	1	design
127 394	Cl.	21-01	6	Design
127 395	Cl.	21-01	1	Design
127 398	Cl.	23-01	1	Design
127 402	Cl.	26-04	1	Design
127 403	Cl.	26-05	1	Design
127 406	Cl.	28-03	1	design
127 445	Cl.	24-02	2	Design
127 474	Cl.	15-09	1	Design
127 478	Cl.	21-01	1	Design
127 556	Cl.	14-02	1	Design