

Nationale Hinterlegungen

In der folgenden Liste werden die beim Eidgenössischen Institut für Geistiges Eigentum hinterlegten Designs publiziert. Dabei sind der Reihe nach angegeben:

- internationale Klassenangaben
- Hinterlegungsnummer
- Hinterlegungsdatum
- Allenfalls Aufschub der Veröffentlichung
- Anzahl der hinterlegten Designs
- Bezeichnung
- Name und Wohnsitz des Hinterlegers oder der Hinterlegerin
- gegebenenfalls Name und Wohnsitz des Designers oder der Designerin
- Name und Geschäftssitz des allfälligen Vertreters oder der Vertreterin
- gegebenenfalls Prioritätsangaben
- gegebenenfalls Beschreibungstext
- Ordnungsnummer
- Reproduktion des Designs

Internationale Hinterlegungen

Die bei der Weltorganisation für geistiges Eigentum in Genf hinterlegten Muster und Modelle mit Benennung Schweiz geniessen den gleichen Schutz wie national hinterlegte Designs. Sie werden jeweils im Blatt «Bulletin des dessins et modèles internationaux» veröffentlicht. Dieses Publikationsorgan ist deshalb für eine vollständige Recherche unbedingt beizuziehen.

Topographien

Angaben über die vom Eidgenössischen Institut für Geistiges Eigentum eingetragenen Topographien von Halbleitererzeugnissen werden in folgender Anordnung aufgeführt:

- Eintragsnummer
- Anmeldedatum
- Bezeichnung
- Name und Wohnsitz des Anmelders oder der Anmelderin
- gegebenenfalls Name und Wohnsitz des Herstellers oder der Herstellerin
- Name und Geschäftssitz des oder der allfälligen Bevollmächtigten
- Datum und Ort einer allfälligen ersten geschäftlichen Verbreitung der Topographie

Dépôts nationaux

Les designs déposés à l'Institut Fédéral de la Propriété Intellectuelle sont publiés dans la liste qui suit. Les indications y relatives sont mentionnées dans cet ordre:

- indications des classes internationales
- numéro de dépôt
- date de dépôt
- le cas échéant, ajournement de la publication
- nombre des designs déposés
- désignation
- nom et domicile du/de la déposant/e
- le cas échéant, nom et domicile du/de la designer
- nom et domicile de l'éventuel/le mandataire
- le cas échéant, indication de priorité
- le cas échéant, description du design
- numéro attribué à chaque design
- reproduction du design

Dépôts internationaux

Les dessins et modèles déposés à l'Organisation Mondiale de la Propriété Intellectuelle à Genève qui désignent la Suisse jouissent de la même protection que les dépôts nationaux. Ils sont chaque fois publiés dans la feuille «Bulletin des dessins et modèles internationaux». Pour une recherche complète, il est indispensable de consulter ledit organe de publication.

Topographies

Les indications concernant les topographies des produits semi-conducteurs, enregistrées par l'Institut Fédéral de la Propriété Intellectuelle, sont énumérées dans l'ordre suivant:

- numéro d'enregistrement
- date de dépôt
- désignation
- nom et domicile du/de la déposant/e
- le cas échéant, nom et domicile du/de la producteur/trice
- nom et domicile de l'éventuel/le mandataire
- date et lieu d'une éventuelle première mise en circulation de la topographie

Depositi nazionali

Nella lista seguente vengono pubblicati i design depositati presso l'Istituto Federale della Proprietà Intellettuale. Sono menzionati nel seguente ordine:

- indicazioni delle classi internazionali
- numero di deposito
- data del deposito
- se del caso, indicazione che la pubblicazione è stata differita
- numero dei design depositati
- designazione
- nome e domicilio del depositante
- se del caso, nome e domicilio del designer
- nome e sede di un eventuale mandataro
- se del caso, indicazioni di priorità
- se del caso, descrizione del design
- numero d'ordine
- riproduzione del design

Depositi internazionali

I disegni e modelli depositati presso l'Organizzazione Mondiale della Proprietà Intellettuale a Ginevra con denominazione Svizzera godono della medesima protezione del deposito nazionale. Essi vengono pubblicati ogni volta nel foglio «Bulletin des dessins et modèles internationaux». Quest'organo di pubblicazione è da consultare se si vuole effettuare una ricerca completa.

Topografie

Le indicazioni concernenti le topografie di prodotti a semiconduttori depositati presso l'Istituto Federale della Proprietà Intellettuale sono menzionate nell'ordine seguente:

- numero di registrazione
- data del deposito
- designazione
- nome e domicilio del/la richiedente
- se del caso, nome e domicilio del/la produttore/trice
- nome e sede di un eventuale mandataro
- data e luogo di un'eventuale prima messa in circolazione della topografia

Hinterlegungen Dépôts Deposit

Cl. 10-02 131 376 27.01.2005
1 design – montre-bracelet
Déposant: La Montre Hermès SA, Erlenstrasse 31A,
2555 Brügg
Designer: Philippe Mouquet, Paris
Mandataire: Inteltech SA, 2001 Neuchâtel

Fin de la période ajournement de la publication



153730/010003

Cl. 10-07 131 722 28.04.2005
1 design – calibre de montre
Déposant: Desco von Schulthess AG, Brandschenkestrasse 2,
8002 Zürich
Designer: Patrick Graells, La Neuveville
Mandataire: Inteltech SA, 2000 Neuchâtel

Fin de la période ajournement de la publication



1

Cl. 10-02 131 888 29.06.2005
2 design – montres-bracelets
Déposant: Luxury Timepieces International SA, Ch. des
Rochettes 2, 2016 Cortaillod
Designer: Dino Modolo, La Chaux-de-Fonds
Mandataire: Inteltech SA, 2001 Neuchâtel

Fin de la période ajournement de la publication





1



2

Cl. 10-02 131 939 08.07.2005

1 design – montre-bracelet

Déposant: Luxury Timepieces International SA, Ch. des

Rochettes 2, 2016 Cortaillod

Designer: Christian Bédard, Genève

Mandataire: Inteltech SA, 2001 Neuchâtel

Fin de la période ajournement de la publication





1

Cl. 10-02 131 940 11.07.2005

4 design – montres-bracelets

Déposant: Luxury Timepieces International SA, Ch. des Rochettes 2, 2016 Cortaillod

Designer: Christian Bédard, Genève

Mandataire: Inteltech SA, 2001 Neuchâtel

Fin de la période ajournement de la publication





1



2



3





4

Cl. 10-02 **132 000** 18.07.2005
 1 design – montre-bracelet
 Déposant: Luxury Timepieces International SA, Ch. des
 Rochettes 2, 2016 Cortaillod
 Designer: Christian Bédard, Genève
 Mandataire: Inteltech SA, 2001 Neuchâtel

Fin de la période ajournement de la publication



1

Cl. 10-01 10-02 **132 056** 27.07.2005
 3 design – montre-bracelet, montre de table, montre de
 poche
 Déposant: Bovet Fleurier SA, Avenue Daniel-Jeanrichard,
 2114 Fleurier
 Designer: Pascal Raffy, Genolier
 Mandataire: Inteltech SA, 2001 Neuchâtel
 Fin de la période ajournement de la publication



1 Description du design: La bélière s'ouvre pour permettre la fixation d'un bracelet (modèle 1).





2 Description du design: La bélière peut s'ouvrir également pour la fixation d'une chaînette pour transformation en montre de poche (modèle 2).



3 Description du design: Lors de l'utilisation en pendulette/montre de table, un élément se fixe à l'intérieur de la bélière pour combler l'ouverture du passage du bracelet. La fermeture de la bélière se fait à l'aide de cliquets à pivots. Lors de la transformation (passage de la montre avec bracelet à la montre de poche ou pendulette) l'attache située à 6h. est remplacée par un socle. En ouvrant le fond plein et en le faisant pivoter de 80° vers l'arrière, ce dernier sert de pied à la pendulette (modèle 3).

Cl. 10-02 132 163 11.10.2005

1 design – montre-bracelet

Déposant: Luxury Timepieces International SA, Ch. des Rochettes 2, 2016 Cortaillod

Designer: Christian Bédard, Genève

Mandataire: Inteltech SA, 2001 Neuchâtel

Fin de la période ajournement de la publication



Cl. 10-07 132 521 24.01.2006
3 design – montres
Déposant: François-Paul Journe, 17, rue de l'Arquebuse,
1204 Genève
Mandataire: Inteltech SA, 2001 Neuchâtel

Fin de la période ajournement de la publication





Automatique reserve



Centigraphe





Cl. 02-01 132 589 20.02.2006
 12 Design – Manschette
 Hinterleger: Metzler & Co. AG, Hauptstrasse 33, 9436 Balgach
 Designer: Tino Mastroberardino, Au
 Vertreter: Hans Rudolf Gachnang, Patentanwalt, 8501
 Frauenfeld

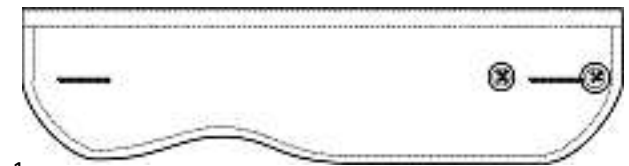

1

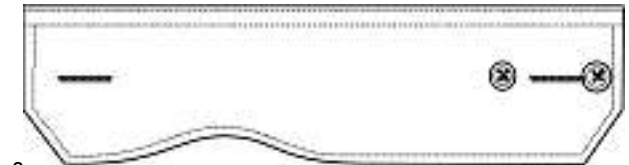

2

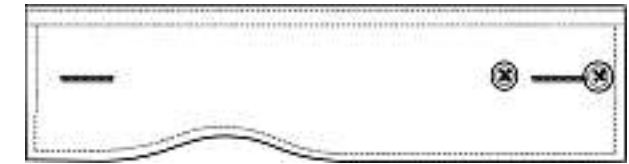

3

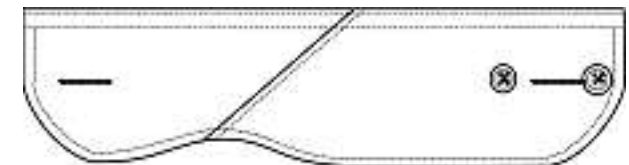

4

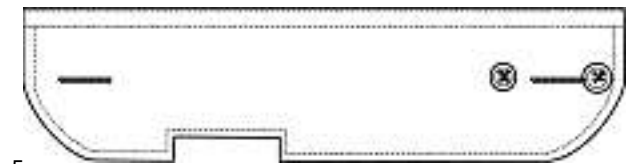

5

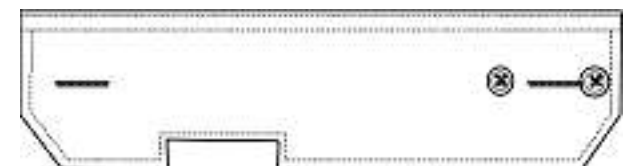

6



7

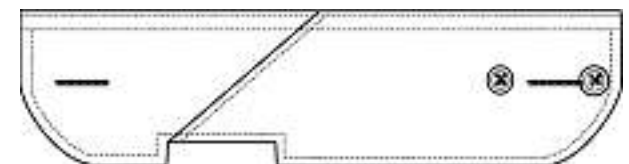

8

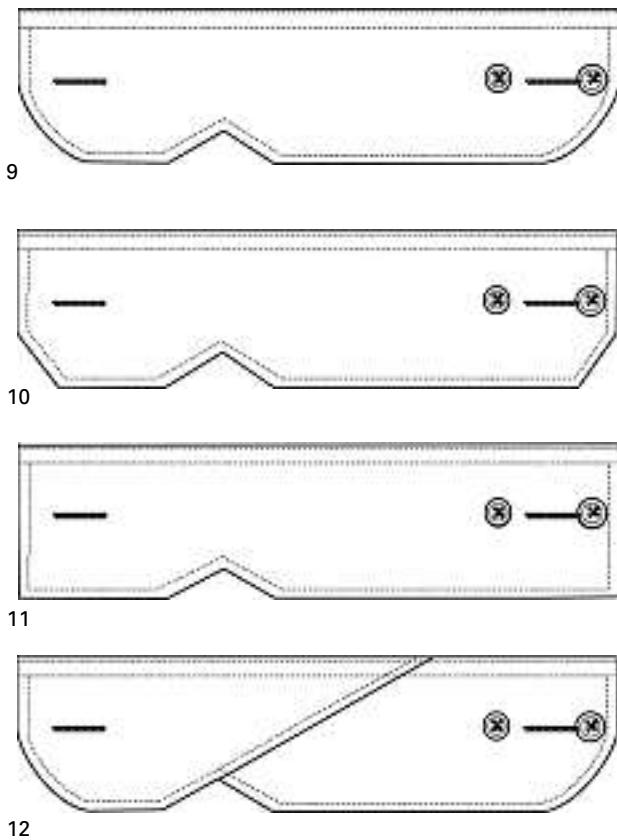

1
Cl. 02-02 **132 591** 01.03.2006

2 Design – Startnummern
Hinterleger: Otto Stalder, Dürimatt 14, Niedermettlen, 3182 Ueberstorf
Vertreter: Fuhrer Marbach & Partner, 3007 Bern
Beschreibung des Designs: Das hinterlegte Design zeigt eine als «Body» gestaltete Startnummer für Sportler, so z. B. Skispringer, Skirennfahrer, Langläufer etc. Das wesentliche Merkmal der Gestaltung besteht in der Ausgestaltung der Startnummer als «Body».

Cl. 02-02 **132 590** 21.02.2006
1 Design – T-Shirt
Hinterleger: Stefan Engelhardt, Alte Rabenstrasse 32, 20148 Hamburg, DE
Vertreter: Ammann Patentanwälte AG Bern, 3001 Bern
Beschreibung des Designs: T-Shirt bedruckt mit einer Vielzahl von Personennamen von Anhängern, Fans, usw.



Body Startnummern 1



Body Startnummern 2

Cl. 02-04 132 592 02.02.2006
2 Design – Sohle
Hinterleger: David R. Sellers, 3305 County Road 96, Ward,
CO, US
Vertreter: R. A. Egli & Co., Patentanwälte, 8008 Zürich
Priorität: US, 02.08.2005

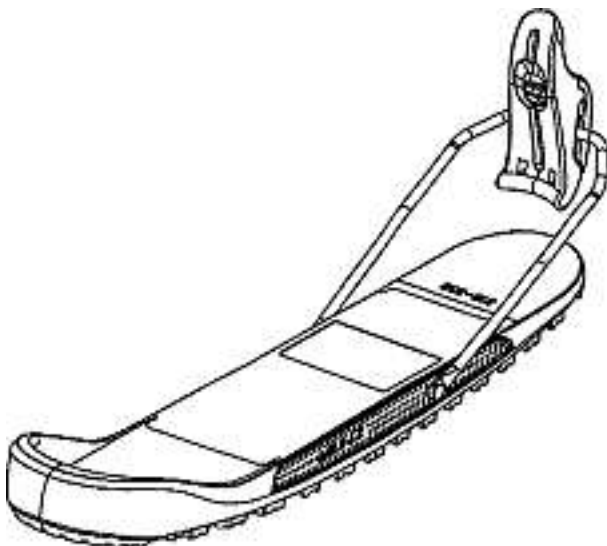
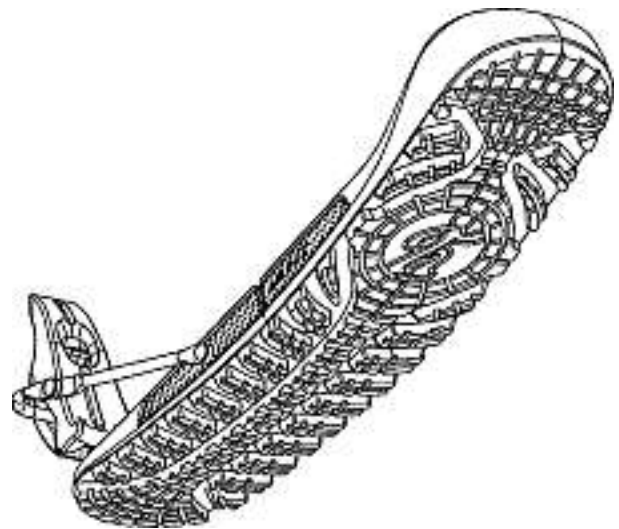
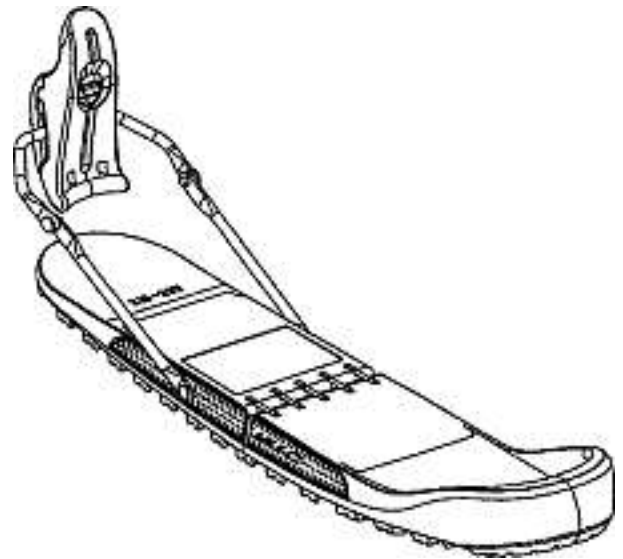

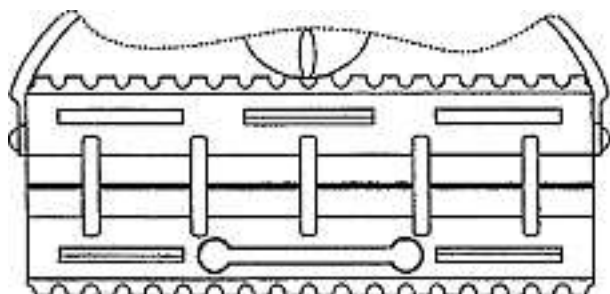
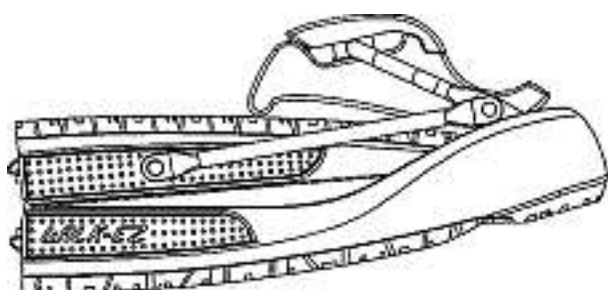

Cl. 03-01 132 594 22.02.2006
 1 Design – Etui
 Hinterleger: Angelika Funkhouser, Weberfeld 3, Schwaz, AT
 Vertreter: Breiter + Partner AG, Patent- und Markenbüro,
 8413 Neftenbach
 Priorität: EM, 15.09.2005

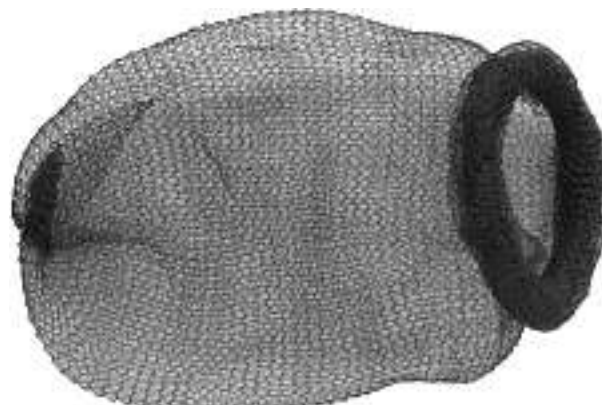

0001.1

Cl. 04-02 132 595 08.02.2006
 6 Design – Zahnbürstengriff
 Hinterleger: Colgate-Palmolive Company, 300 Park Avenue,
 New York (NY), US
 Designer: Eduardo Jimenez, Manalapan; Daniel F. Cuffaro,
 Lakewood; Christine Enderby, Chelsea; Thomas Swyst,
 Arlington
 Vertreter: E. Blum & Co., 8044 Zürich
 Priorität: US, 17.08.2005

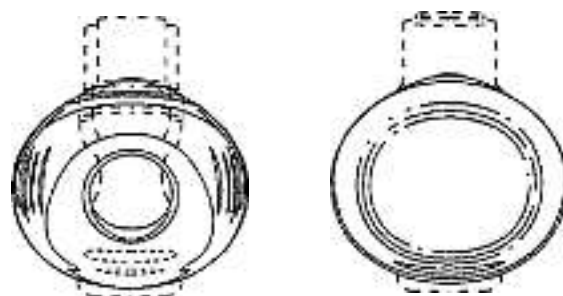
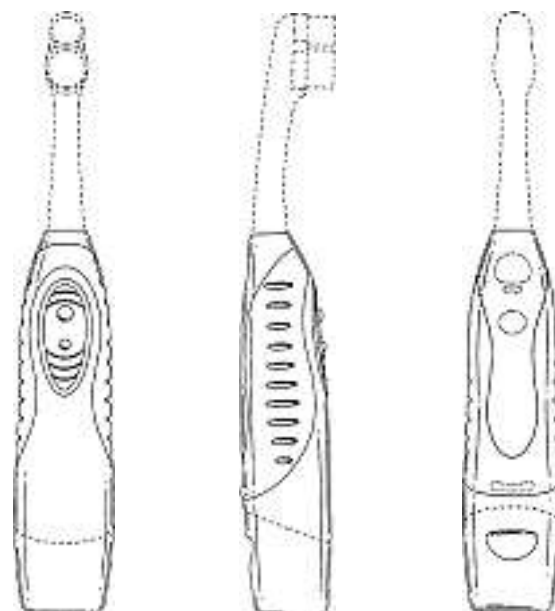

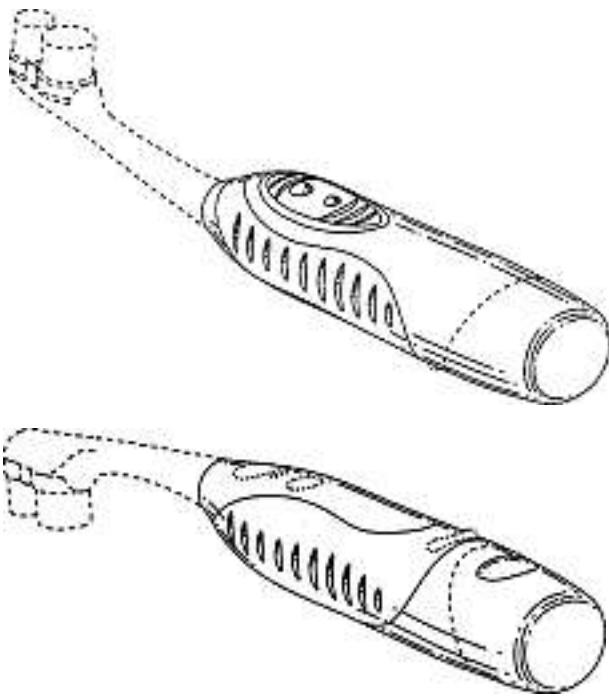

A-2006/1002a

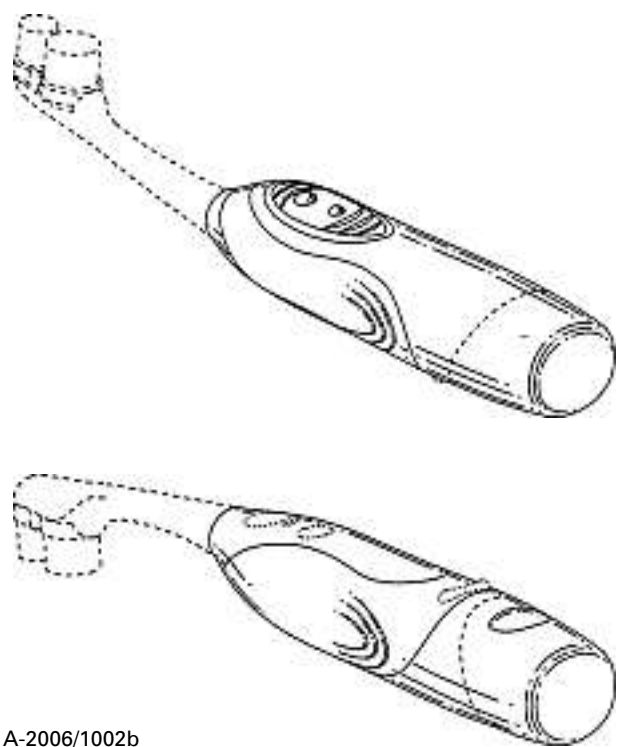

A-2006/1002b

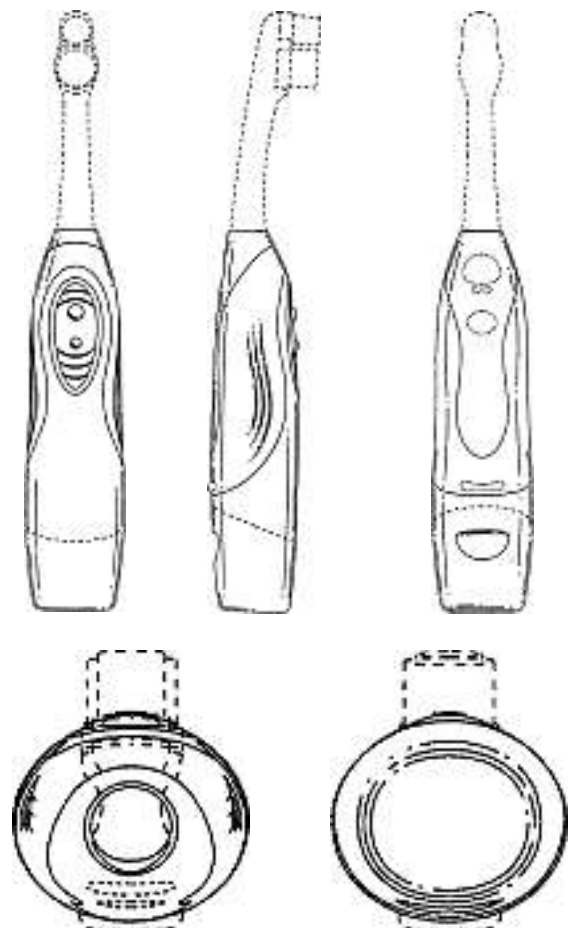
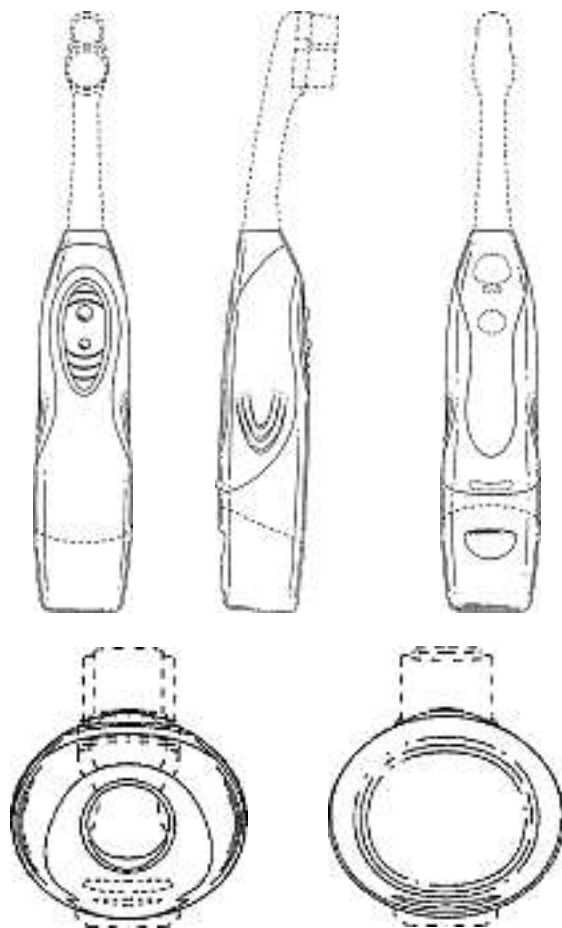

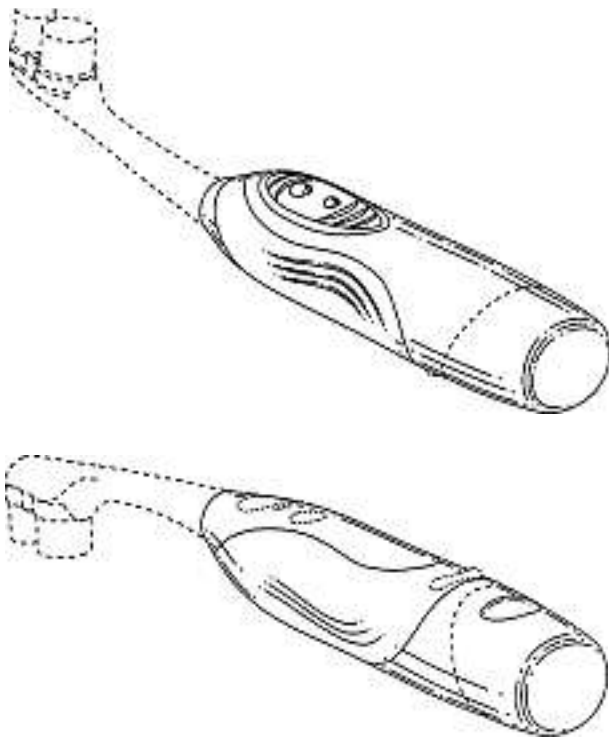

A-2006/1002c

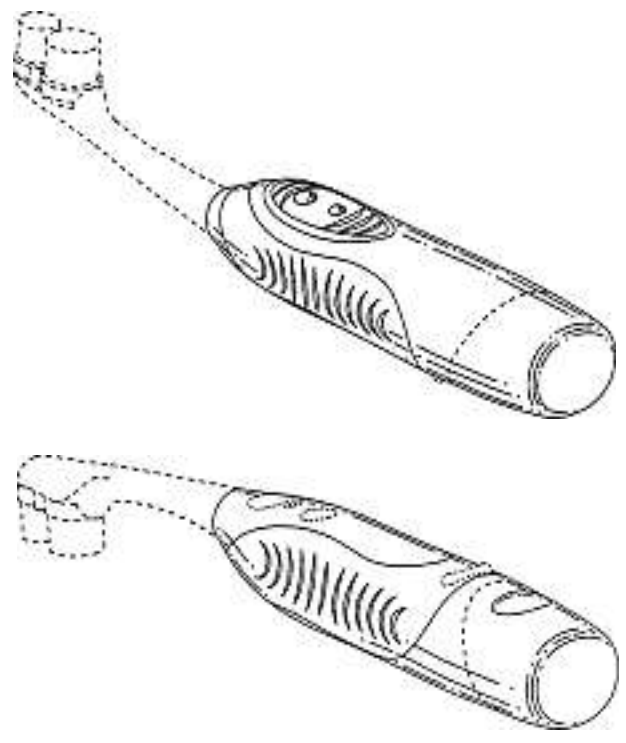

A-2006/1002d

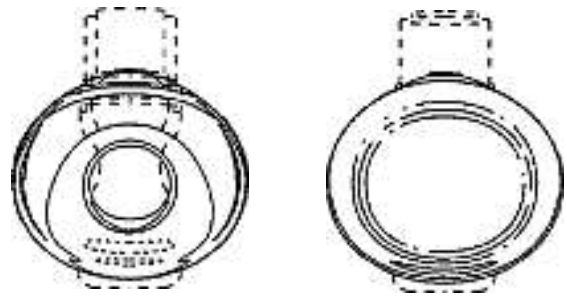
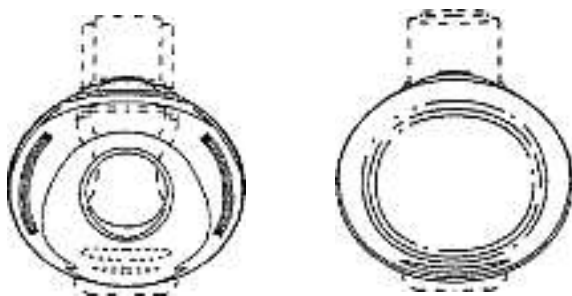
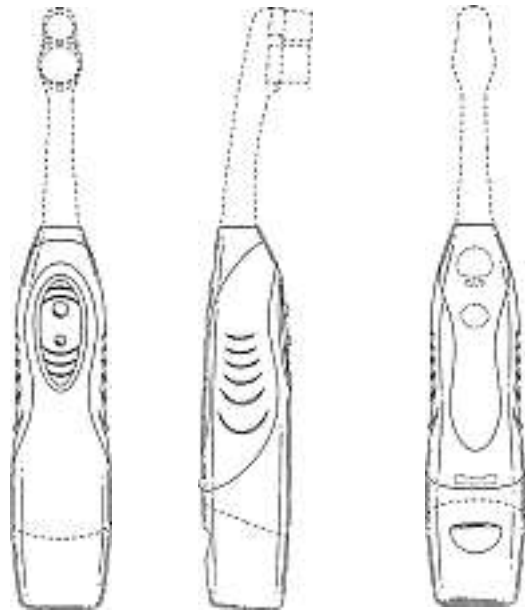
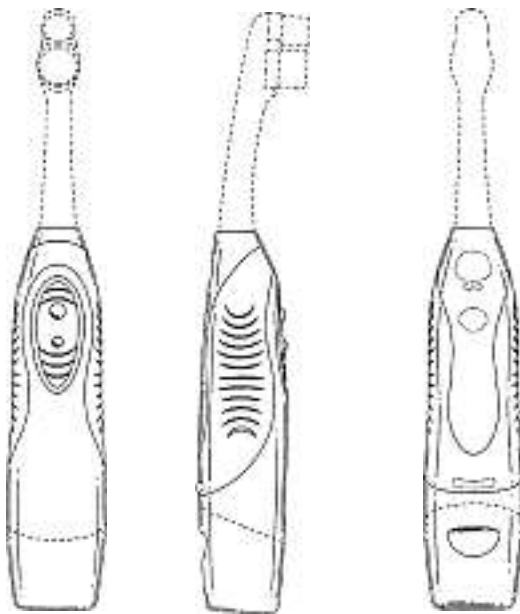



01

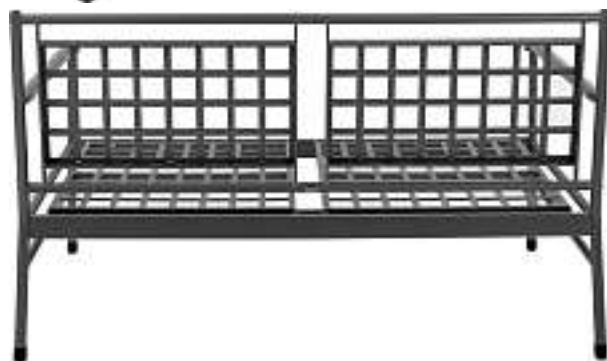
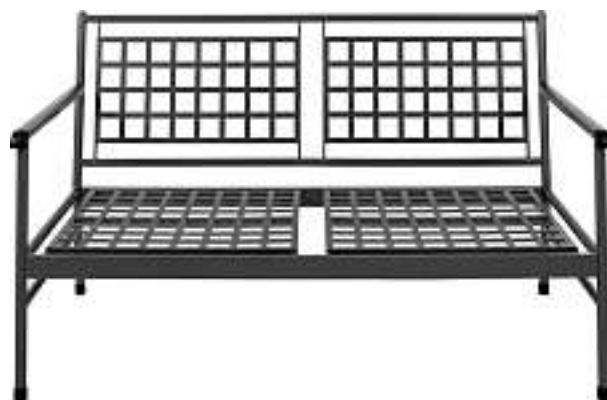

02



03







05



06



07

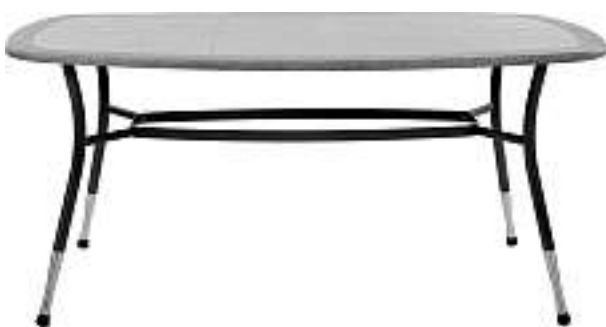

08





09



11



12



10





13









16





17

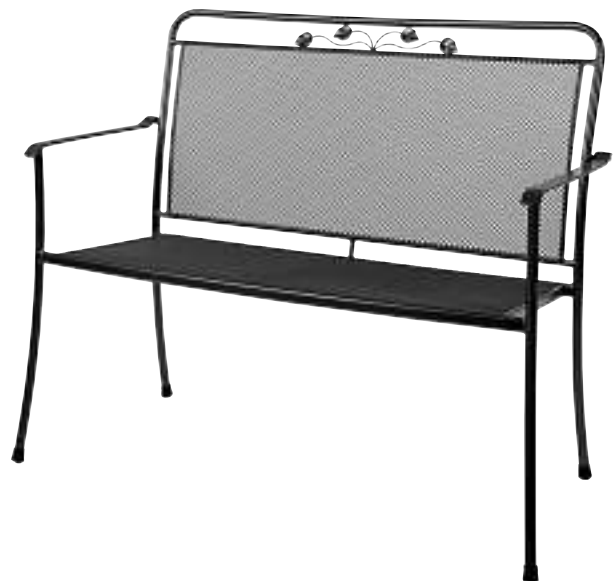
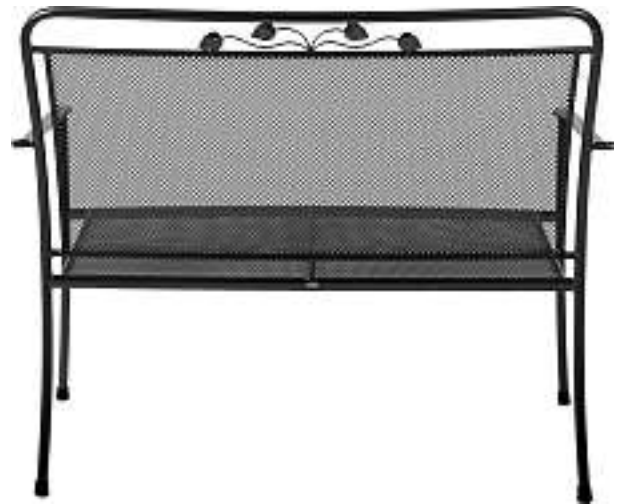

18



19





20



23



21



22



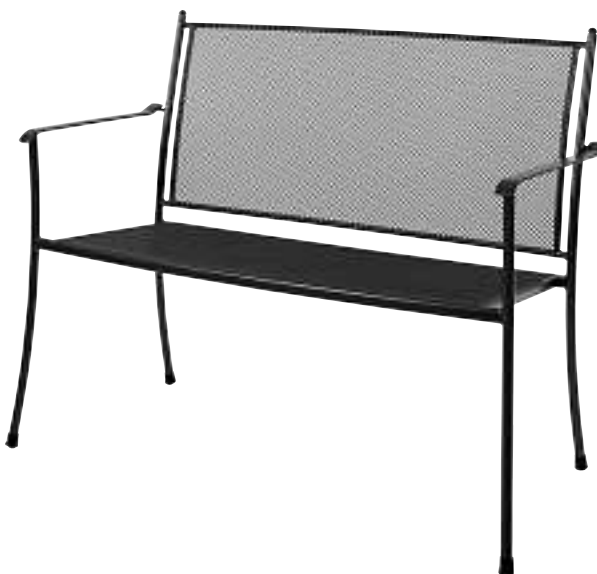



25



26



27



28



29





30



31

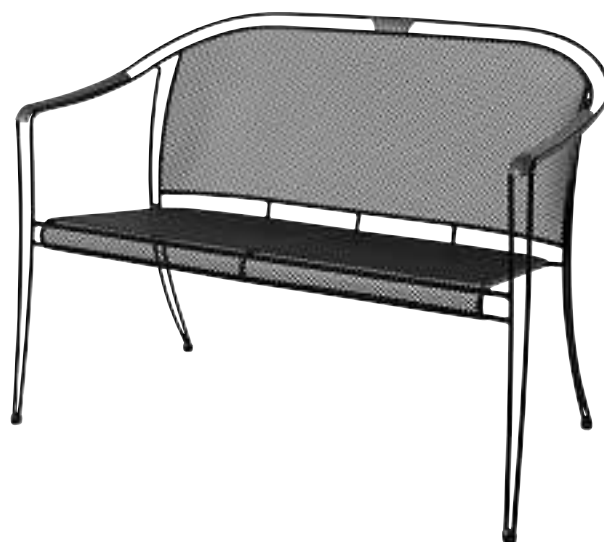



32





33





34





35



36



37

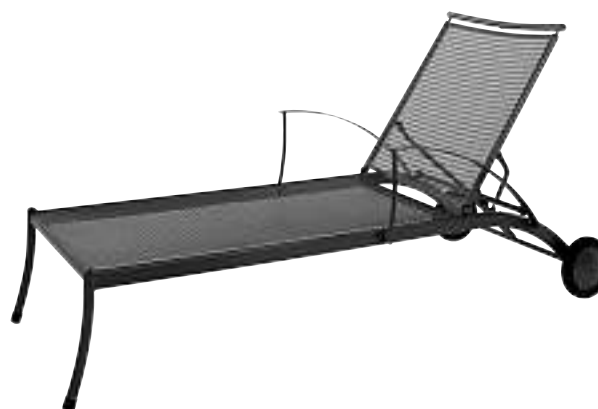

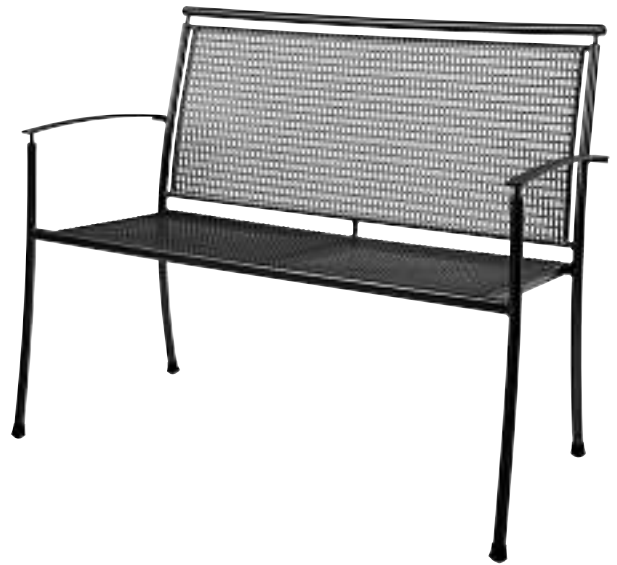
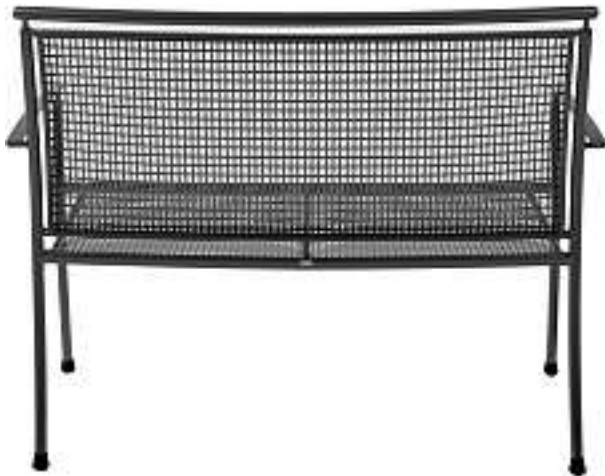

38





39





40



41





42





43







45



46





47

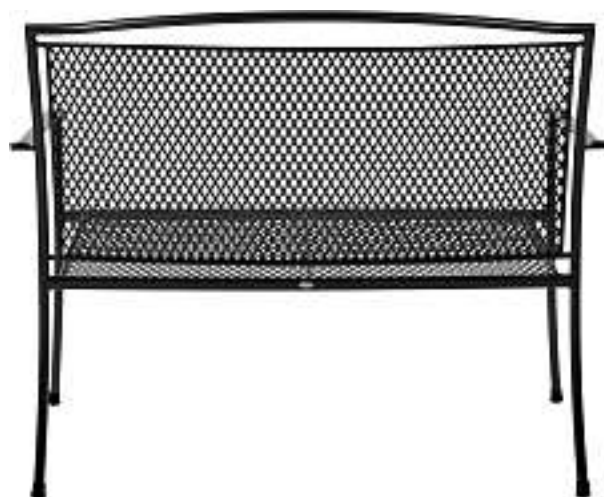



48



49





50



51



52



53



54





55



56



57



58







60



61



62

63

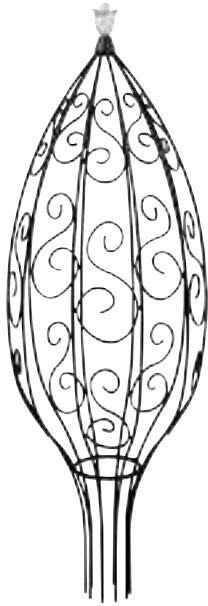

64

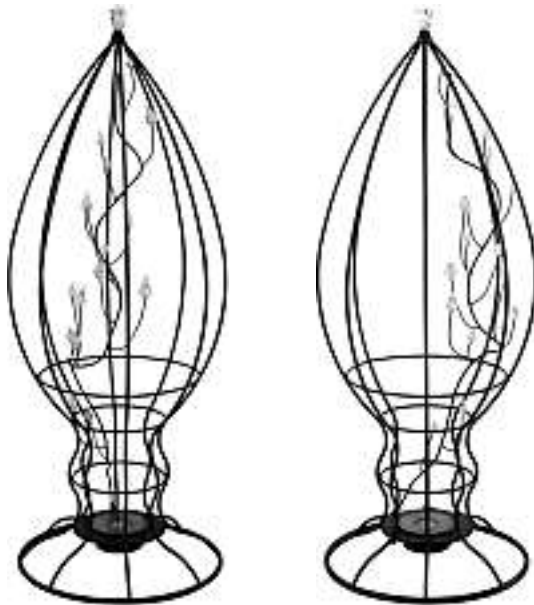

66

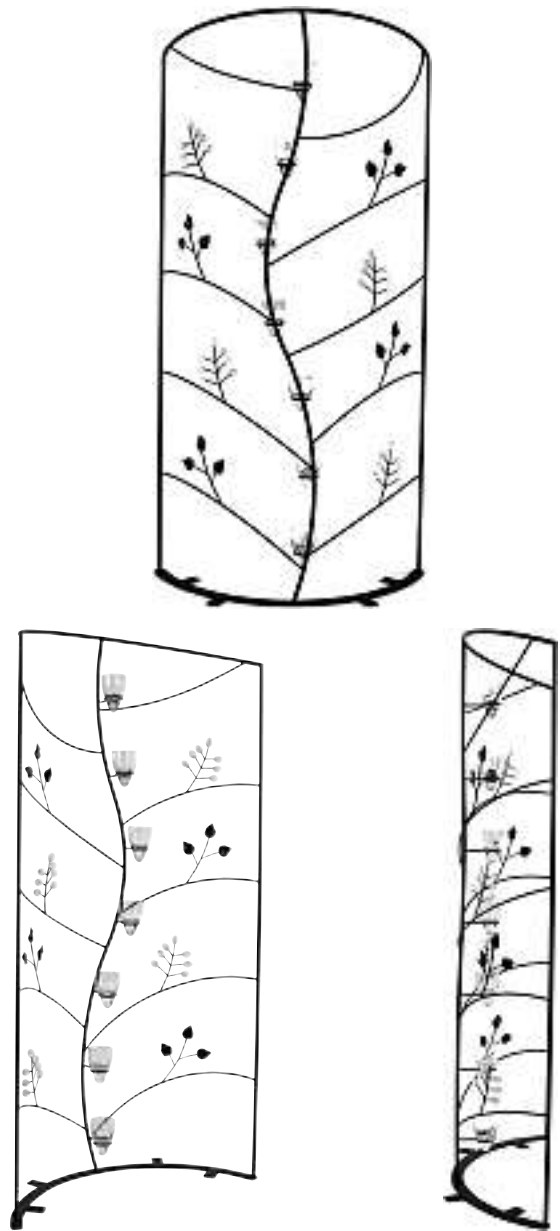

65

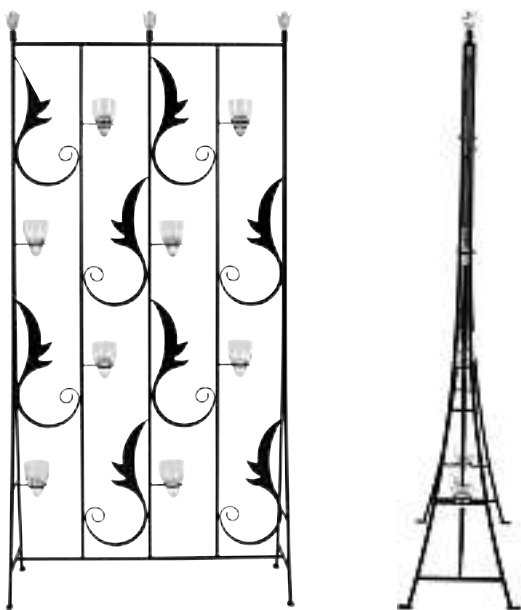

Cl. 06-02 132 597 22.02.2006
1 Design - Bett
Hinterleger: Daniel Jauslin, Wildbachstrasse 48, 8008 Zürich



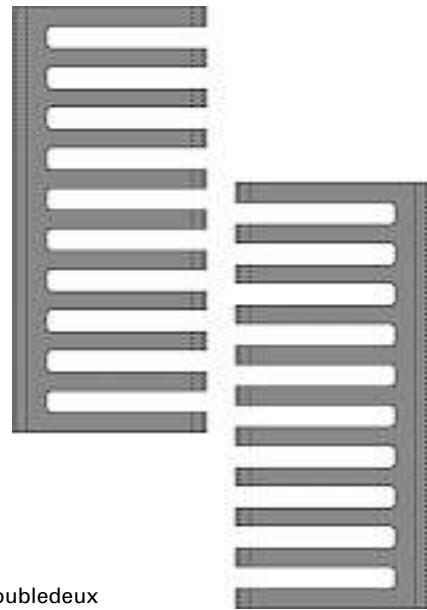
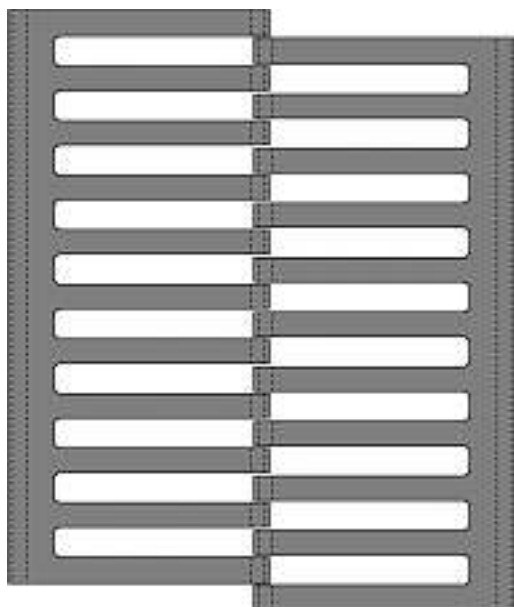
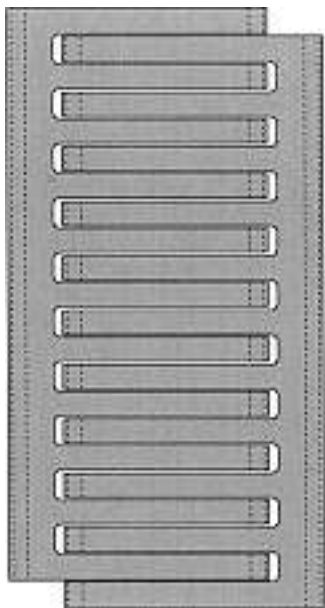

simpledoubledeux

Cl. 06-06 132 598 11.01.2006
3 Design – Möbelteil
Hinterleger: Merz & Isler AG, Alte Stockstrasse 7,
5022 Rombach
Designer: Stephan Bircher, Aarau



0513501

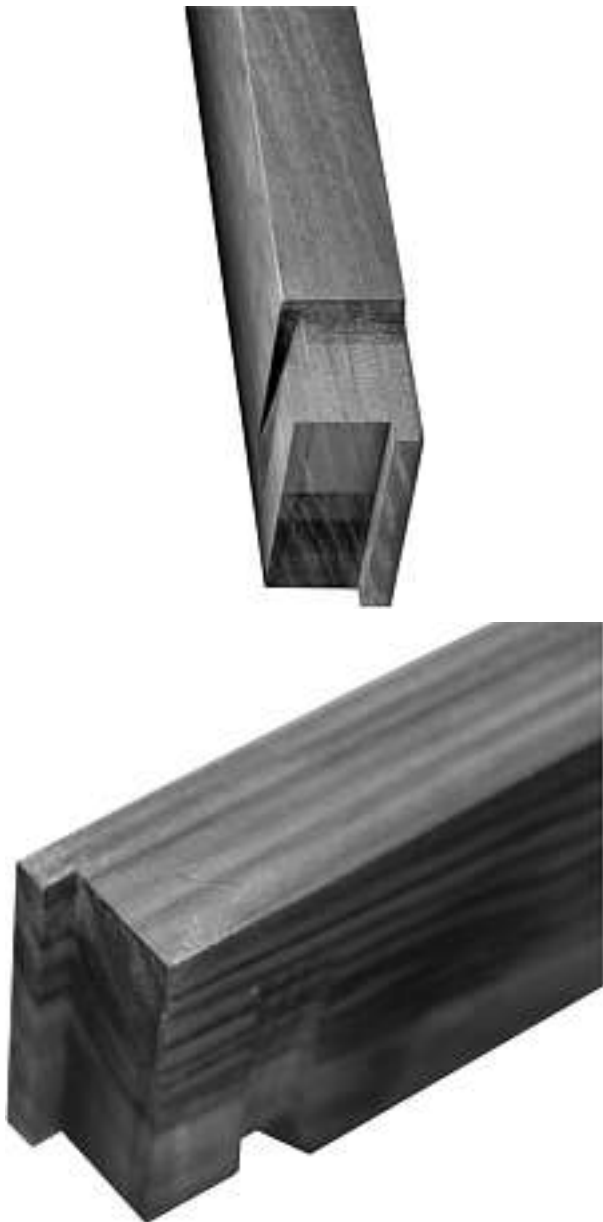

0513502
0513503



Cl. 07-01 **132 599** 07.02.2006
1 Design – Früchte-Schale
Hinterleger: Werner Zemp, Rehweg 2, 8044 Gockhausen



1

Cl. 07-01 **132 600** 09.02.2006
1 design – accessoire pour carafe
Déposant: Heinz Lamprecht, Wachtstrasse 2, 6315 Morgarten
Designer: Jean-Luc Thuliez, La Neuveville
Mandataire: Cabinet Roland Nithardt, Conseils en Propriété Industrielle SA, 1400 Yverdon-les-Bains



10909

Cl. 07-02 **132 601** 20.02.2006
 1 Design – Kaffeemaschine
 Hinterleger: M. Schaerer AG, Gewerbestrasse 15,
 3302 Moosseedorf
 Designer: Thomas Liebe, Thun
 Vertreter: Bovard AG, 3000 Bern 25



1

Cl. 07-02 **132 602** 22.02.2006
 3 design – machine à café
 Déposant: Société des Produits Nestlé SA, 1800 Vevey
 Designer: Christopher Drake, Leicester
 Mandataire: Nestec S.A., 1800 Vevey



FL 60390/1

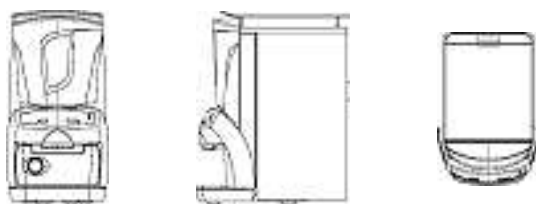

FL 60390/2



FL 60390/3

Cl. 08-05 **132 603** 17.02.2006
 1 Design – Schleiftopf
 Hinterleger: Rosset Technik, Maschinen und Werkzeuge AG,
 Ebersmoos, 6204 Sempach
 Designer: Ralf Sutter, Oberkirch

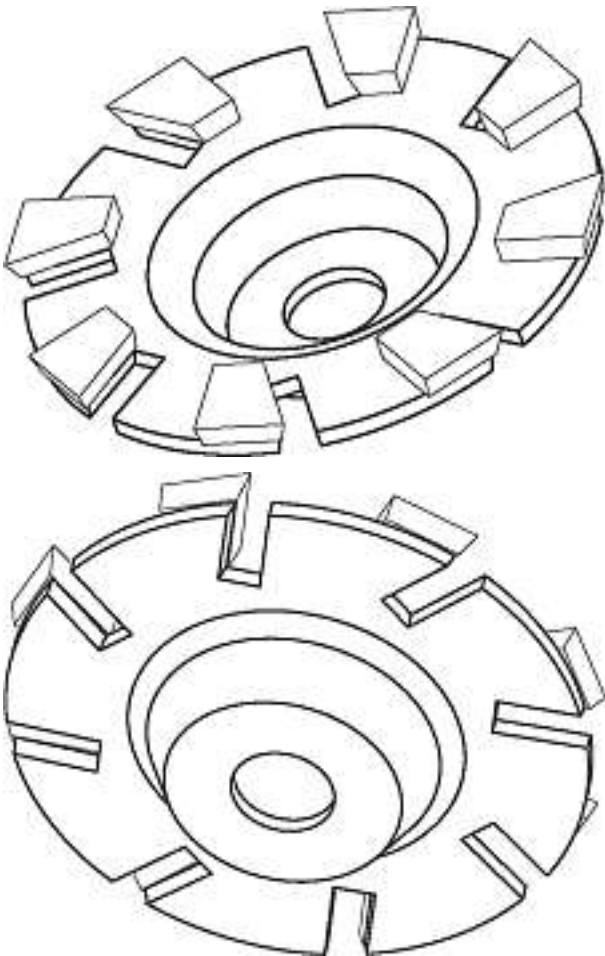

10100

Cl. 08-06 **132 604** 27.02.2006
 4 Design – Werkzeuggriffe
 Hinterleger: Kunststoffwerk AG Buchs, Rheinaustrasse 7,
 9470 Buchs SG
 Designer: Volker Lehmann, Schonach
 Vertreter: Troesch Scheidegger Werner AG, Patent- und
 Markenanwälte, 8126 Zumikon

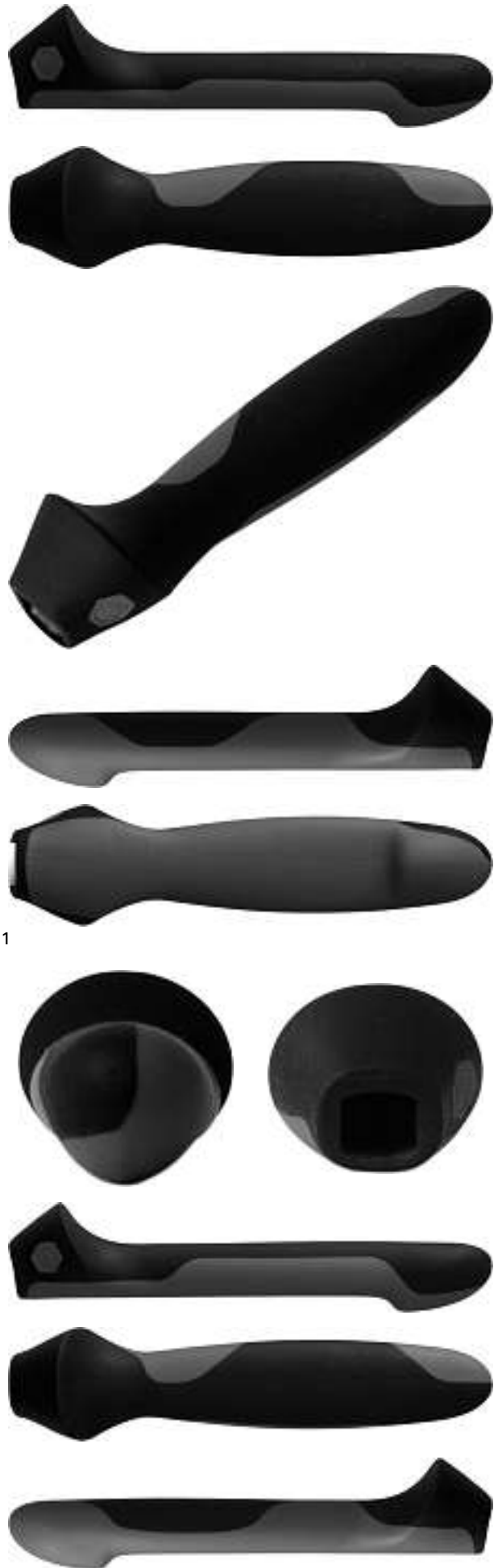



2

3



4

Cl. 09-01 132 605 23.02.2006
 1 design – bouteille
 Déposant: Sources Minérales Henniez S.A., 1525 Henniez
 Designer: Olivier Charrière, Henniez
 Mandataire: Bugnion S.A., 1211 Genève 12 - Champel

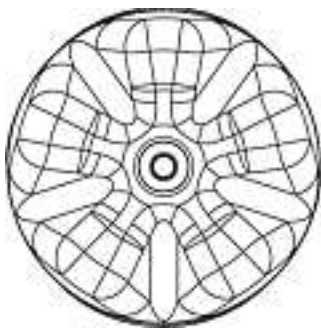
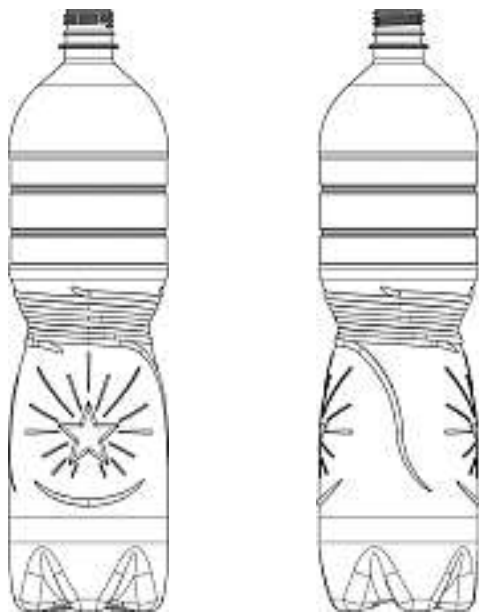

1

Cl. 09-01 **132 606** 17.03.2006
 1 design – bouteille
 Déposant: Société des Produits Nestlé SA, 1800 Vevey
 Designer: Gerd Schwarz, Munich
 Mandataire: Nestec S.A., 1800 Vevey

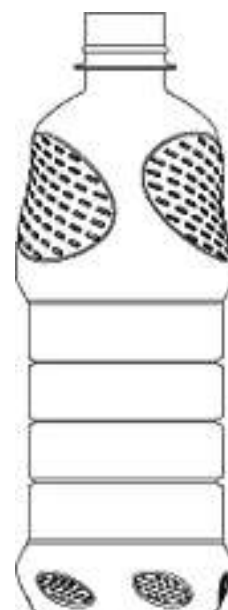
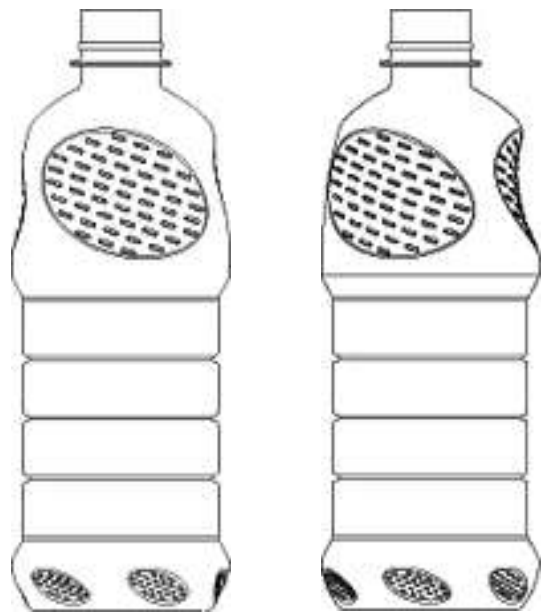
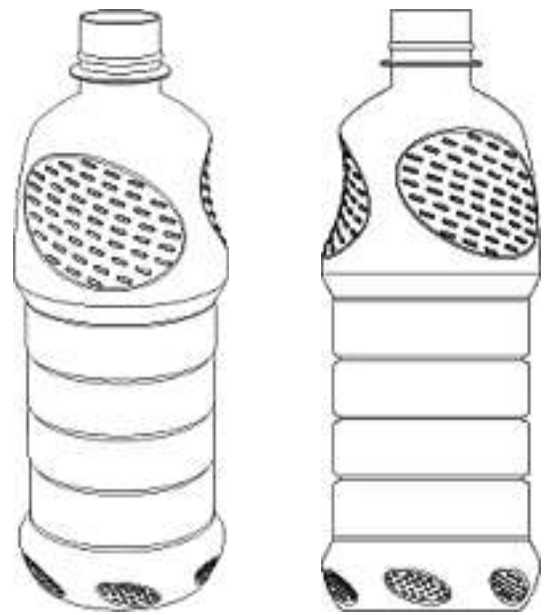

FL 60803

Cl. 10-02 132 607 22.02.2006
 2 design – montres
 Déposant: Alexis Garin, Vy-Perroud 241, 2126 Les Verrières
 Mandataire: Soprintel S.A., 2300 La Chaux-de-Fonds



1

2

Cl. 10-07 132 608 30.01.2006
 1 design – montre
 Déposant: Walter Schlup, Av. Léopold-Robert 13, BP 1381,
 2301 La Chaux-de-Fonds

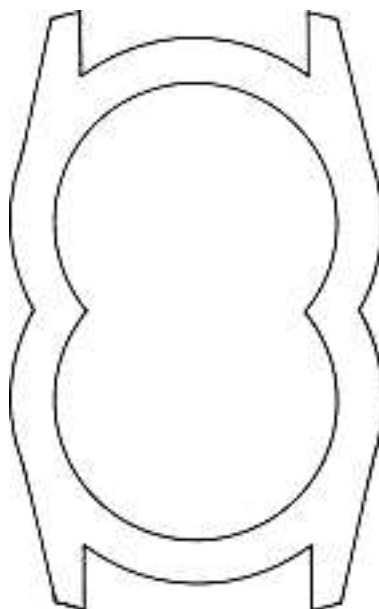
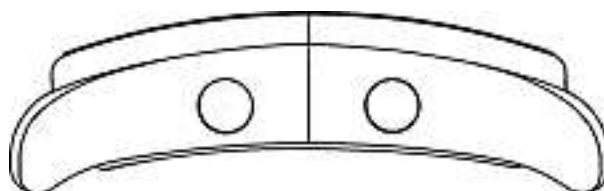
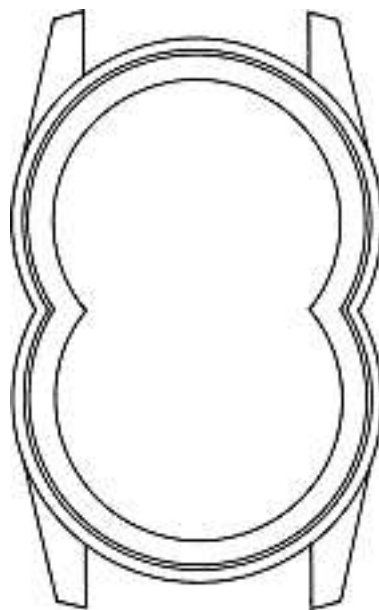

8

Cl. 10-07 132 609 17.02.2006
 7 design – cadrans de montres, boîtiers de montres,
 affichage (décor) pour cadran de montre et boîtier de montre
 avec cadran
 Déposant: de Grisogono S.A., 176bis, Route de Saint-Julien,
 1228 Plan-les-Ouates
 Designer: Fawaz Gruosi, Prangins
 Mandataire: Griffes Consulting S.A., 1206 Genève

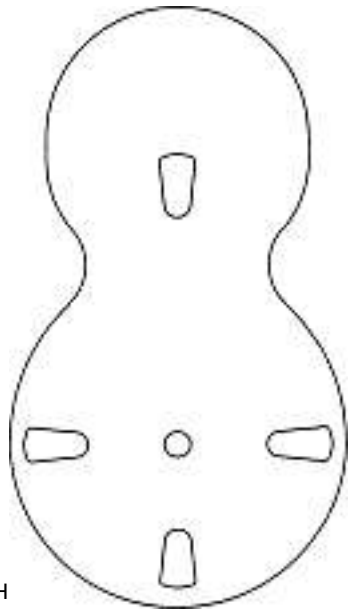

MO-28760-CH

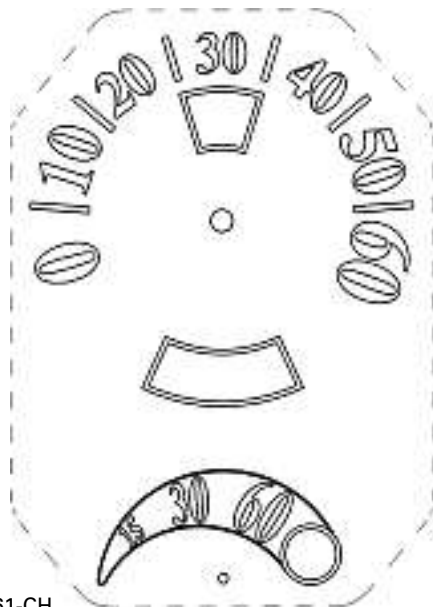

MO-28761-CH

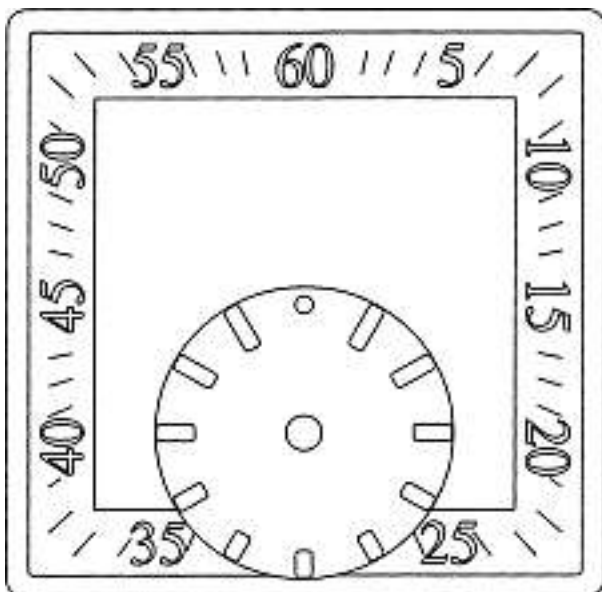

MO-28762-CH

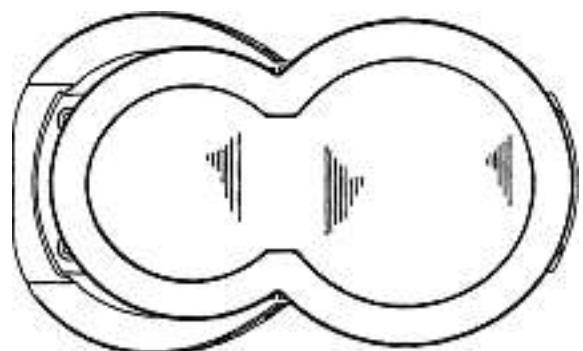
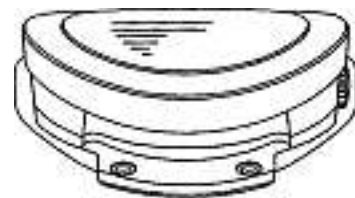
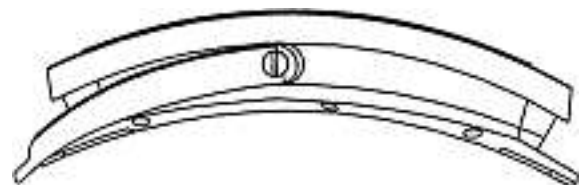
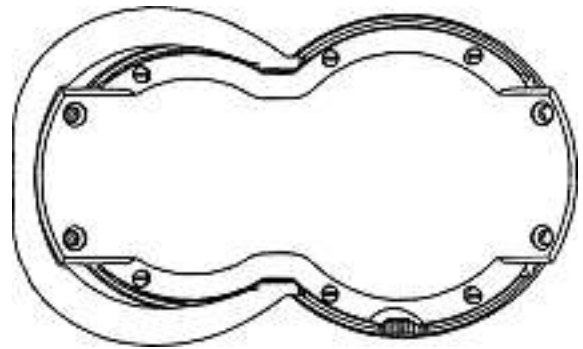
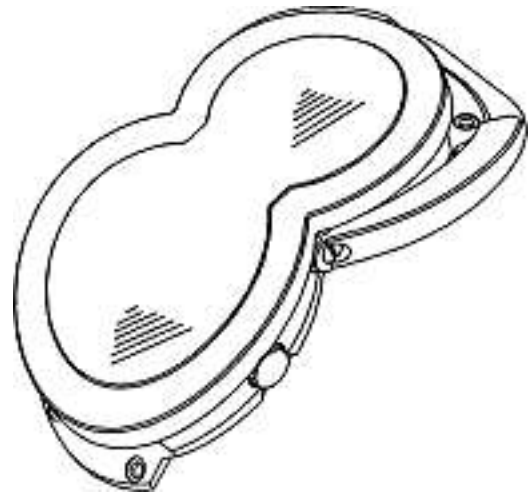
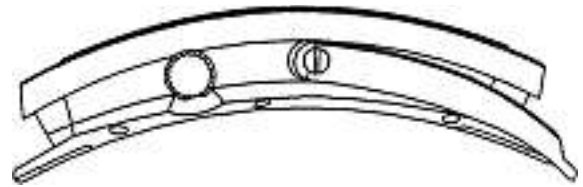

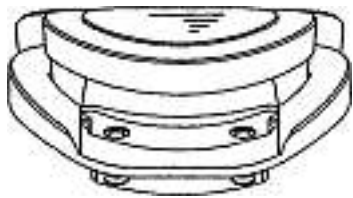

MO-28763-CH



MO-28764-CH

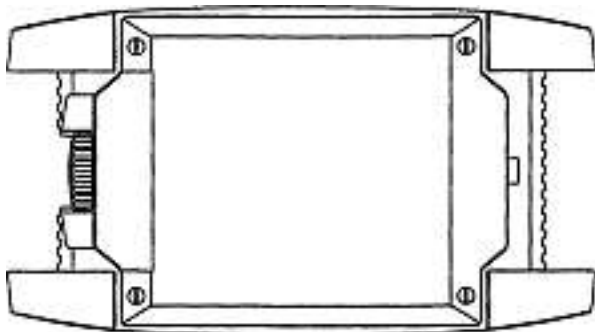

MO-28765-CH

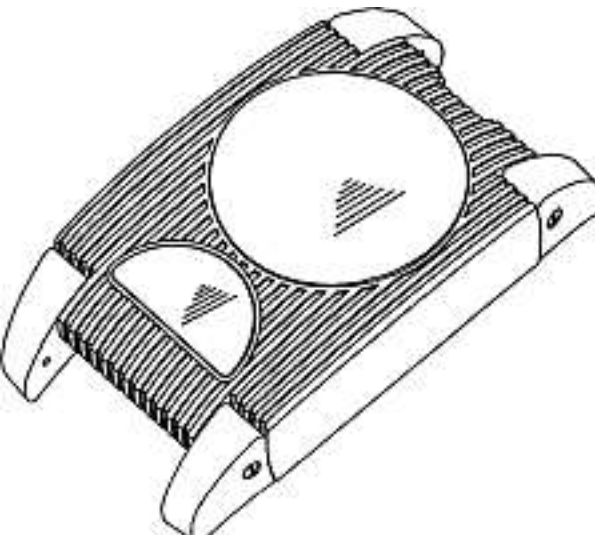
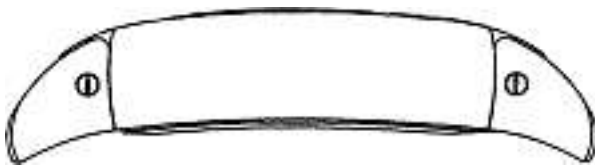

MO-28770-CH

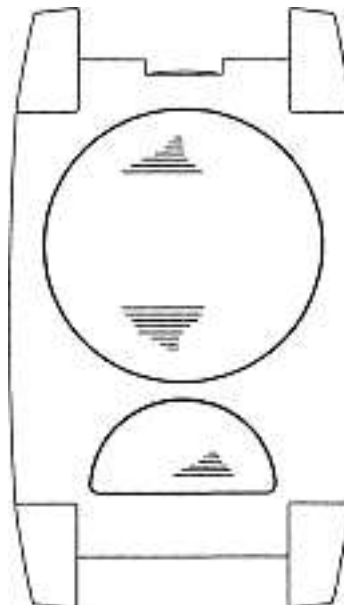
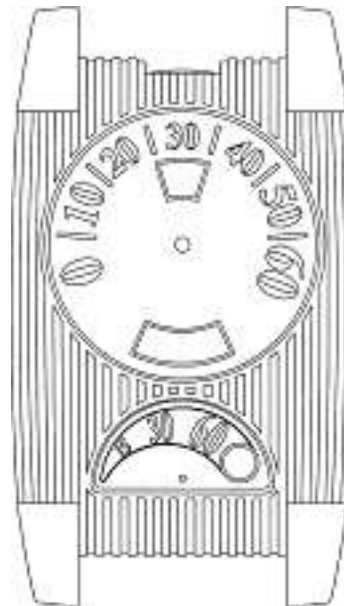
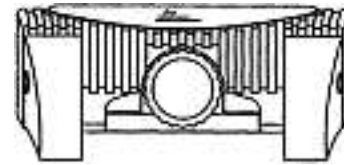
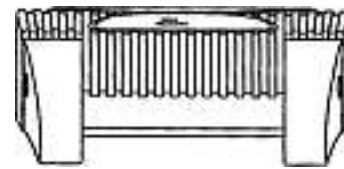
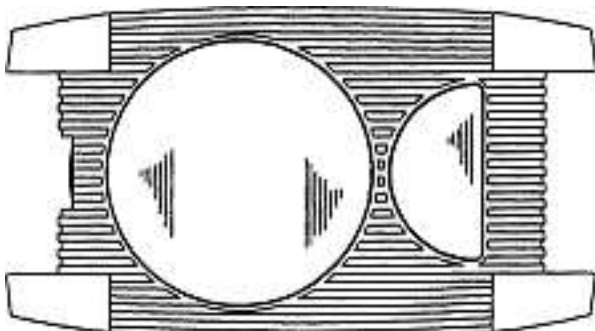

Cl. 11-01 **132 610** 15.02.2006
 5 Design – Schmuckstücke
 Hinterleger: Meister + Co AG, Hauptstrasse 66, 8832 Wollerau
 Designer: Silvio Daldini, Kilchberg ZH; Thomas Geiser, Schübelbach; Dieter Flehmer, Unteriberg; Marcus Siessegger, Wald

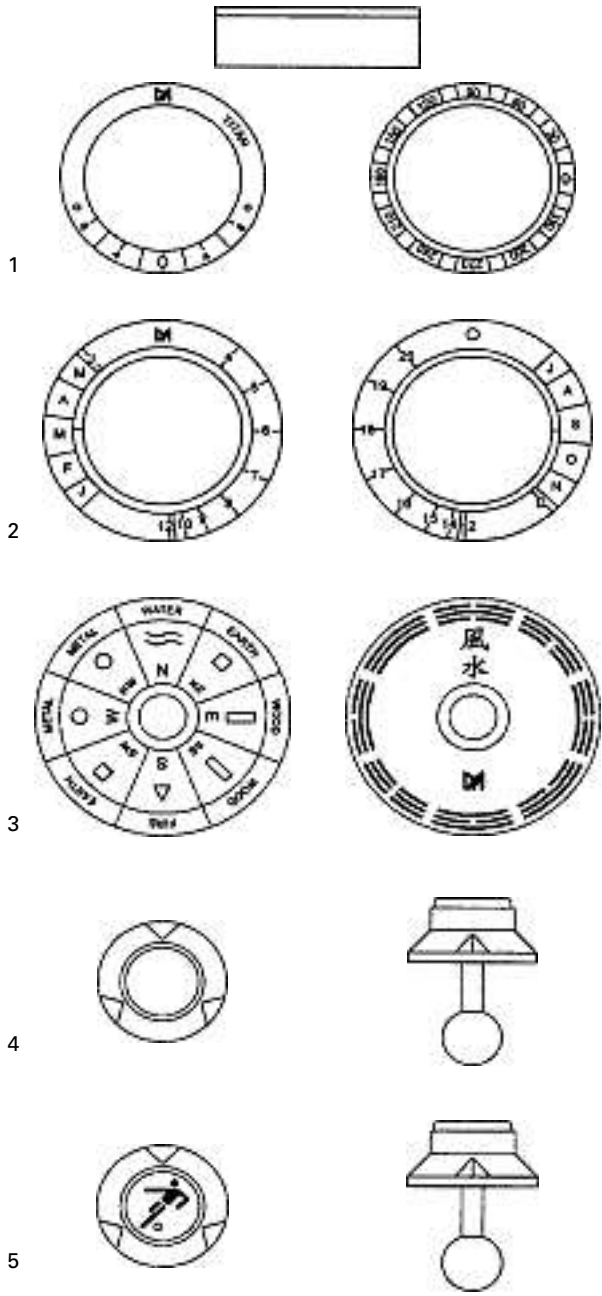

Cl. 11-01 **132 611** 21.02.2006
 1 design – bague
 Déposant: Georges Faulon, Ste Cécile 1, 1217 Meyrin
 Mandataire: Bernard Lachenal et Nadine Maier Viñas, 1204 Genève
 Description du design: bague munie d'un mécanisme de rotation



1

Cl. 12-16 **132 612** 08.02.2006
 2 Design – Luftfiltergehäuse
 Hinterleger: Stefan Beckmüller, Oberdorfstrasse 16, 5443 Niederrohrdorf



Rocket



Bullet

Cl. 15-05 **132 615** 17.02.2006
 1 Design – Staubsaugerroboter mit Ladestation
 Hinterleger: BSH Bosch und Siemens Hausgeräte GmbH, Carl-Wery-Strasse 34, München, DE
 Designer: Jörg Schröter, Gröbenzell
 Vertreter: Isler & Pedrazzini AG, 8023 Zürich
 Priorität: EM, 29.08.2005



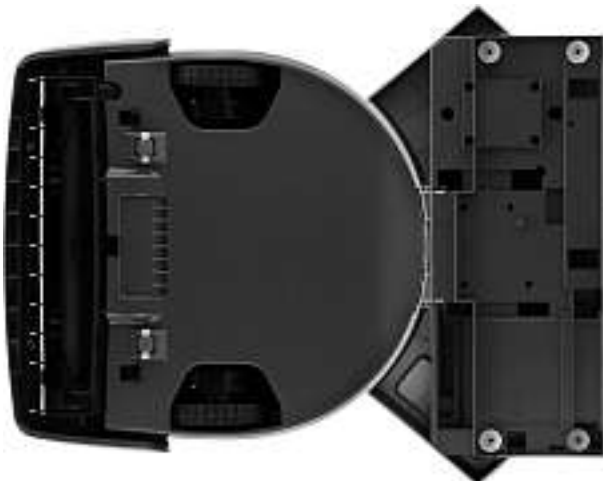

M13130

Cl. 18-01 132 616 17.02.2006
 4 Design – Registrierkassen
 Hinterleger: Fujitsu Limited, 1-1, Kamikodanaka 4-chome,
 Nakahara-ku, Kawasaki-shi, Kanagawa 211-8588, JP
 Designer: Taku Ando, Kanagawa; Toshiyuki Ichikawa, Tokyo;
 Youhei Shimura, Tokyo
 Vertreter: Bovard AG, 3000 Bern 25
 Priorität: JP, 19.08.2005; JP, 19.08.2005; JP, 30.01.2006;
 JP, 30.01.2006

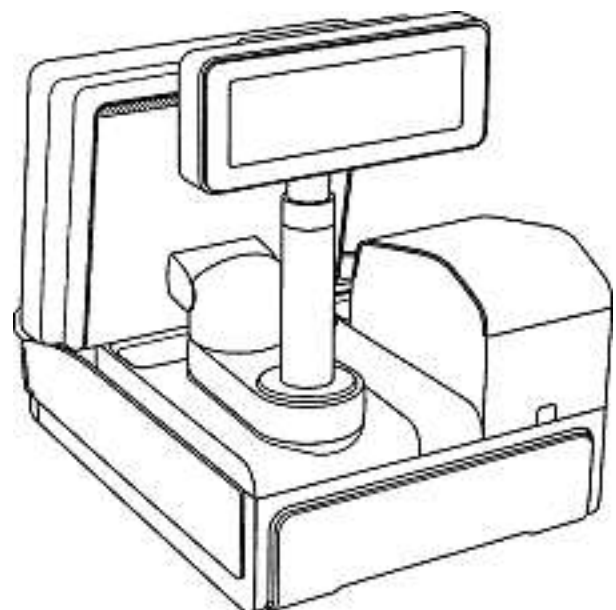
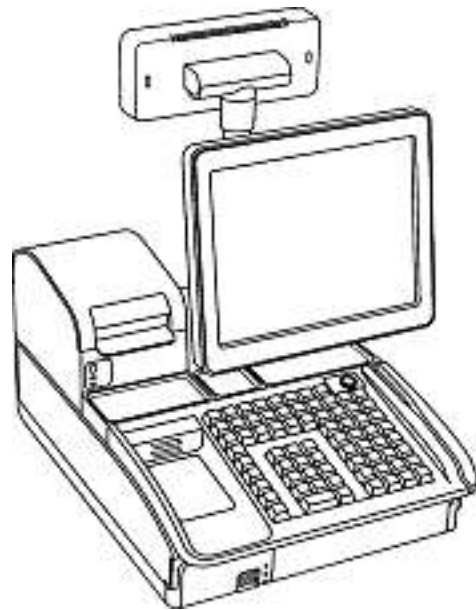

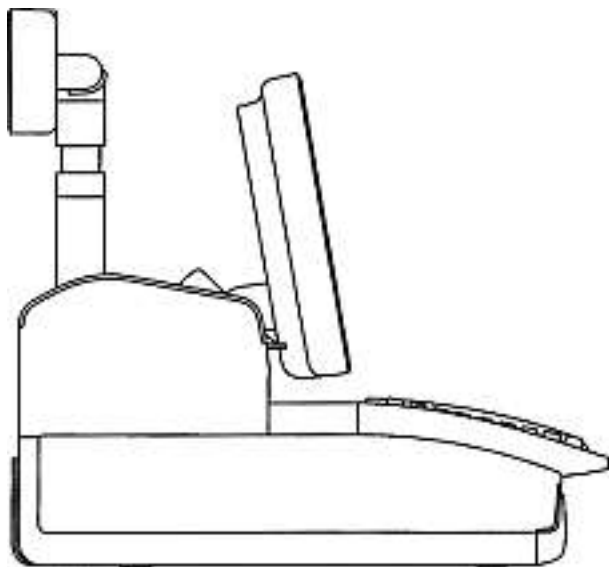
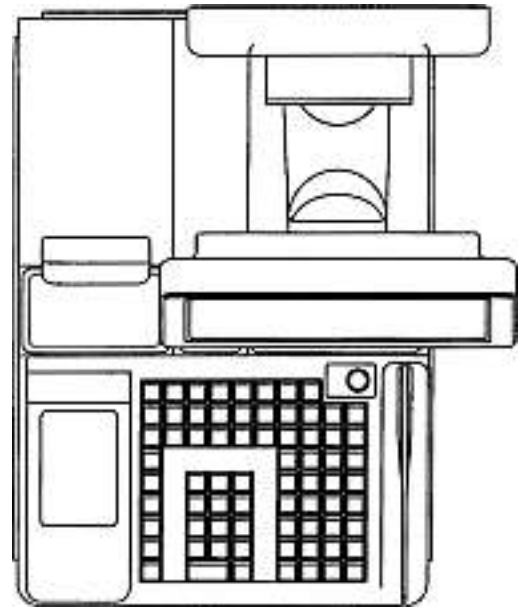
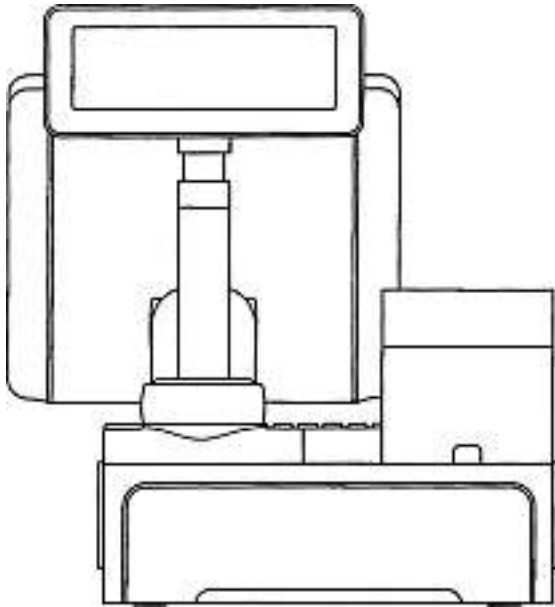
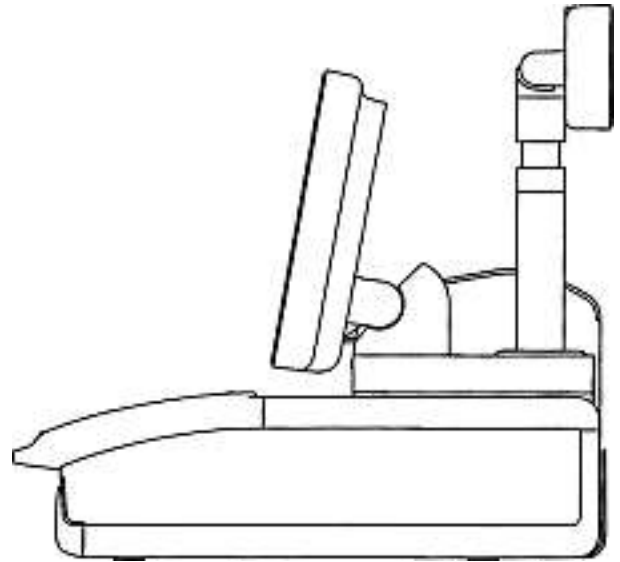
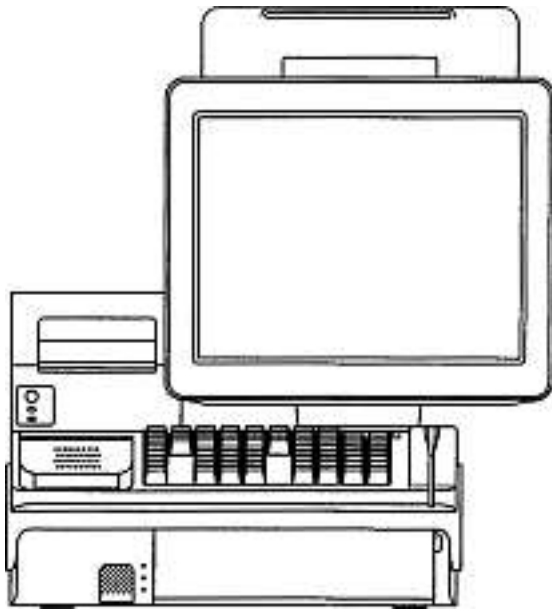

1

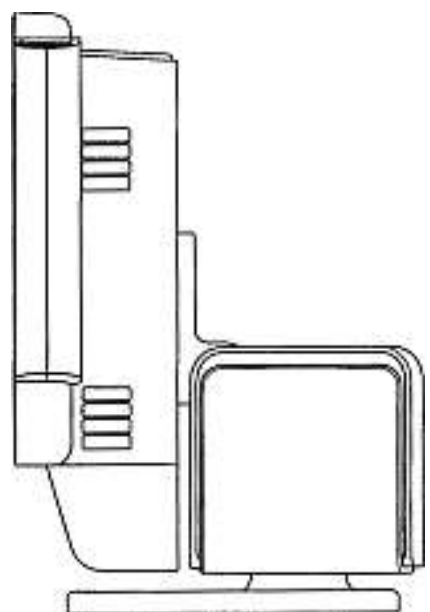
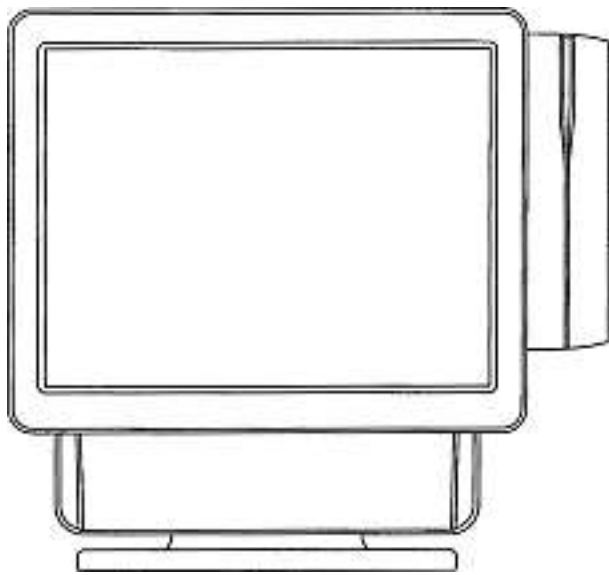
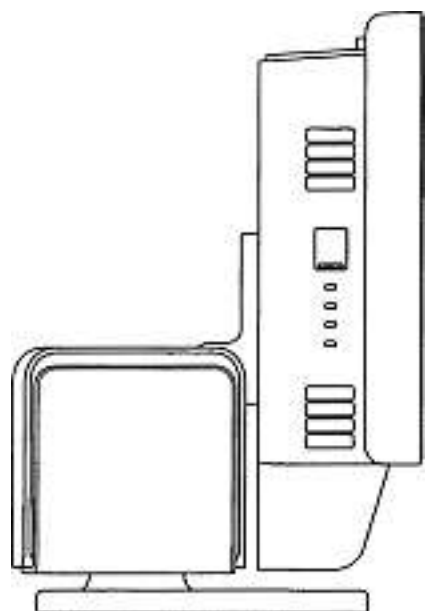
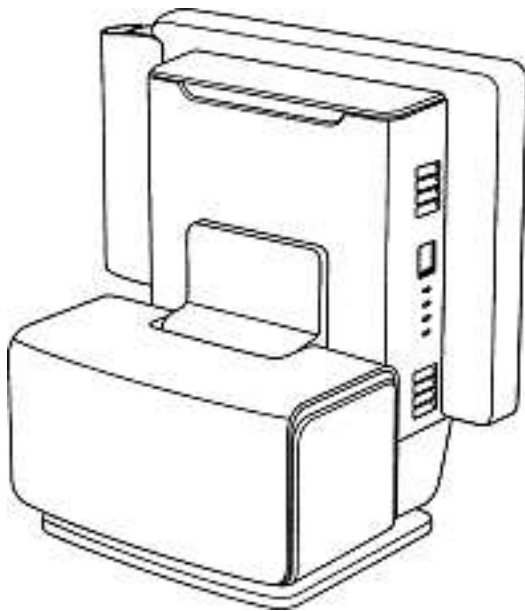
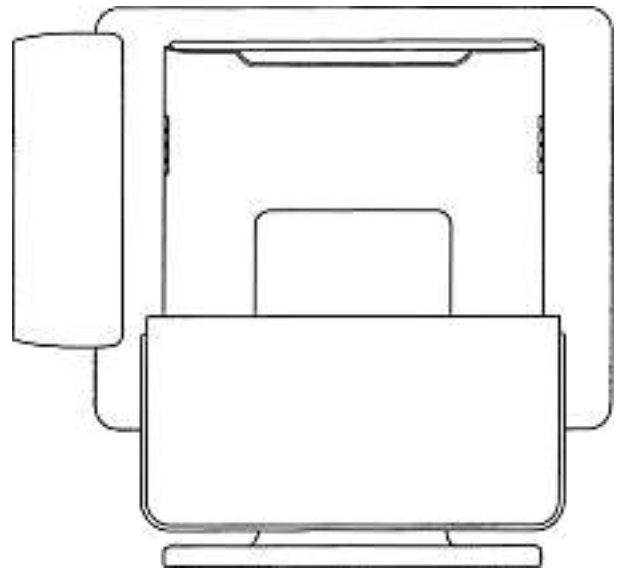
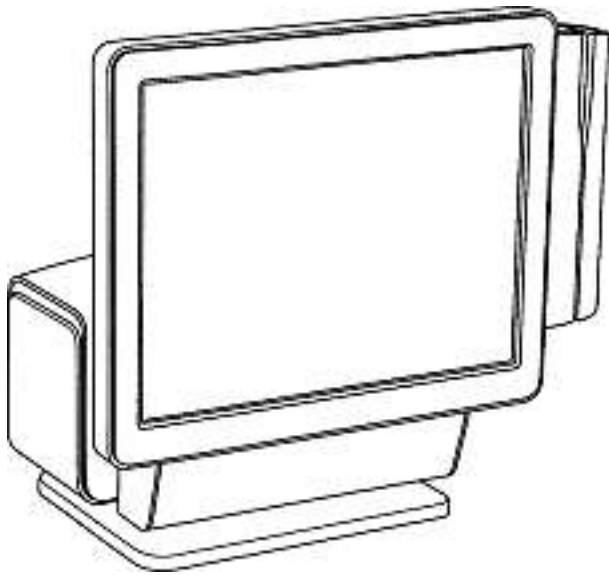

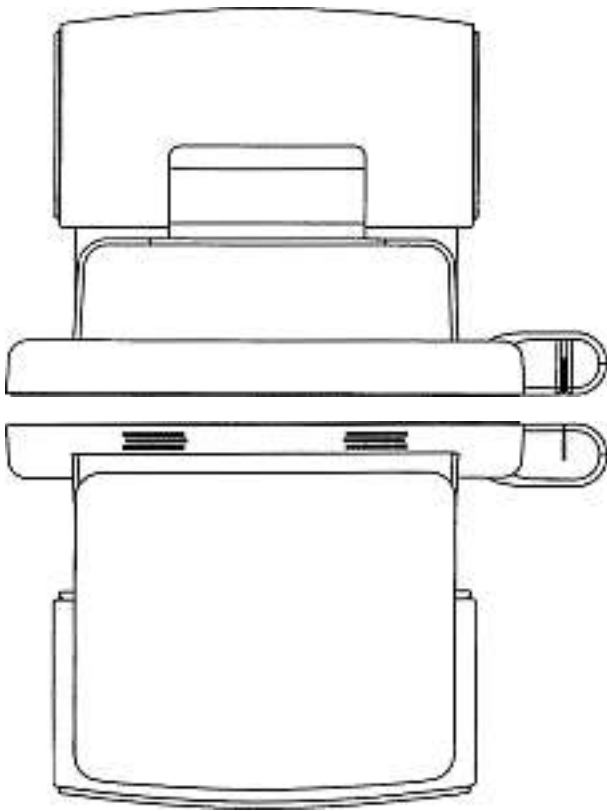

2

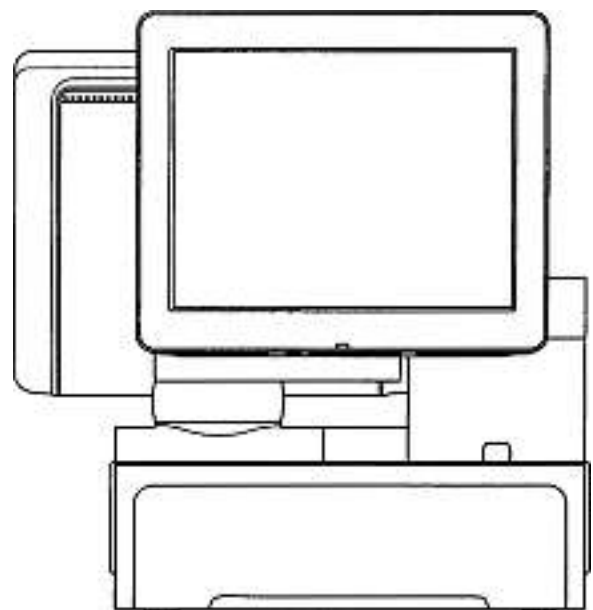
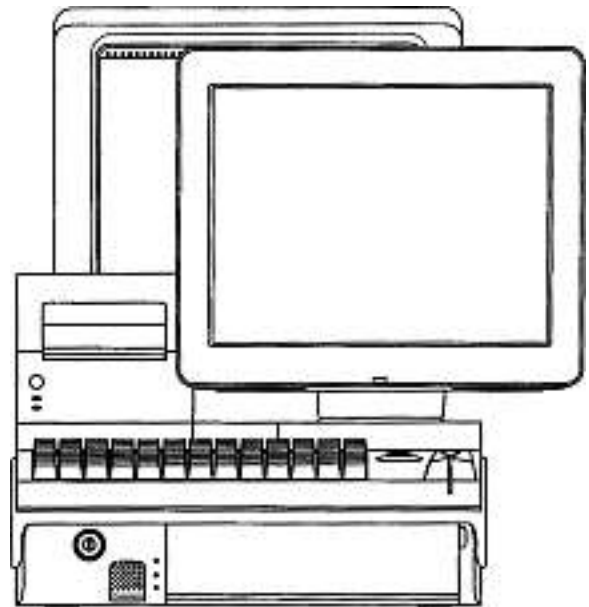
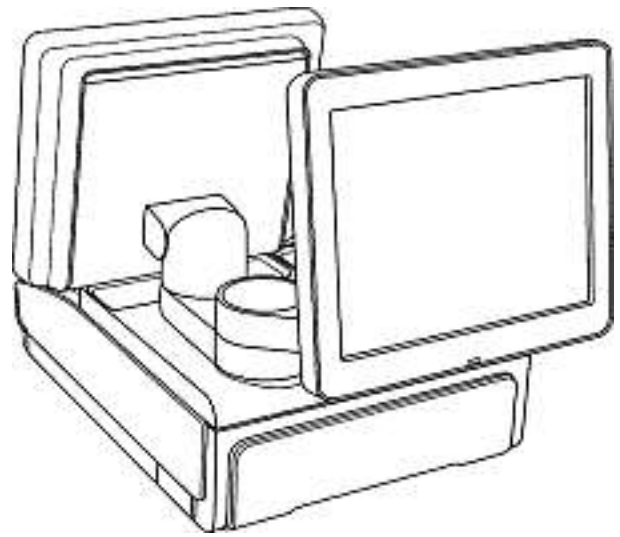
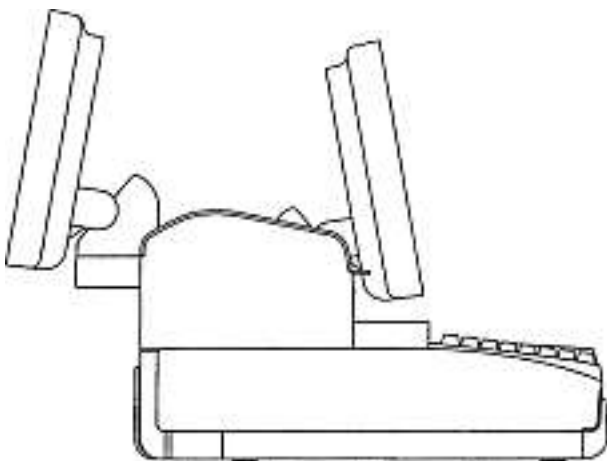

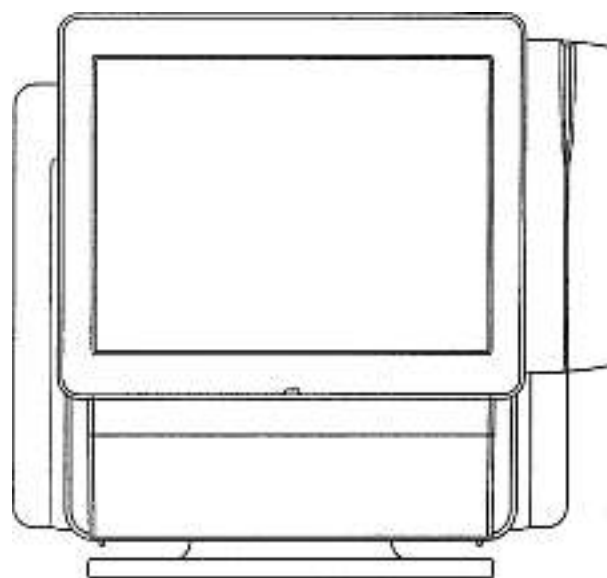
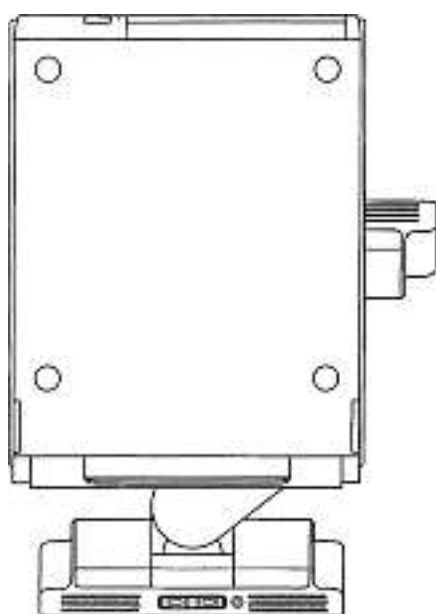
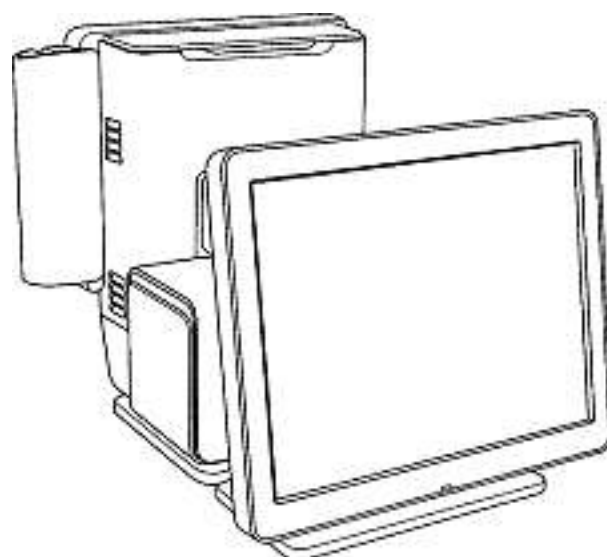
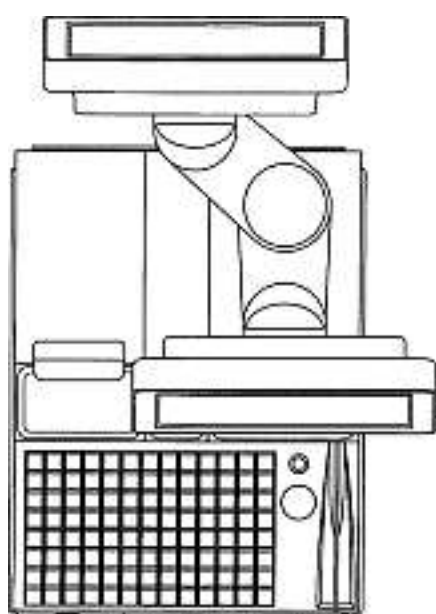
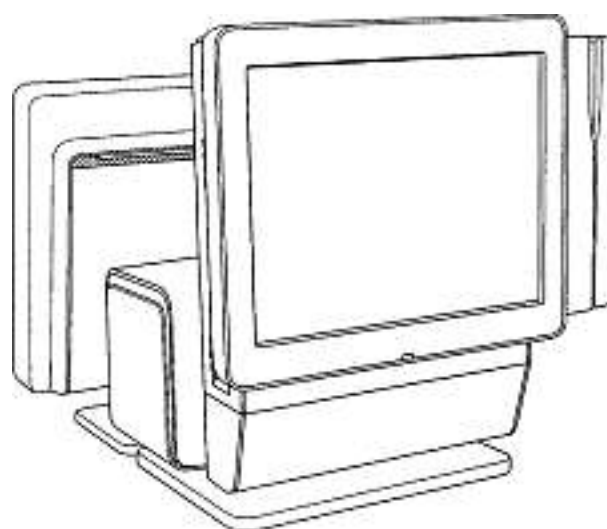
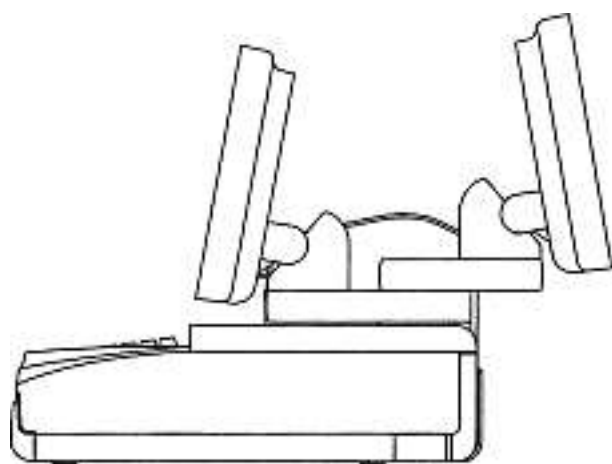

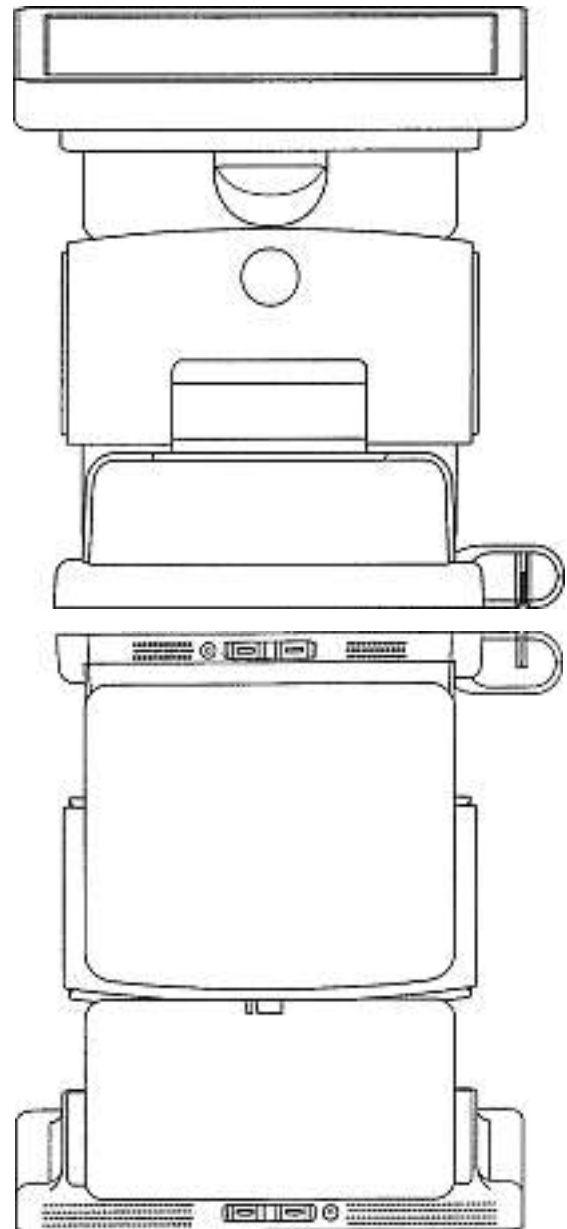
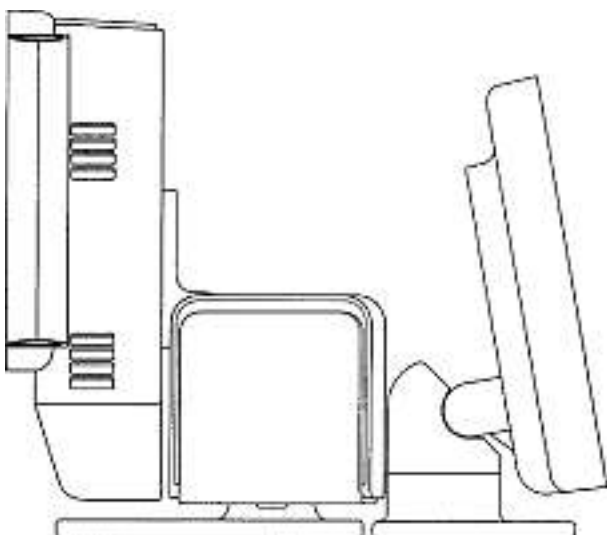
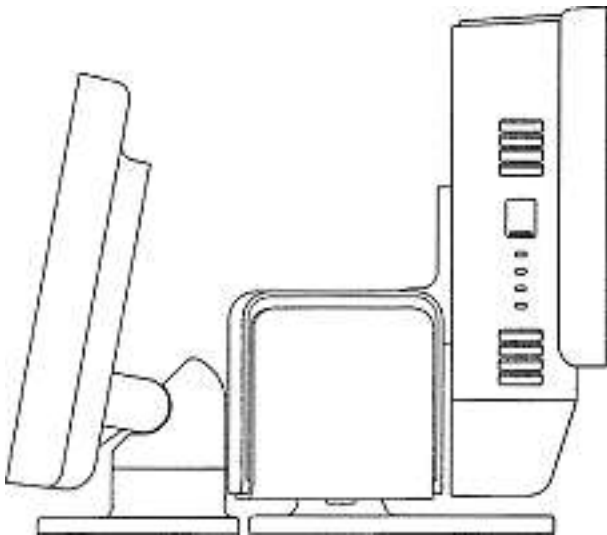
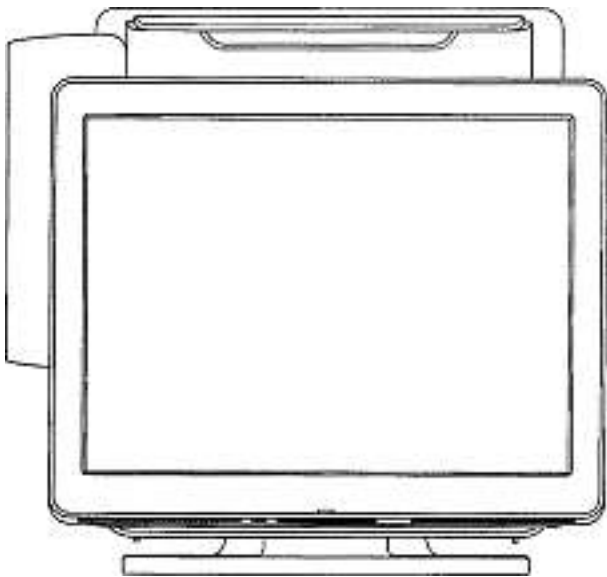

4

Cl. 20-03 132 617 31.01.2006

3 Design – Werbebanner
Hinterleger: novi-marketing Günter Koch, Jungfernstieg 1,
Worpswede, DE

Designer: Günter Koch, Worpswede

Vertreter: R. A. Egli & Co., Patentanwälte, 8008 Zürich

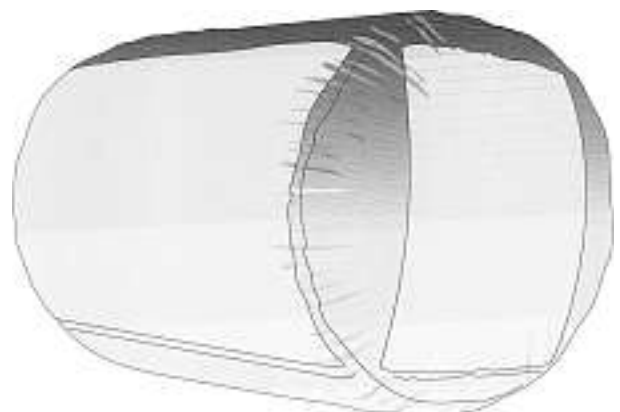

1

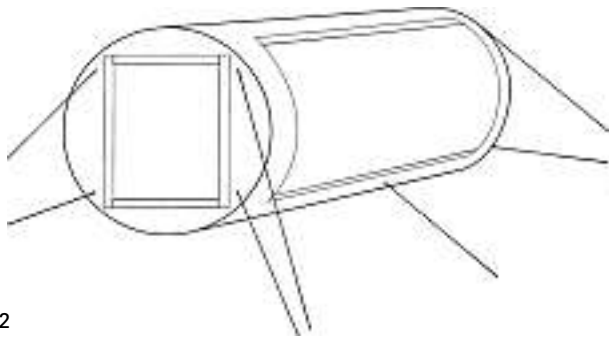

2

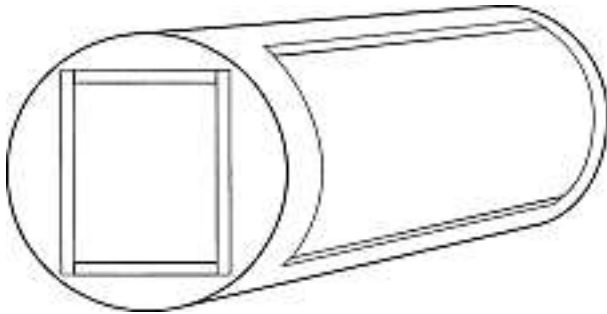

3

Cl. 21-01 132 618 09.02.2006
 1 design – poupée
 Déposant: Birgitta Bischoff, rue du Léman 12, 1800 Vevey



Fredyboy

Cl. 21-02 132 619 26.01.2006
 2 Design – Ski, Skizubehör
 Hinterleger: Ulrich Gertsch, Ziegeleistrasse 32c, Postfach 54,
 3612 Steffisburg

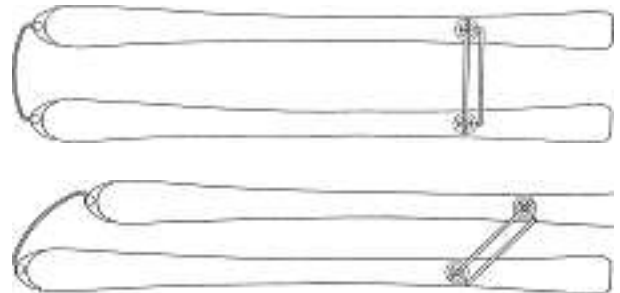

260 126 A

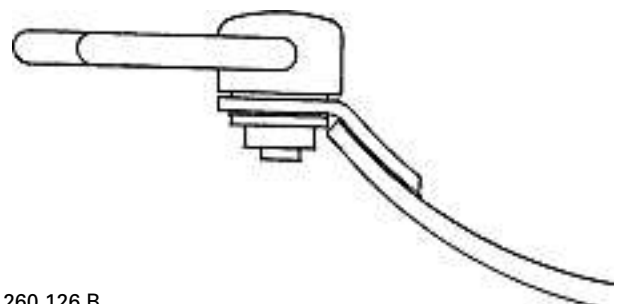

260 126 B

Cl. 23-04 132 620 07.02.2006
 2 Design – Ventilator
 Hinterleger: formanek.ch, Bürenweg 5/7, 4500 Solothurn
 Designer: Karel Formánek, Solothurn
 Vertreter: Karel Formánek, 4500 Solothurn

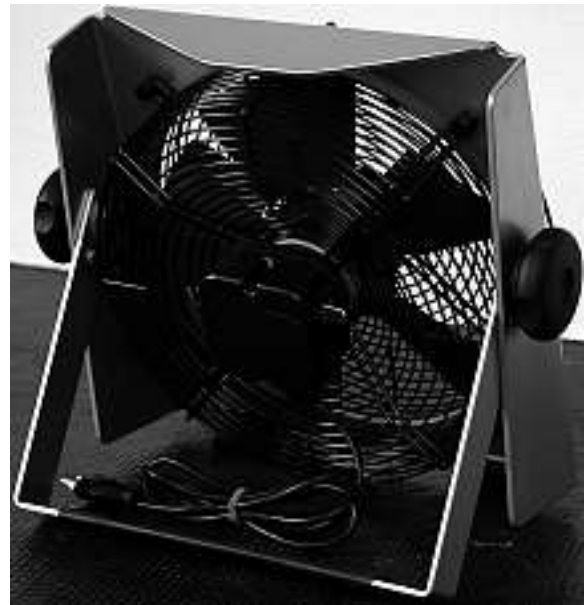

06002 «B2» mit Griff



06001 «AirBag»

Cl. 24-02 132 621 10.02.2006
 1 design – boîte de Pétri
 Déposant: bioMérieux, Chemin de l'Orme, 69280 Marcy
 L'Etoile, FR
 Designer: Stéphane Chianea, Saint Maurice de Beynost
 Mandataire: Kirker & Cie S.A., Ingénieurs-Conseils,
 1226 Genève - Thônex
 Priorité: EM, 12.08.2005

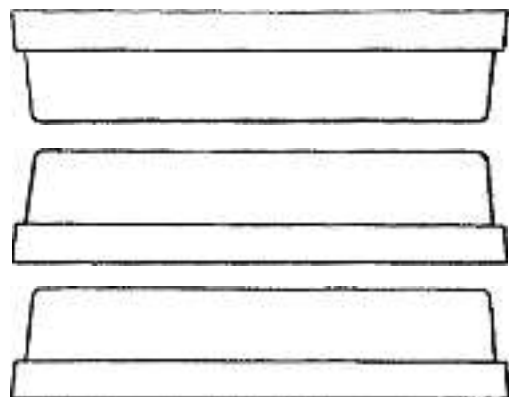

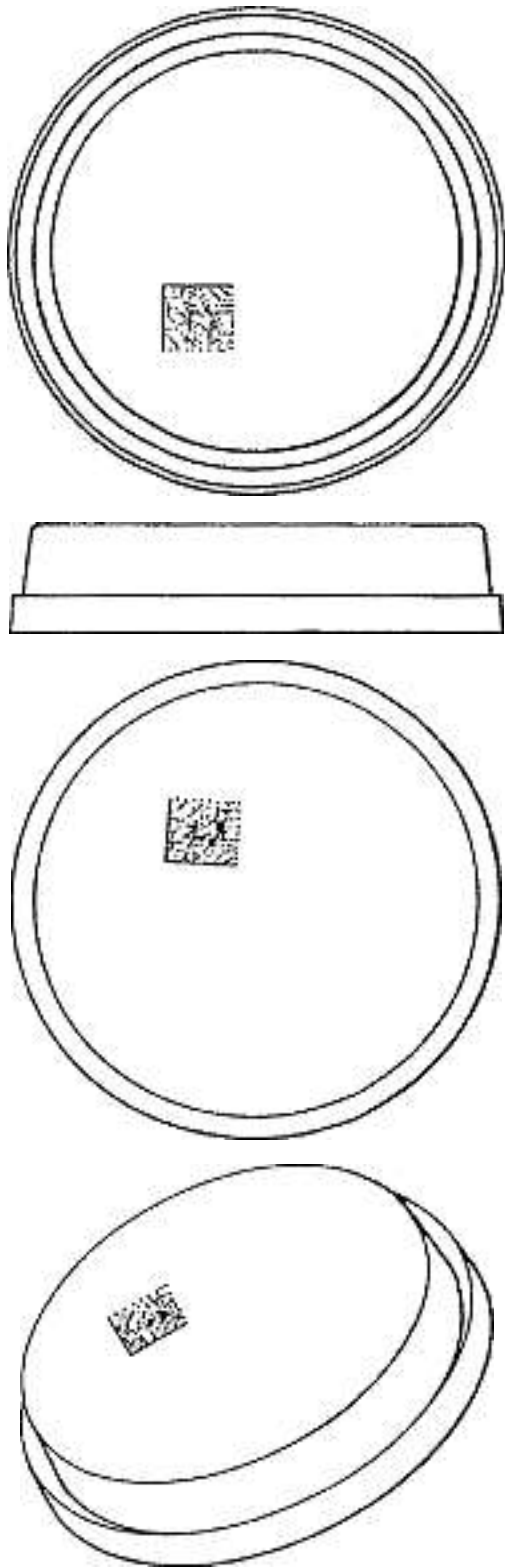

MPM/ci/310101-CH

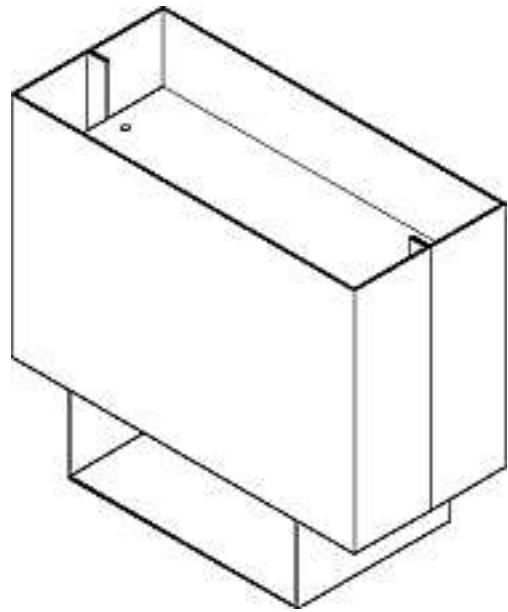

1

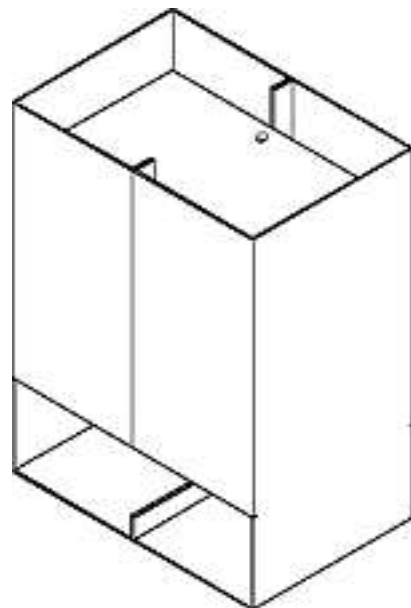

Cl. 26-05 132 622 23.02.2006
 2 Design – Lampe
 Hinterleger: e15 Design und Distributions GmbH,
 Hospitalstrasse 4, Oberursel, DE
 Designer: Mark Holmes, London
 Vertreter: Luchs & Partner, Patentanwälte, 8002 Zürich
 Priorität: EM, 25.08.2005



2



1



Cl. 30-02 132 623 22.02.2006
 4 Design – Vogelhaus
 Hinterleger: Günter Brötzmann, Kleinhartbach 9, Uffenheim, DE
 Vertreter: Schneider Feldmann AG, Patent- und
 Markenanwälte, 8039 Zürich
 Priorität: EM, 23.08.2005; EM, 23.08.2005; EM, 23.08.2005;
 EM, 23.08.2005

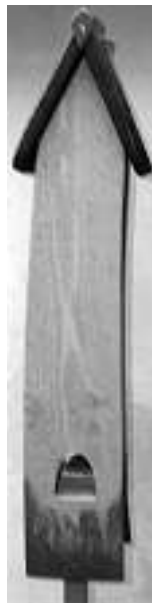

2



3



4

Verlängerungen
Prolongations
Prolongazioni

118 873 Cl. 14-99 1 Design

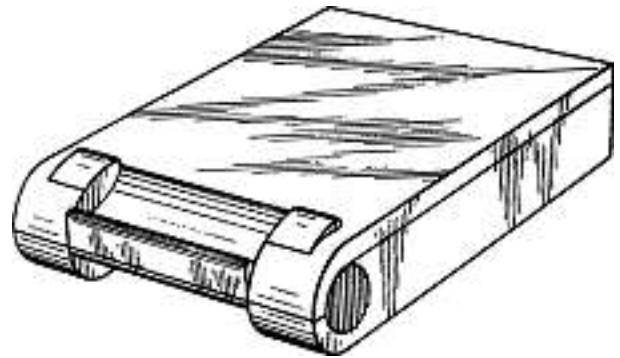
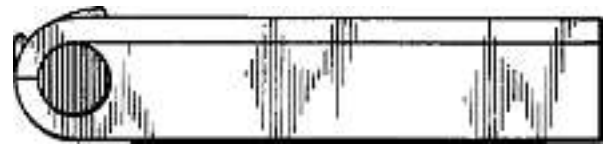
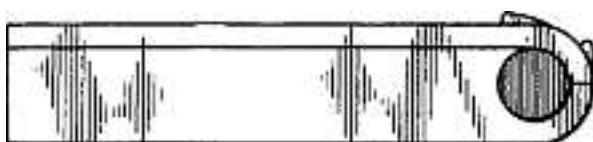
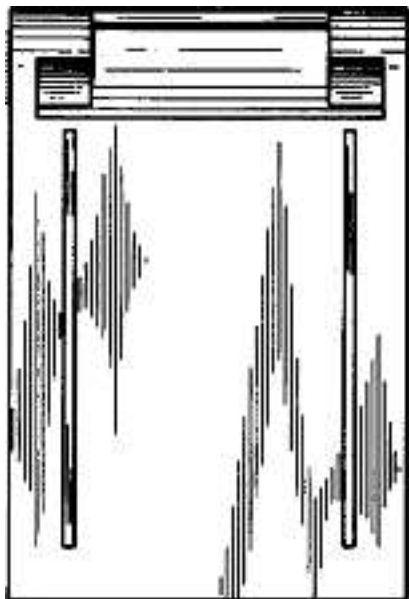
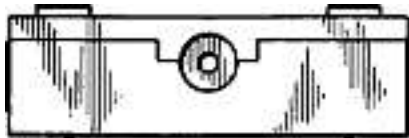

M8253.1

118 982 Cl. 24-04 3 Design

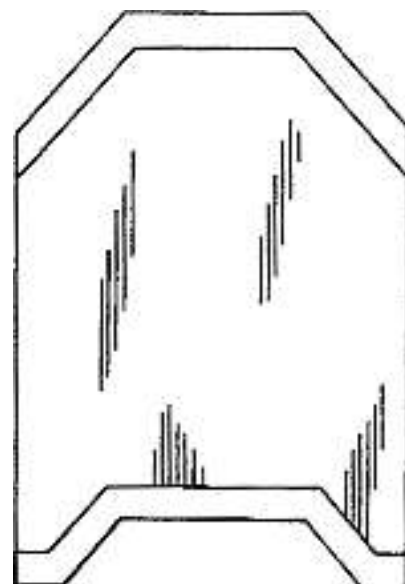
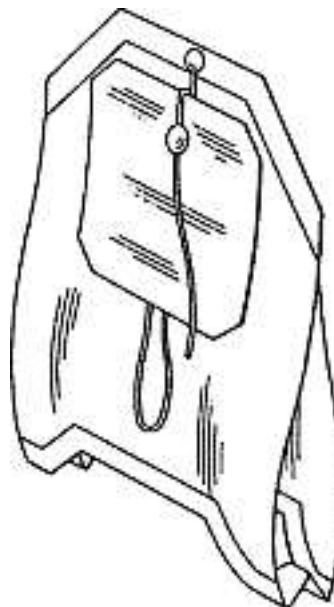

1

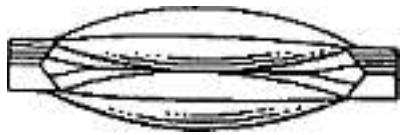
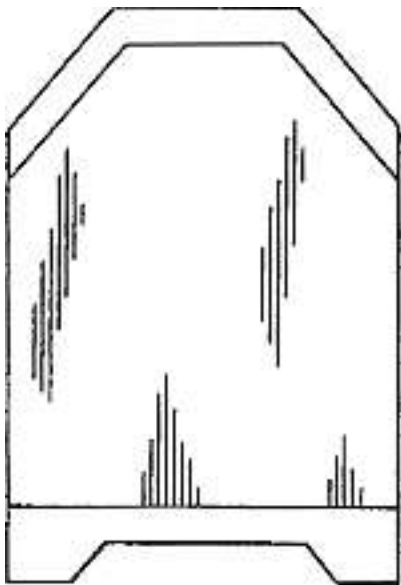
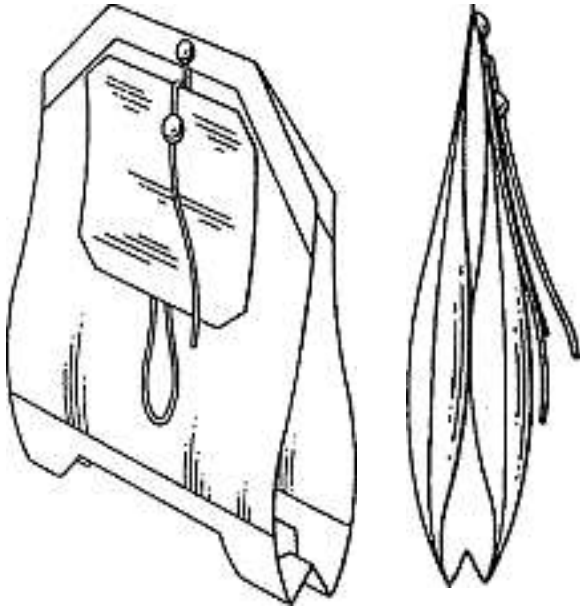
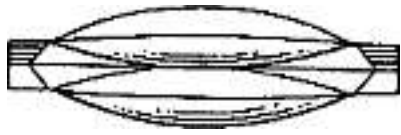

2

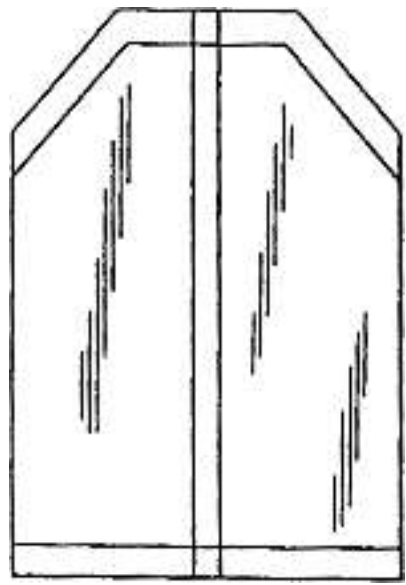
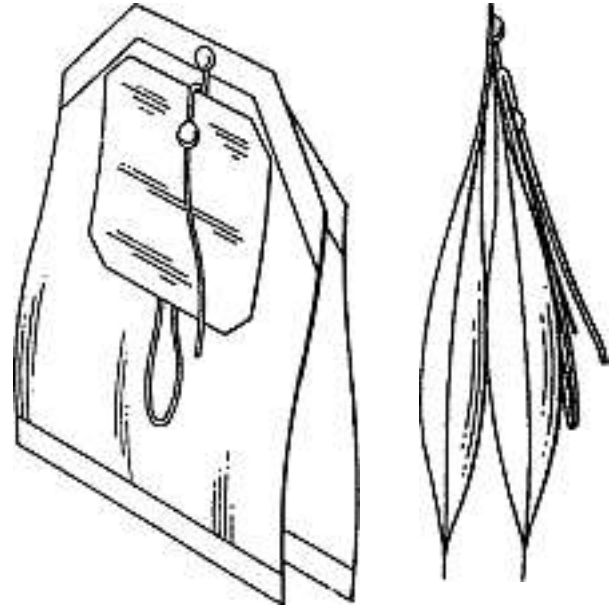

3

119 029 Cl. 20-03 1 Design

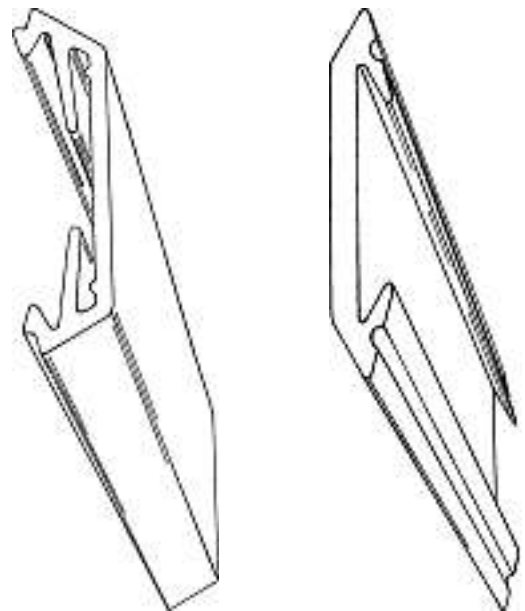

D 272 CH

122 489	Cl.	14-02	1 Design
123 267	Cl.	25-01	2 Design
123 316	Cl.	16-03	1 Design
123 382	Cl.	06-01	1 Design
123 408	Cl.	25-02	1 Design
123 411	Cl.	99-00	1 Design
123 445	Cl.	10-04	2 Design
123 454	Cl.	15-99	1 Design
123 491	Cl.	15-99	2 Design
123 492	Cl.	15-99	1 Design
127 775	Cl.	02-07	9 Design
127 823	Cl.	06-01	3 Design
127 828	Cl.	06-01	43 Design
127 834	Cl.	07-03	1 design
127 857	Cl.	23-03	1 Design
127 914	Cl.	14-01	2 Design
127 918	Cl.	18-99	2 Design
127 936	Cl.	06-04	4 Design
127 956	Cl.	18-99	2 Design
127 964	Cl.	26-05	1 Design
127 995	Cl.	25-01	1 Design
128 010	Cl.	06-03	1 Design
128 052	Cl.	09-05	1 Design
128 060	Cl.	13-03	25 Design
128 090	Cl.	10-04	3 Design
128 282	Cl.	09-01	1 Design

Löschungen Radiations Radiazioni

118 405	Cl.	23-02	1 Design
118 491	Cl.	19-02	1 Design
118 525	Cl.	14-02	1 Design
122 589	Cl.	04-02	7 Design
122 593	Cl.	06-01	1 Design
122 604	Cl.	09-09	1 Design
122 606	Cl.	10-02	2 design
122 616	Cl.	19-06	1 Design
122 652	Cl.	09-09	1 Design
122 782	Cl.	10-02	1 design
122 801	Cl.	23-04	1 design
127 248	Cl.	06-04	1 Design
127 252	Cl.	07-06	1 Design
127 253	Cl.	07-06	2 Design
127 256	Cl.	09-06	3 Design
127 257	Cl.	09-06	3 Design
127 266	Cl.	15-09	1 Design
127 269	Cl.	21-01	1 design
127 278	Cl.	06-03	1 Design
127 279	Cl.	06-04	1 Design
127 284	Cl.	08-08	2 Design
127 286	Cl.	09-01	1 Design
127 288	Cl.	09-03	13 Design
127 290	Cl.	10-02	1 design
127 291	Cl.	10-03	2 Design
127 296	Cl.	11-02	4 Design
127 302	Cl.	21-01	1 Design
127 305	Cl.	21-03	1 Design
127 309	Cl.	24-04	2 Design
127 312	Cl.	25-02	1 Design
127 313	Cl.	27-05	1 design
127 314	Cl.	28-03	1 design
127 315	Cl.	28-03	1 design
127 354	Cl.	06-01	1 Design
127 379	Cl.	11-02	1 Design
127 463	Cl.	10-02	1 Design
127 469	Cl.	11-02	2 design
127 488	Cl.	27-05	6 design
127 489	Cl.	27-05	1 design
127 522	Cl.	26-05	3 Design

Mutationen Modifications Modificazioni

122 489

Neuer Vertreter

Vertreter: Luchs & Partner, Patentanwälte, 8002 Zürich

123 405

Neuer Vertreter

Vertreter: Industrierberatung Maier AG, 4450 Sissach

128 052

Neuer Vertreter

Vertreter: Schneider Feldmann AG, Patent- und
Markenanwälte, 8039 Zürich

128 090

Namensänderung

Hinterleger: Bayer (Schweiz) AG, Zweigniederlassung
Division Zeptosens, Benkenstrasse 254, 4108 Witterswil

132 002

Nouveau mandataire

Mandataire: Cabinet Roland Nithardt, Conseils en Propriété
Industrielle SA, 1400 Yverdon-les-Bains

132 433

nachträglicher Designereintrag

Designer: Klaus Bähr, Michelstadt