

Nationale Hinterlegungen

In der folgenden Liste werden die beim Eidgenössischen Institut für Geistiges Eigentum hinterlegten Designs publiziert. Dabei sind der Reihe nach angegeben:

- internationale Klassenangaben
- Hinterlegungsnummer
- Hinterlegungsdatum
- Allenfalls Aufschub der Veröffentlichung
- Anzahl der hinterlegten Designs
- Bezeichnung
- Name und Wohnsitz des Hinterlegers oder der Hinterlegerin
- gegebenenfalls Name und Wohnsitz des Designers oder der Designerin
- Name und Geschäftssitz des allfälligen Vertreters oder der Vertreterin
- gegebenenfalls Prioritätsangaben
- gegebenenfalls Beschreibungstext
- Ordnungsnummer
- Reproduktion des Designs

Internationale Hinterlegungen

Die bei der Weltorganisation für geistiges Eigentum in Genf hinterlegten Muster und Modelle mit Benennung Schweiz geniessen den gleichen Schutz wie national hinterlegte Designs. Sie werden jeweils im Blatt «Bulletin des dessins et modèles internationaux» veröffentlicht. Dieses Publikationsorgan ist deshalb für eine vollständige Recherche unbedingt beizuziehen.

Topographien

Angaben über die vom Eidgenössischen Institut für Geistiges Eigentum eingetragenen Topographien von Halbleitererzeugnissen werden in folgender Anordnung aufgeführt:

- Eintragsnummer
- Anmeldedatum
- Bezeichnung
- Name und Wohnsitz des Anmelders oder der Anmelderin
- gegebenenfalls Name und Wohnsitz des Herstellers oder der Herstellerin
- Name und Geschäftssitz des oder der allfälligen Bevollmächtigten
- Datum und Ort einer allfälligen ersten geschäftlichen Verbreitung der Topographie

Dépôts nationaux

Les designs déposés à l'Institut Fédéral de la Propriété Intellectuelle sont publiés dans la liste qui suit. Les indications y relatives sont mentionnées dans cet ordre:

- indications des classes internationales
- numéro de dépôt
- date de dépôt
- le cas échéant, ajournement de la publication
- nombre des designs déposés
- désignation
- nom et domicile du/de la déposant/e
- le cas échéant, nom et domicile du/de la designer
- nom et domicile de l'éventuel/le mandataire
- le cas échéant, indication de priorité
- le cas échéant, description du design
- numéro attribué à chaque design
- reproduction du design

Dépôts internationaux

Les dessins et modèles déposés à l'Organisation Mondiale de la Propriété Intellectuelle à Genève qui désignent la Suisse jouissent de la même protection que les dépôts nationaux. Ils sont chaque fois publiés dans la feuille «Bulletin des dessins et modèles internationaux». Pour une recherche complète, il est indispensable de consulter ledit organe de publication.

Topographies

Les indications concernant les topographies des produits semi-conducteurs, enregistrées par l'Institut Fédéral de la Propriété Intellectuelle, sont énumérées dans l'ordre suivant:

- numéro d'enregistrement
- date de dépôt
- désignation
- nom et domicile du/de la déposant/e
- le cas échéant, nom et domicile du/de la producteur/trice
- nom et domicile de l'éventuel/le mandataire
- date et lieu d'une éventuelle première mise en circulation de la topographie

Depositi nazionali

Nella lista seguente vengono pubblicati i design depositati presso l'Istituto Federale della Proprietà Intellettuale. Sono menzionati nel seguente ordine:

- indicazioni delle classi internazionali
- numero di deposito
- data del deposito
- se del caso, indicazione che la pubblicazione è stata differita
- numero dei design depositati
- designazione
- nome e domicilio del depositante
- se del caso, nome e domicilio del designer
- nome e sede di un eventuale mandatario
- se del caso, indicazioni di priorità
- se del caso, descrizione del design
- numero d'ordine
- riproduzione del design

Depositi internazionali

I disegni e modelli depositati presso l'Organizzazione Mondiale della Proprietà Intellettuale a Ginevra con denominazione Svizzera godono della medesima protezione del deposito nazionale. Essi vengono pubblicati ogni volta nel foglio «Bulletin des dessins et modèles internationaux». Quest'organo di pubblicazione è da consultare se si vuole effettuare una ricerca completa.

Topografie

Le indicazioni concernenti le topografie di prodotti a semiconduttori depositati presso l'Istituto Federale della Proprietà Intellettuale sono menzionate nell'ordine seguente:

- numero di registrazione
- data del deposito
- designazione
- nome e domicilio del/la richiedente
- se del caso, nome e domicilio del/la produttore/trice
- nome e sede di un eventuale mandatario
- data e luogo di un'eventuale prima messa in circolazione della topografia

Hinterlegungen

Dépôts

Deposit

Cl. 14-99 129 012 19.07.2002
 1 Design – Zuschnittkontur und Faltpattern für einen
 Handsteller
 Hinterleger: Designculture AG, Räfelstrasse 11, 8045 Zürich
 Designer: Felix Keller, Zürich
 Vertreter: Felix Keller, Designculture AG, 8045 Zürich
 Ende aufgeschobene Publikation

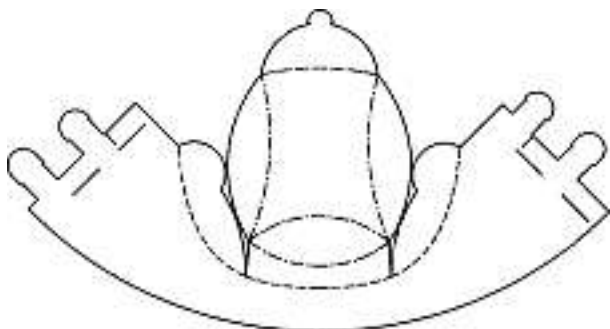

DC-HFS-1

Cl. 02-03 131 267 12.11.2004
 2 design – casque de hockey
 Déposant: SPORT MASKA INC., 3500 de Maisonneuve Blvd.
 West, Suite 800, Westmount, Quebec H3Z 3C1, CA
 Designer: Vittorio Bologna, Westmount; Stephen Murphy,
 Montréal; Alexander Garnet, Beaconsfield
 Mandataire: Micheli & Cie, 1226 Thônex (Genève)
 Priorité: CA, 16.07.2004

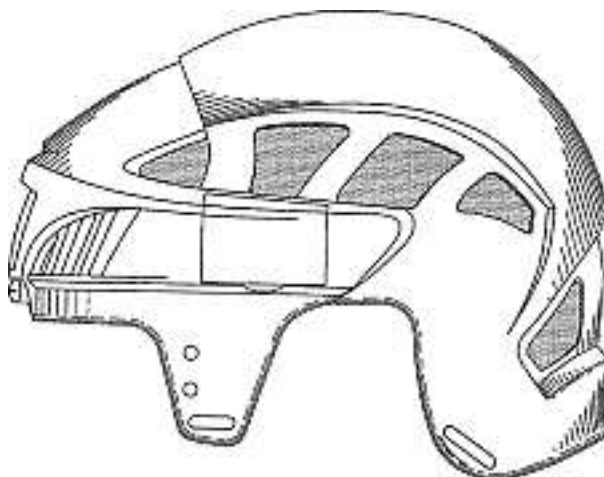
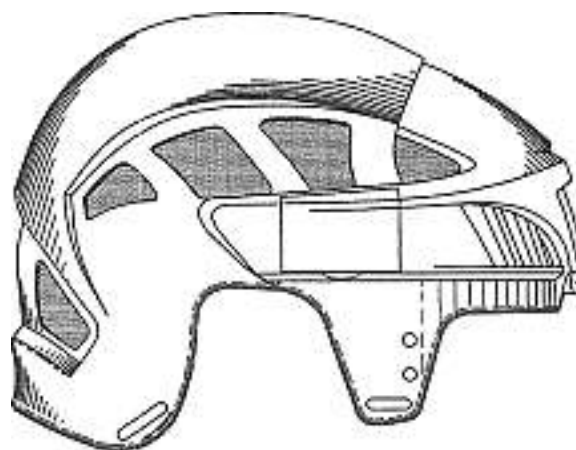
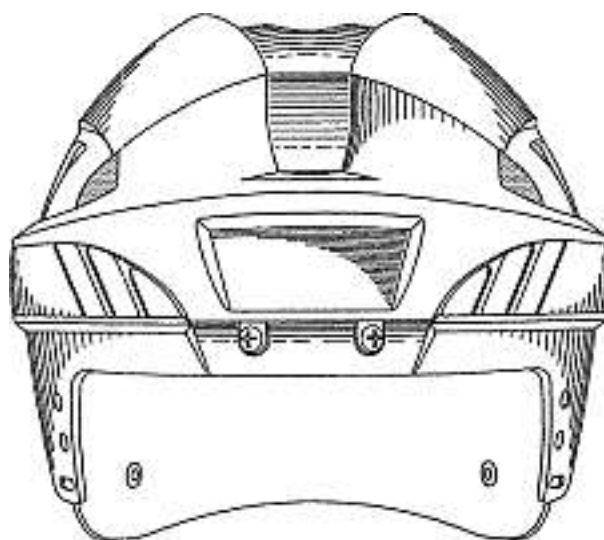

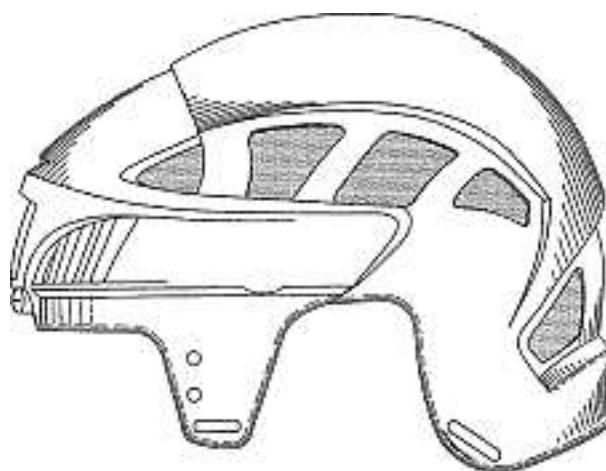
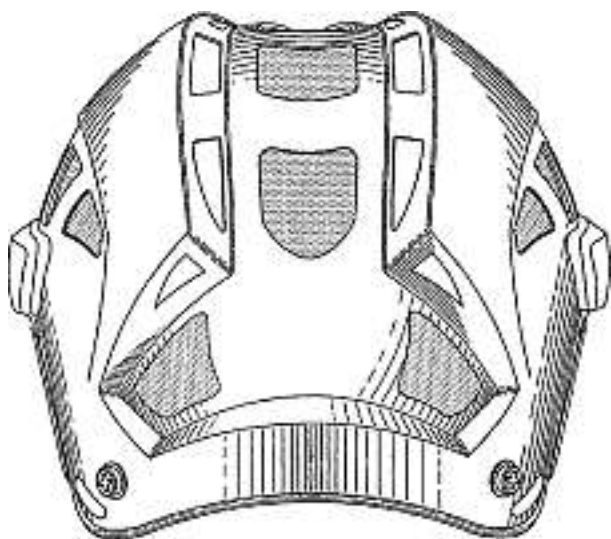
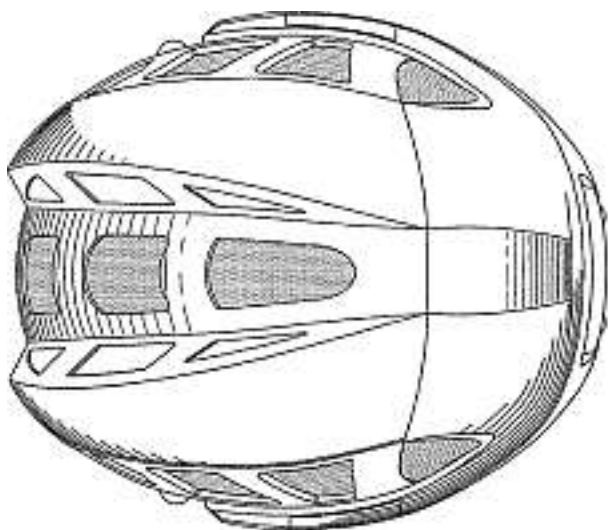

14348A

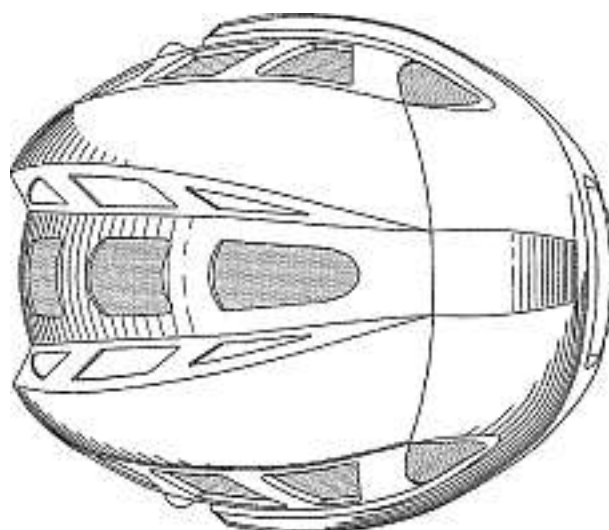

14348B

Cl. 02-07 131 268 08.11.2004
1 Design – Reißverschluss
Hinterleger: PM + MP World Wide GmbH,
c/o Armando Hübscher, Bankstrasse 14, 5432 Neuenhof
Designer: Sacharinka Hübscher, Neuenhof



1

Cl. 03-01 131 269 19.10.2004
63 Design – Taschen
Hinterleger: Rossi Design Ltd., Alfred Escher-Strasse 17,
8002 Zürich
Designer: Francesco Rossi, Zürich
Vertreter: Fuhrer Marbach & Partner, 3007 Bern



1



2



3



4



5



8



6



9



7



10

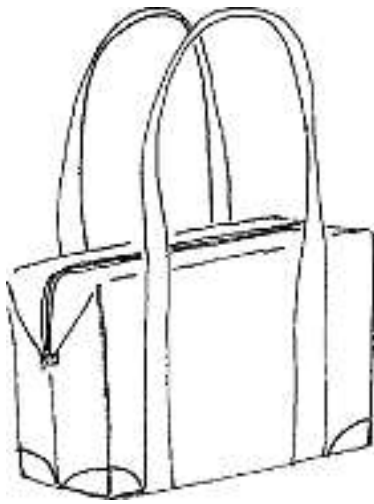

11



14

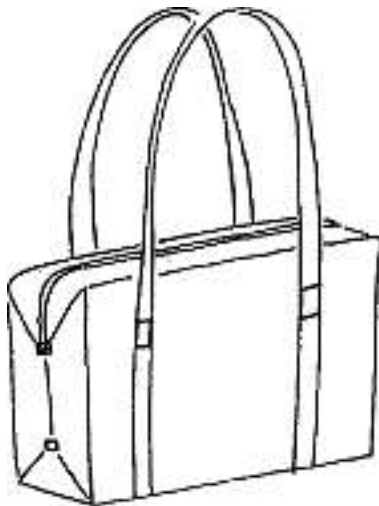

12



15



13

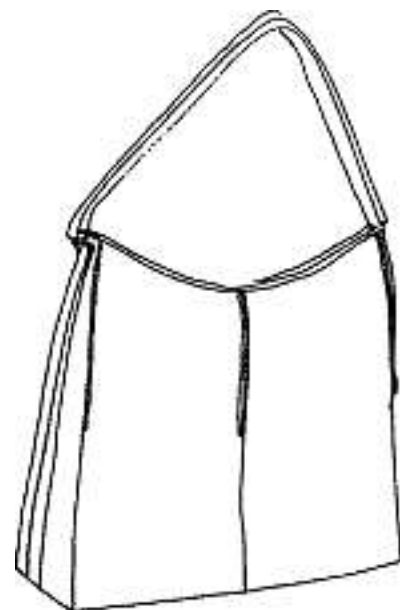

16



17



20



18



21



19



22



23

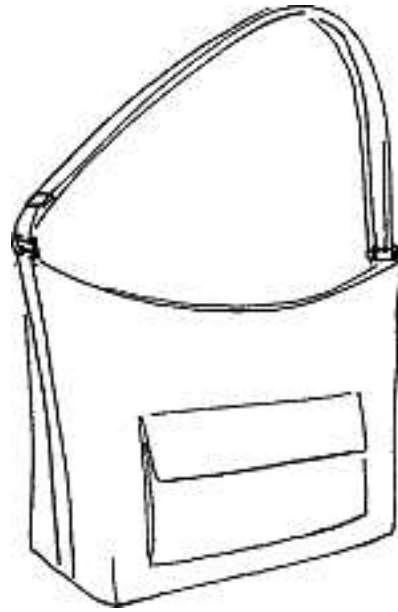

26



24



27



25



28

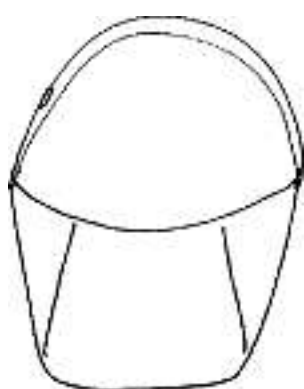

29

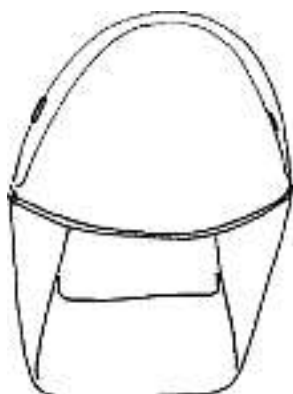

30



31



32



33



34



35

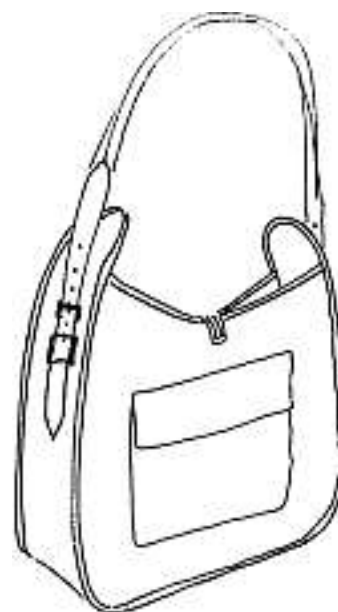

36



37



38



39



42

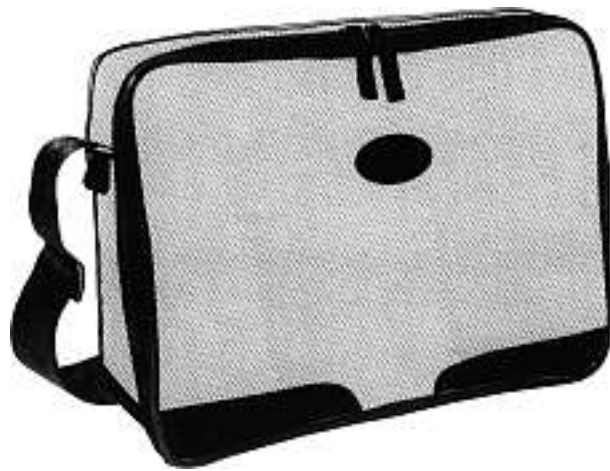

40



43



41

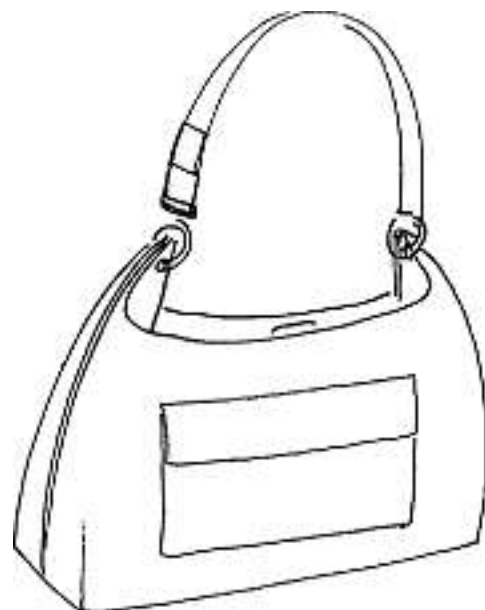

44

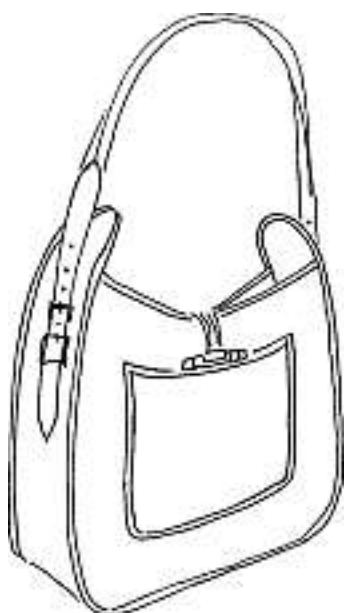

45

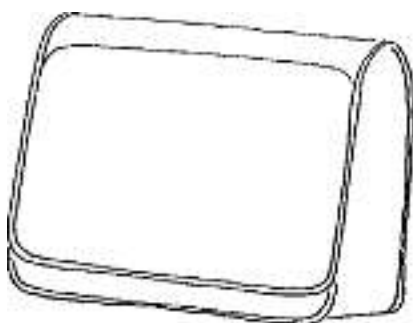

46

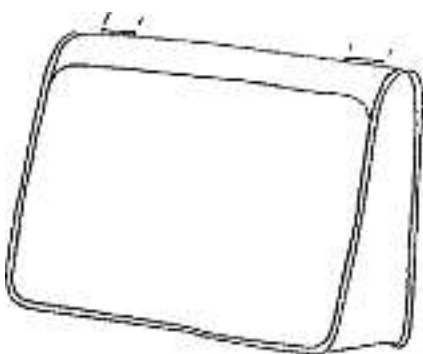

47

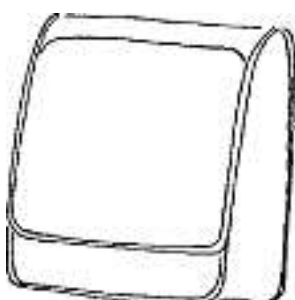

48



49



50

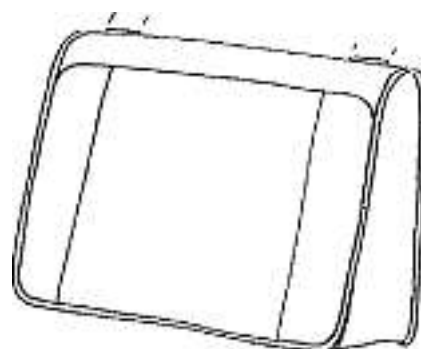

51



52

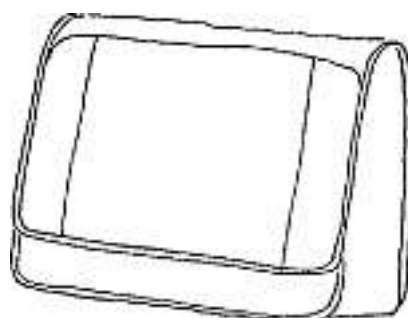

53



54



55



56

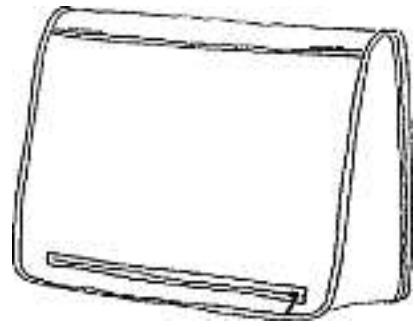

57



58

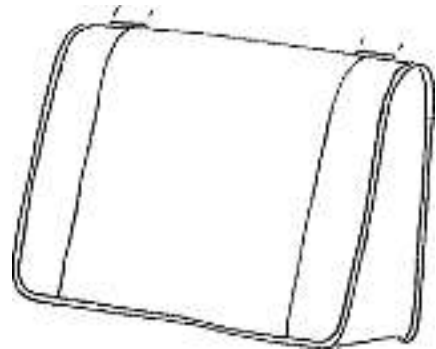

59

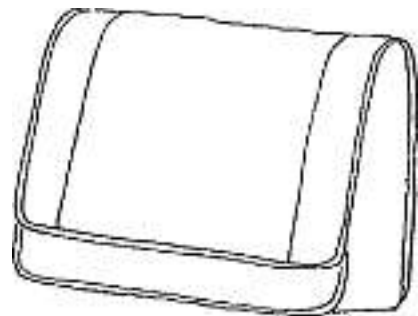

60

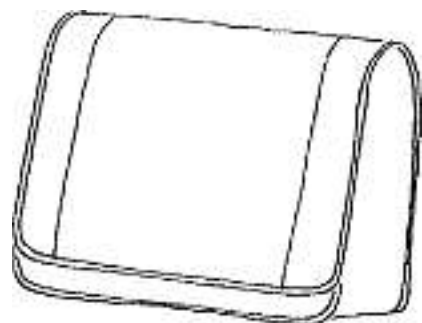

61

62

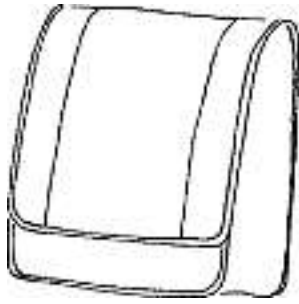

63



Cl. 06-03 **131 270** 08.11.2004
 2 Design – Tische
 Hinterleger: Heinz Baumann, Möbelmanufaktur,
 Bahnhofstrasse 15a, 9450 Altstätten SG
 Designer: Heinz Baumann, Altstätten



Nove



Esprit

Cl. 06-03 **131 271** 07.12.2004
 2 Design – Aufsatzbrett mit Handlauf für Ladentisch
 Hinterleger: Showa Kasei Company, Ltd., 3-4 Kyomachibori
 2-chome, Nishi-ku, Osaka-shi, Osaka, JP; Yoshikazu Shibata,
 80-3, Higashisonodacho 3-chome, Amagasaki-shi, Hyogo, JP
 Designer: Yoshikazu Shibata, Hyogo
 Vertreter: Schmauder & Partner AG, Patentanwaltsbüro,
 8038 Zürich
 Priorität: JP, 01.07.2004; JP, 01.07.2004

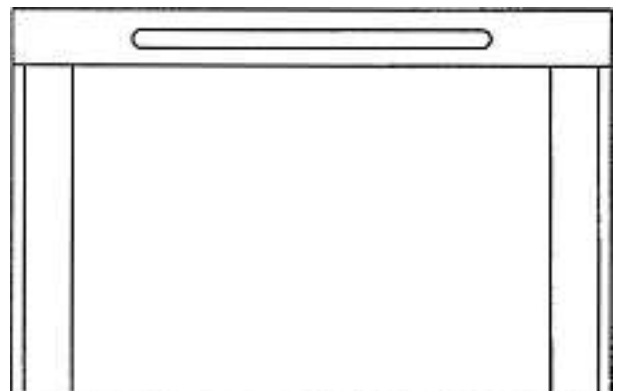

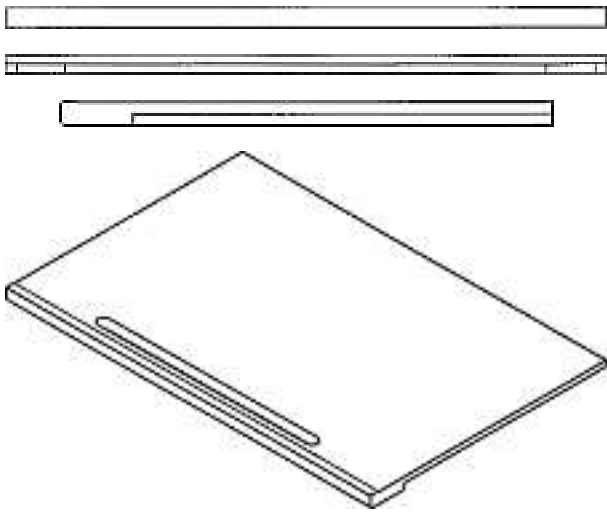

21

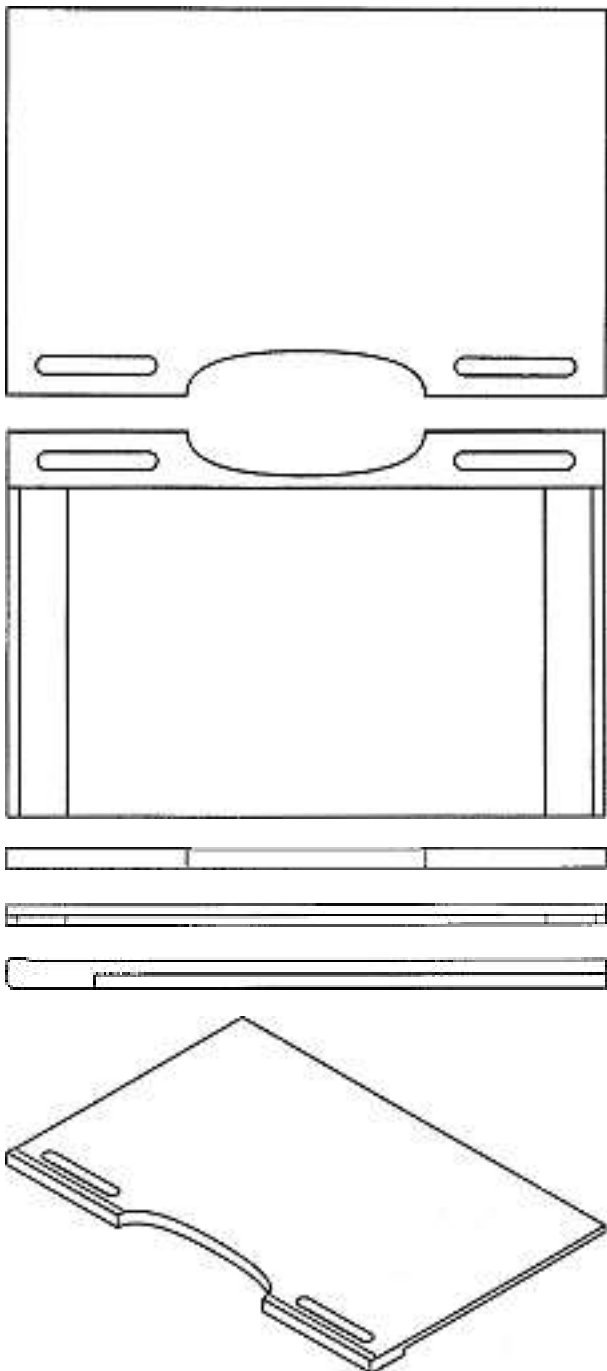

22

Cl. 06-06 131 272 02.12.2004
1 Design – Möbeleckverbinder
Hinterleger: Marc Müller, Rötelstrasse 3, 8006 Zürich

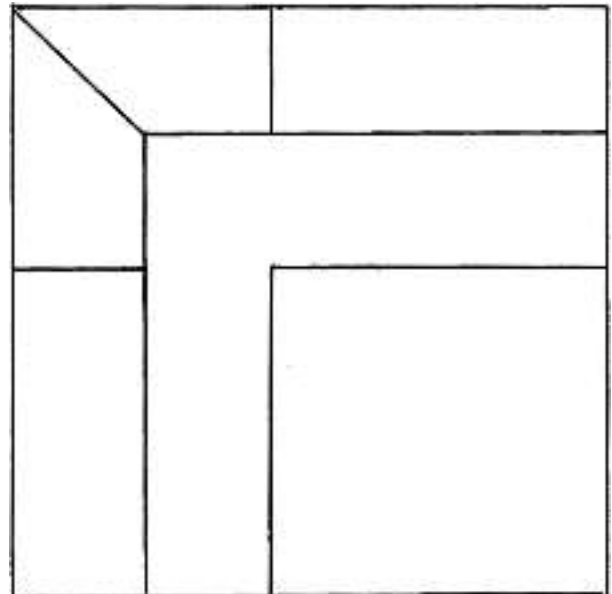
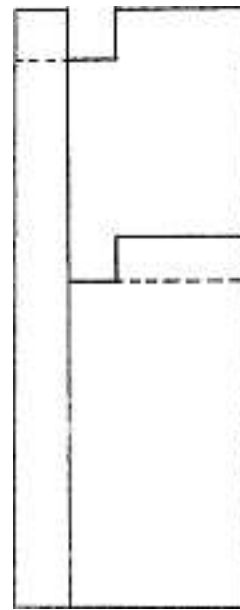

Stecki

Cl. 07-01, 07-02, 07-03 131 273 09.11.2004
26 Design – Rechaud, Bestecke, Fonduegabelgriffe,
Fonduegabelzinken, Salatbesteck, Käsebrett
Hinterleger: Schwarz Frères S.A. , 7, rue des Sablières,
1214 Vernier
Designer: François Martinoli, Collex
Vertreter: Patentanwälte Feldmann & Partner AG,
8152 Glattbrugg



1



2



3



4



5



6



7



8



9



10



11



12



13



14



15



16



17



18



19



20



21



22



23



24



25



26

Cl. 07-01 131 274 14.12.2004
 1 Design – Deckel
 Hinterleger: Dart Industries Inc., 14901 S. Orange Blossom Trail, Orlando / FL, US
 Designer: Hanno Kortleven, Rotselaar
 Vertreter: A. Braun, Braun, Héritier, Eschmann AG, Patentanwälte, 4051 Basel
 Priorität: US, 25.06.2004

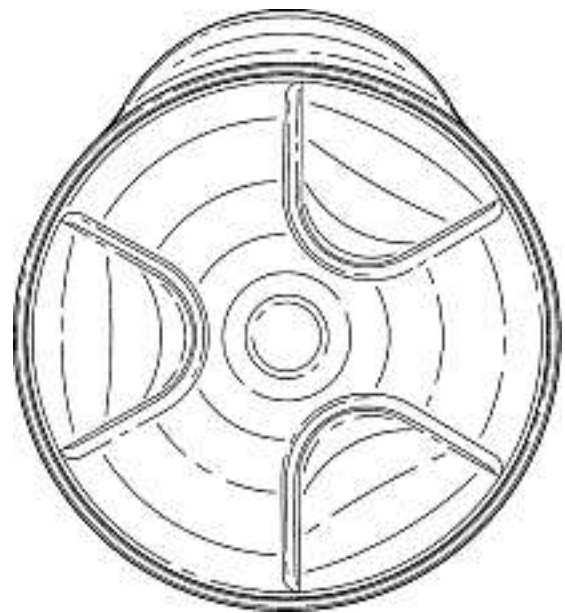
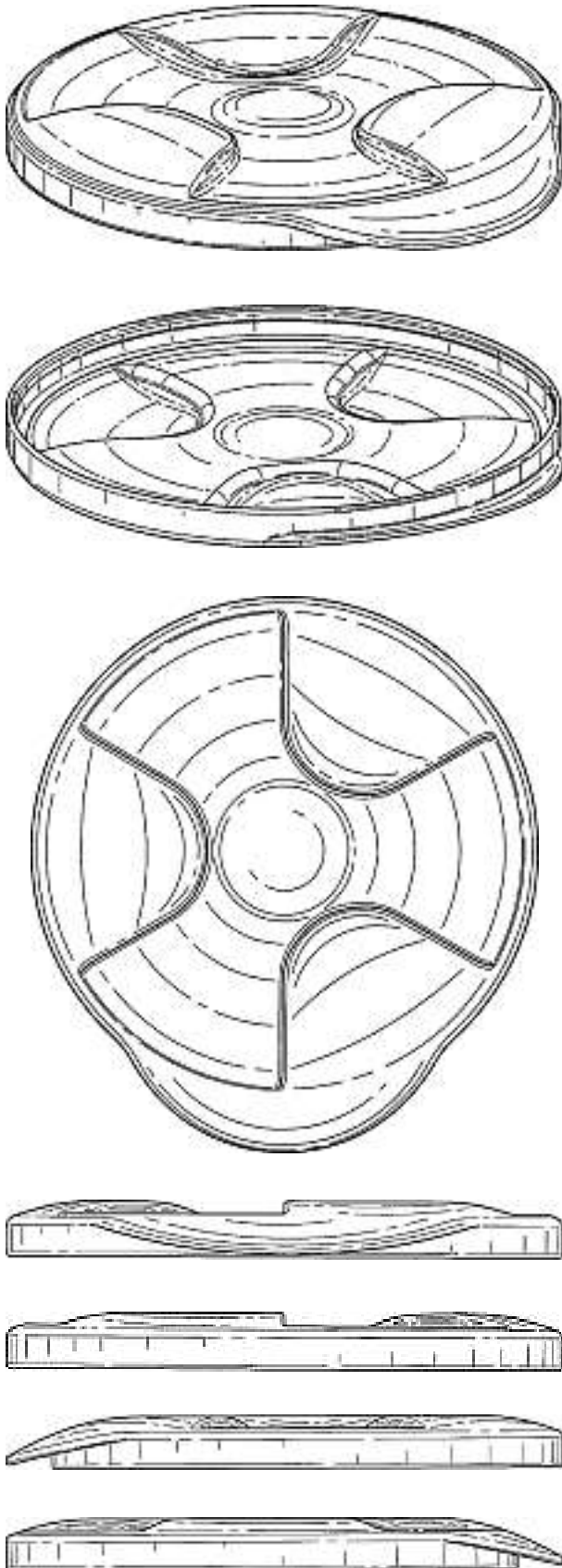

D. 100/2004

Cl. 07-04 131 276 23.11.2004
 1 Design – Teigwarensieb
 Hinterleger: Kuhn Rikon AG, 8486 Rikon im Tösstal
 Designer: Rolf Zeindler, Winterthur
 Vertreter: Isler & Pedrazzini AG, 8023 Zürich

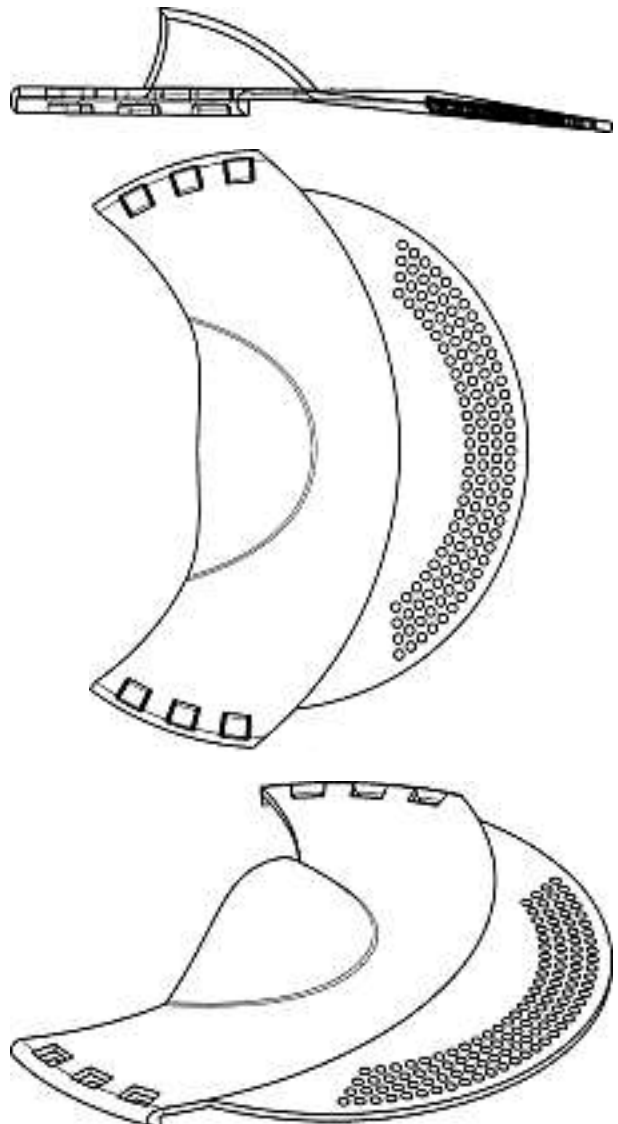

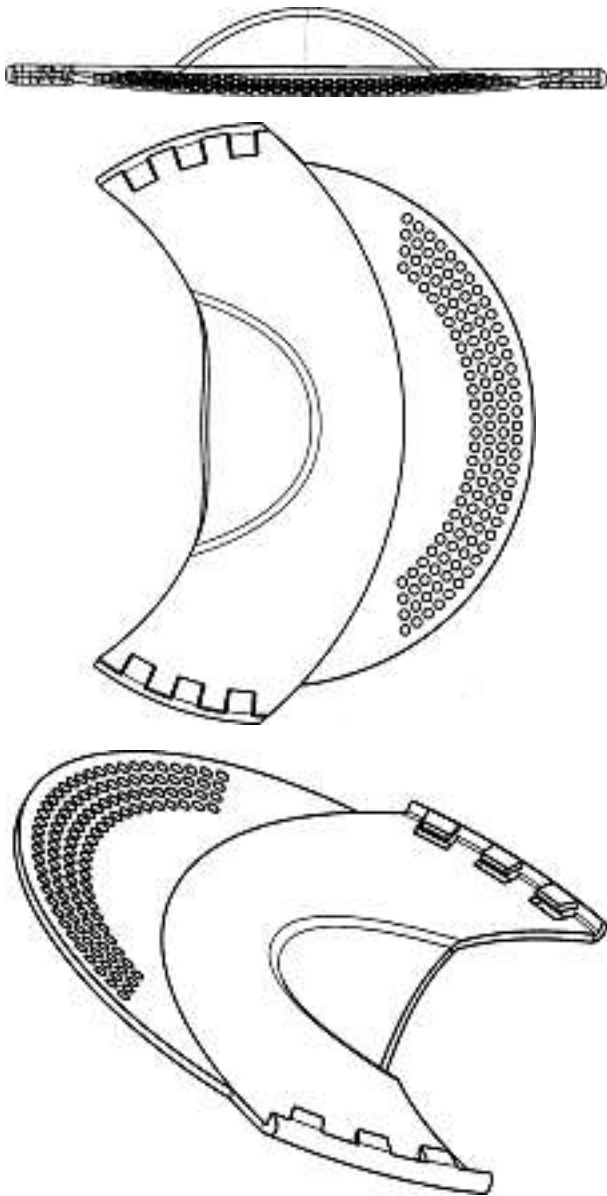

M12960

Cl. 07-04 131 277 14.12.2004
1 Design – Saftpresse
Hinterleger: Dart Industries Inc., 14901 S. Orange Blossom Trail, Orlando / FL, US
Designer: Jan-Hendrik de Groot, Brüssel
Vertreter: A. Braun, Braun, Héritier, Eschmann AG, Patentanwälte, 4051 Basel
Priorität: US, 25.06.2004

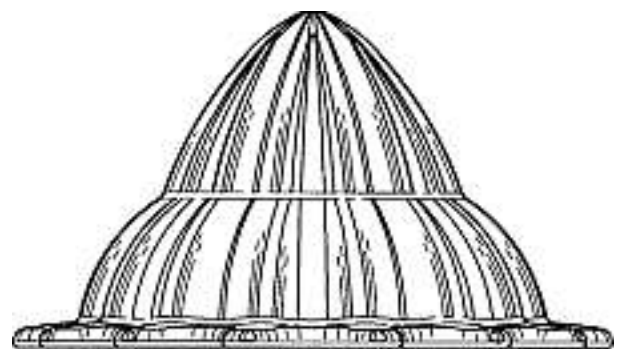
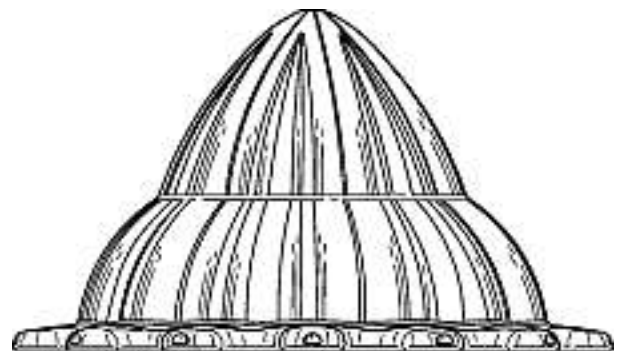
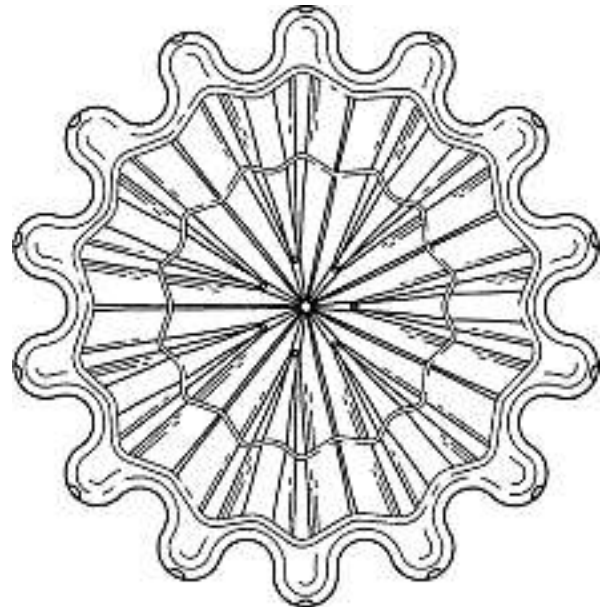
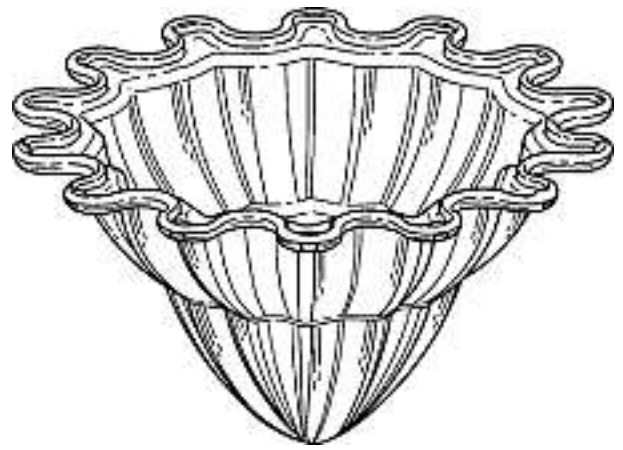
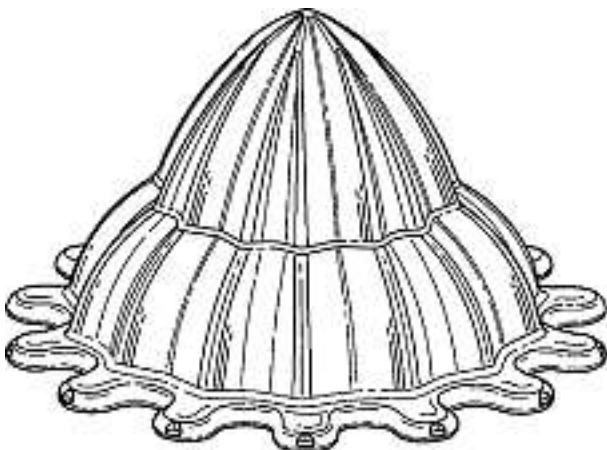

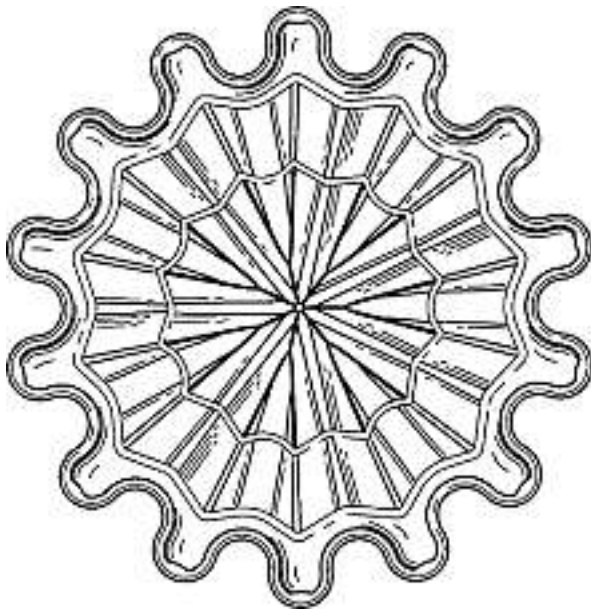
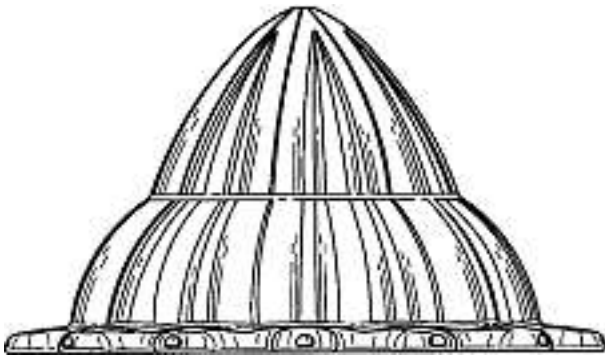
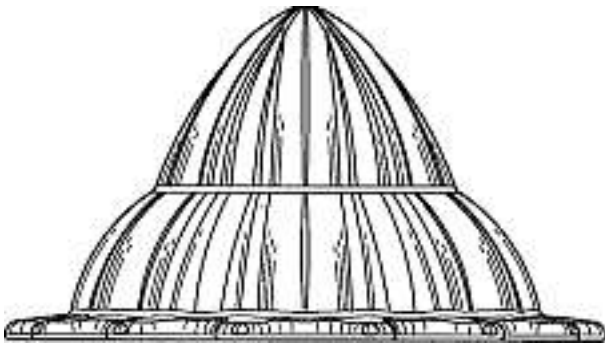

D. 101/2004

Cl. 07-04 131 278 14.12.2004
 1 Design – Reibe/Sieb
 Hinterleger: Dart Industries Inc., 14901 S. Orange Blossom Trail, Orlando / FL, US
 Designer: Jan-Hendrik de Grootte, Brüssel
 Vertreter: A. Braun, Braun, Héritier, Eschmann AG, Patentanwälte, 4051 Basel
 Priorität: US, 25.06.2004

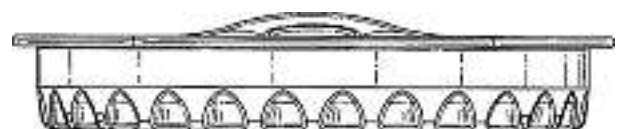
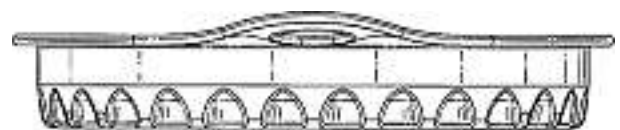
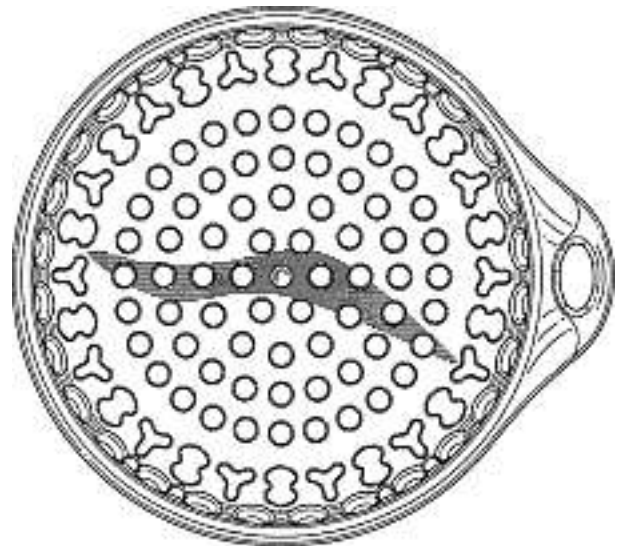
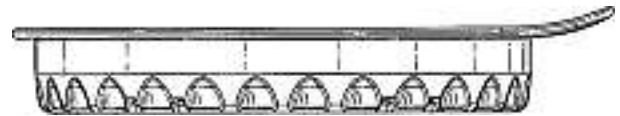
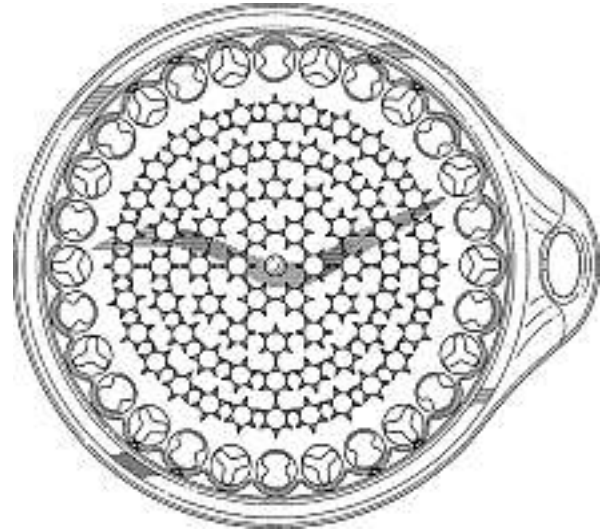
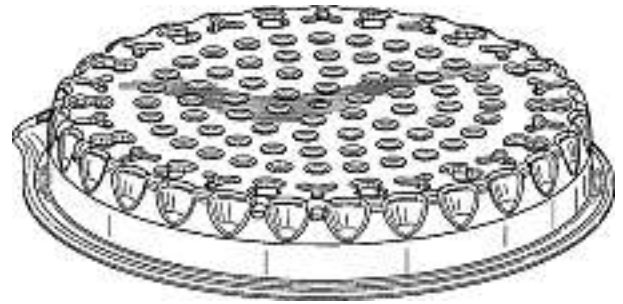
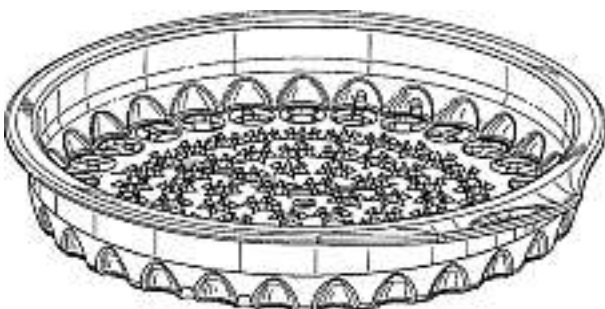

D. 102/2004

Cl. 08-06 **131 279** 08.10.2004
 32 Design – Türknauf
 Hinterleger: Kaba AG, Mühlebühlstrasse 23, 8620 Wetzikon
 Designer: Werner Kühnlein, Meilen
 Vertreter: Frei Patentanwaltsbüro, 8029 Zürich
 1 (siehe Farbteil Heftmitte)
 2 (siehe Farbteil Heftmitte)
 3 (siehe Farbteil Heftmitte)
 4 (siehe Farbteil Heftmitte)
 5 (siehe Farbteil Heftmitte)
 6 (siehe Farbteil Heftmitte)
 7 (siehe Farbteil Heftmitte)
 8 (siehe Farbteil Heftmitte)
 9 (siehe Farbteil Heftmitte)
 10 (siehe Farbteil Heftmitte)
 11 (siehe Farbteil Heftmitte)
 12 (siehe Farbteil Heftmitte)
 13 (siehe Farbteil Heftmitte)
 14 (siehe Farbteil Heftmitte)
 15 (siehe Farbteil Heftmitte)
 16 (siehe Farbteil Heftmitte)
 17 (siehe Farbteil Heftmitte)
 18 (siehe Farbteil Heftmitte)
 19 (siehe Farbteil Heftmitte)
 20 (siehe Farbteil Heftmitte)
 21 (siehe Farbteil Heftmitte)
 22 (siehe Farbteil Heftmitte)
 23 (siehe Farbteil Heftmitte)
 24 (siehe Farbteil Heftmitte)
 25 (siehe Farbteil Heftmitte)
 26 (siehe Farbteil Heftmitte)
 27 (siehe Farbteil Heftmitte)
 28 (siehe Farbteil Heftmitte)
 29 (siehe Farbteil Heftmitte)
 30 (siehe Farbteil Heftmitte)
 31 (siehe Farbteil Heftmitte)
 32 (siehe Farbteil Heftmitte)



M12927/1



M12927/2



M12927/3



M12927/4

Cl. 08-08 **131 280** 11.11.2004
 1 Design – Halteklammer
 Hinterleger: Stefan Schneller, Segantinstrasse 213,
 8049 Zürich



CLAMY

Cl. 09-01 **131 281** 29.09.2004
 4 Design – Flasche und Flaschenbemusterung
 Hinterleger: R & A Bailey & Co, Nangor House, Western
 Estate, Dublin 12, IE
 Designer: Richard Brandt, New York; Peter Knapp, London;
 Chris Hart, London; Matthew Scott, New York; Joanne
 Emery, London
 Vertreter: Isler & Pedrazzini AG, 8023 Zürich
 Priorität: EM, 16.04.2004; EM, 09.06.2004
 M12925/1 (siehe Farbteil Heftmitte)
 M12925/2 (siehe Farbteil Heftmitte)
 M12925/3 (siehe Farbteil Heftmitte)
 M12925/4 (siehe Farbteil Heftmitte)

Cl. 09-01 **131 282** 29.09.2004
 6 Design – Flasche und Flaschenbemusterung
 Hinterleger: R & A Bailey & Co, Nangor House, Western
 Estate, Dublin 12, IE
 Designer: Richard Brandt, New York; Peter Knapp, London;
 Chris Hart, London; Matthew Scott, New York; Joanne
 Emery, London
 Vertreter: Isler & Pedrazzini AG, 8023 Zürich
 Priorität: EM, 16.04.2004; EM, 09.06.2004



M12927/5

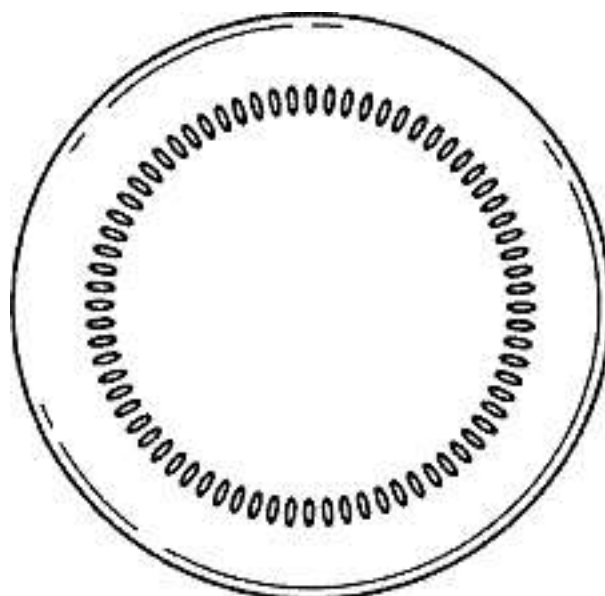
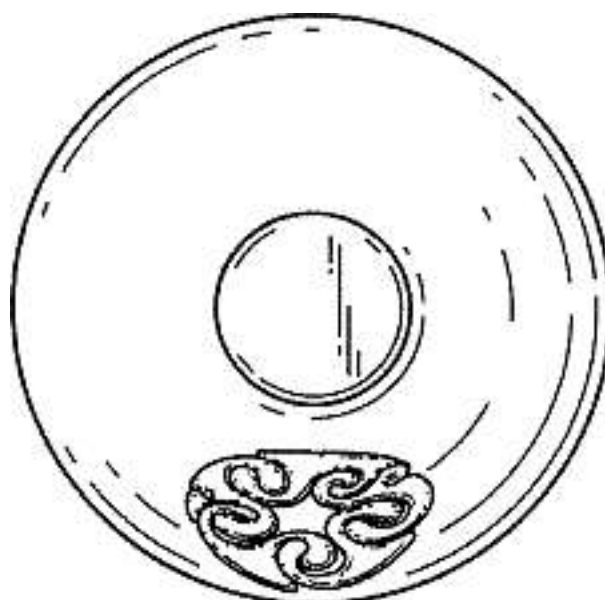
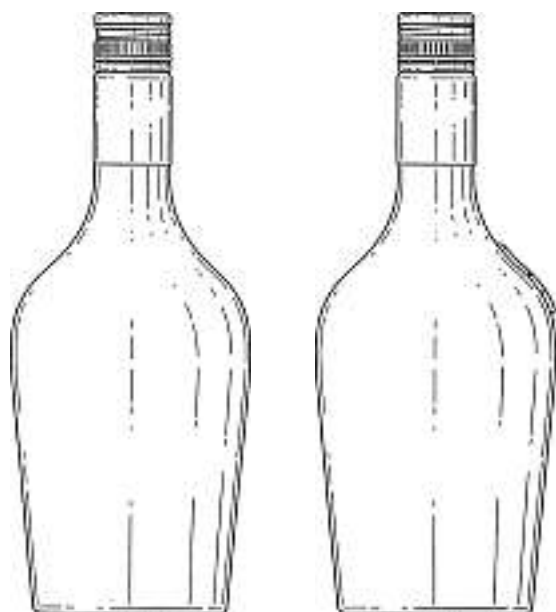

M12927/6

Cl. 09-03 131 283 10.12.2004

1 design – boîte d'emballage

Déposant: Guy Vanhoutte, Hazenveld 7, Oudenaken, BE

Mandataire: Katzarov S.A., 1227 Genève

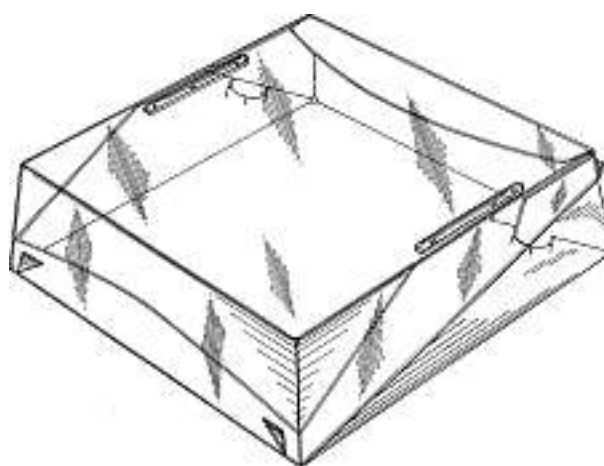

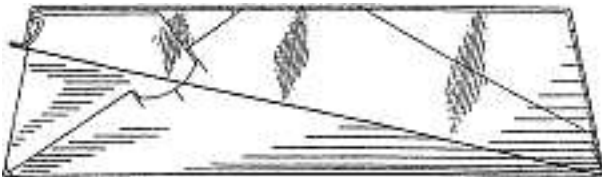
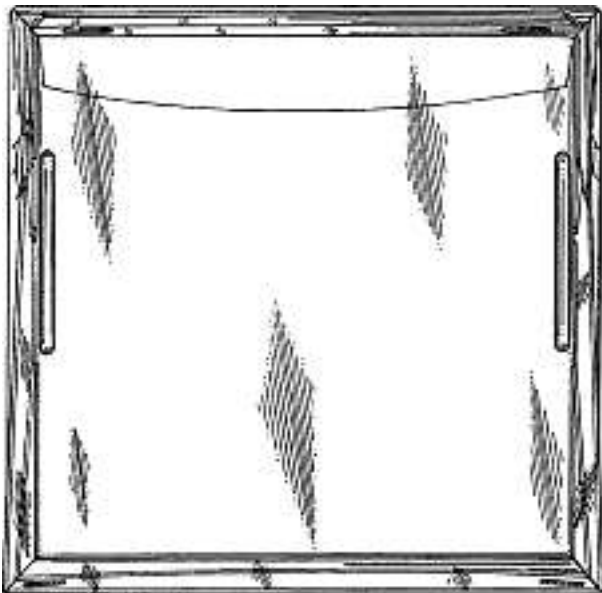

14874 / CH

Cl. 10-07 131 284 22.10.2004

1 design - quadrante
 Depositante: Glen Rossi, 6803 Camignolo
 Mandatario: Studio legale e notarile, Avv. Walter Zandrini,
 6901 Lugano

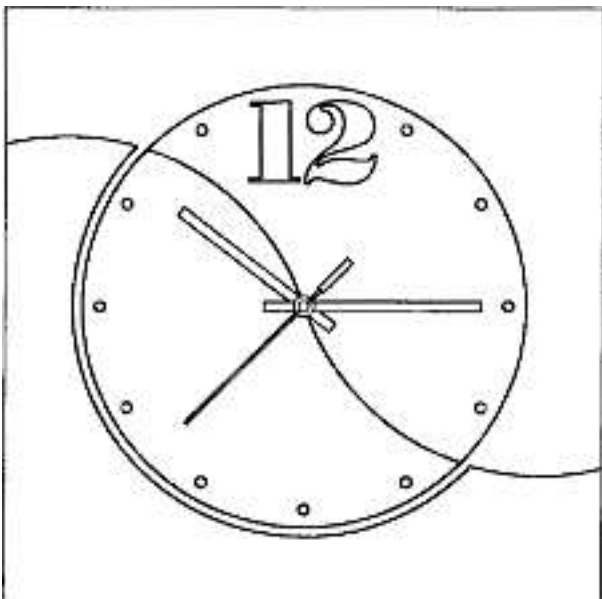

G-Collection

Cl. 11-01 131 287 11.11.2004
 53 Design - Trauringe
 Hinterleger: Meister + Co AG, Hauptstrasse 66, 8832 Wollerau
 Designer: Silvio Daldini, Kilchberg ZH; Thomas Geiser,
 Wollerau; Dieter Flehmer, Unteriberg; Marcus Siessegger,
 Wollerau



1.1



1.2

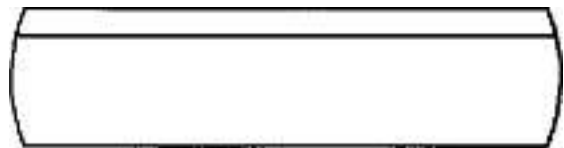

2.1

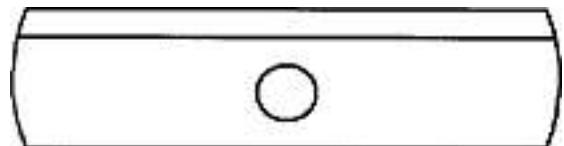

2.2

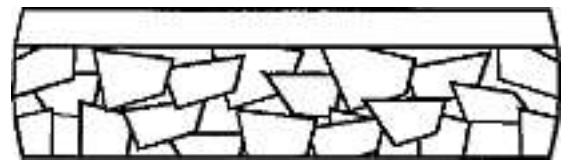

3.1



3.2

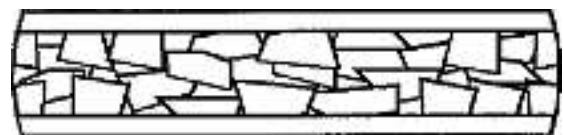

4.1



4.2

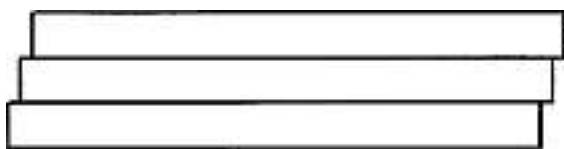

5.1

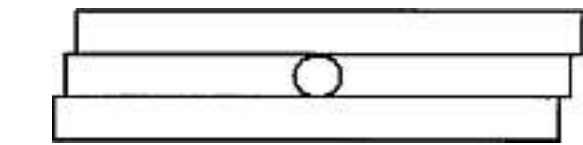

5.2



6.1

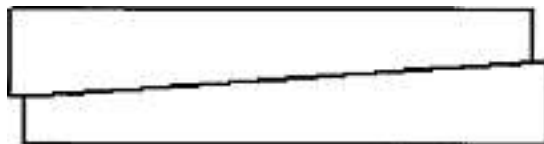

7.1

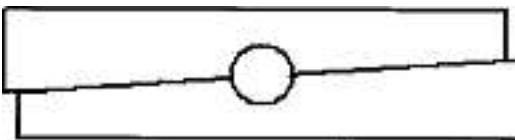

7.2

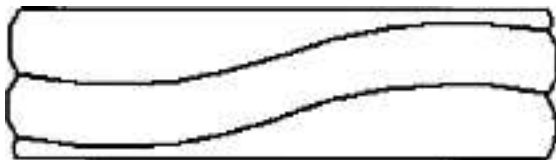

8.1

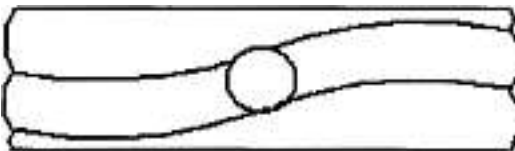

8.2



9.1

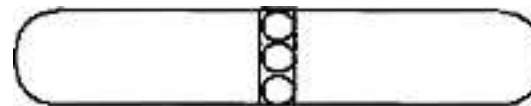

9.2



10.1

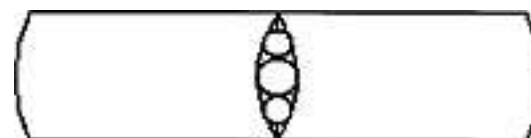

10.2



11.1

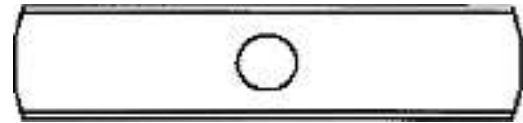

11.2



12.1

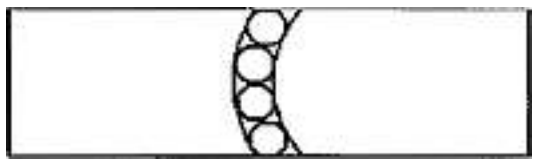

12.2

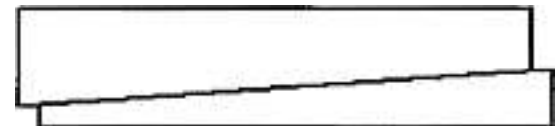

13.1

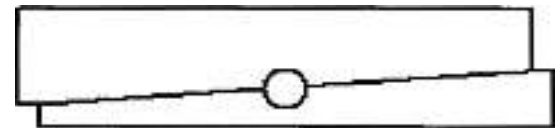

13.2

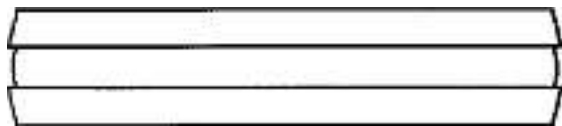

14.1

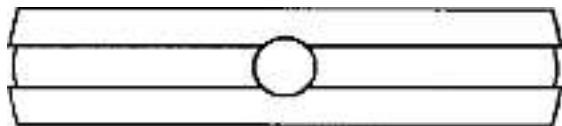

14.2



15.1

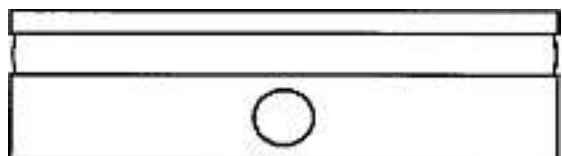

15.2



16.1

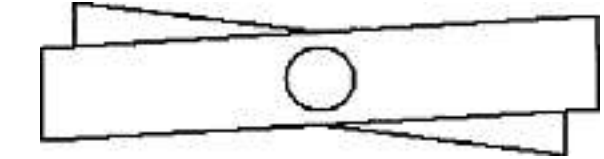

16.2



17.1

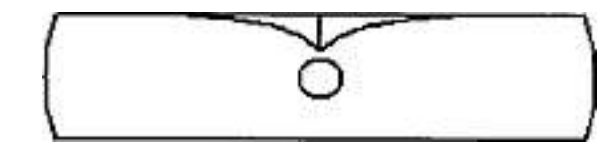

17.2



18.1

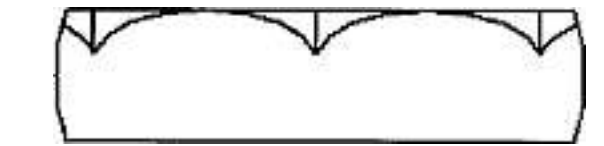

18.2

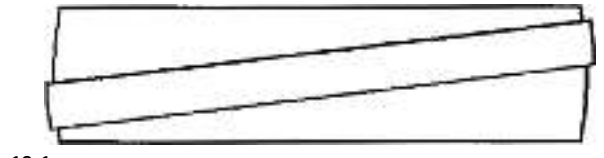

19.1

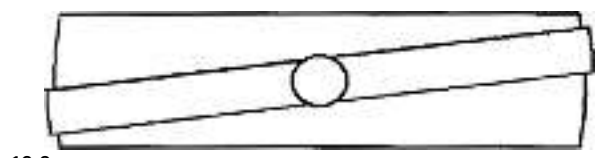

19.2

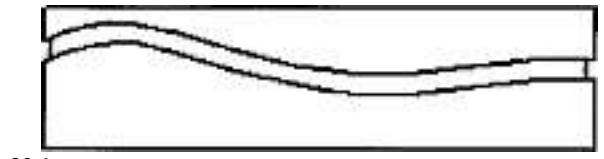

20.1

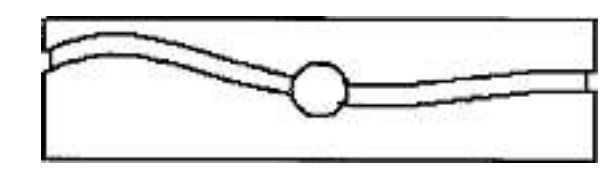

20.2

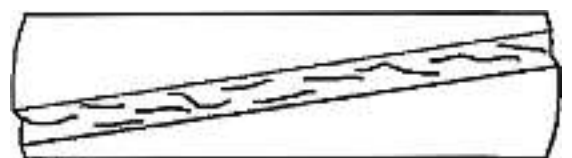

21.1

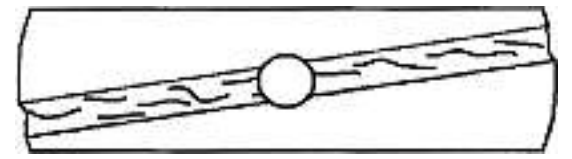

21.2

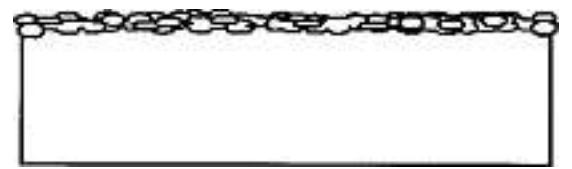

22.1

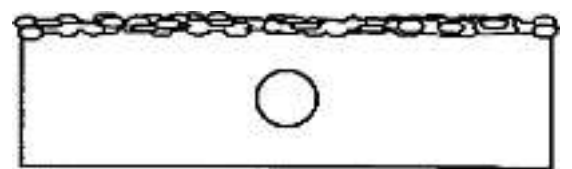

22.2

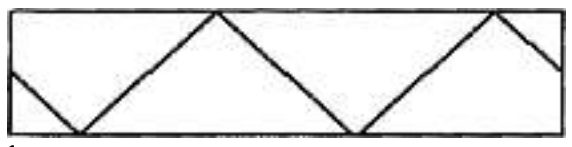

23.1

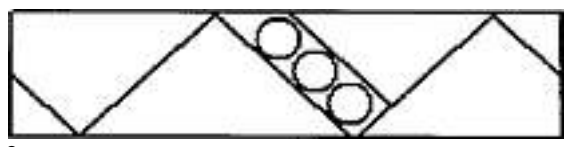

23.2

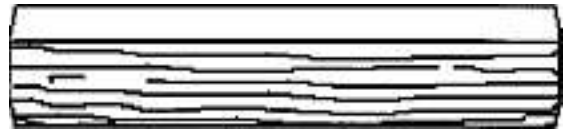

24.1

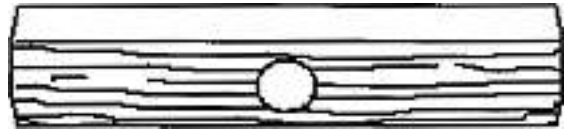

24.2



25.1

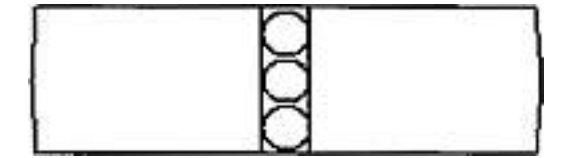

25.2

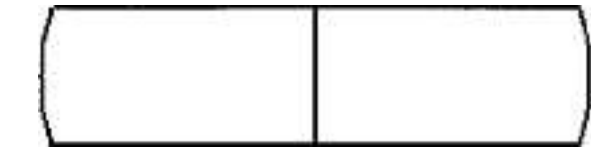

26.1

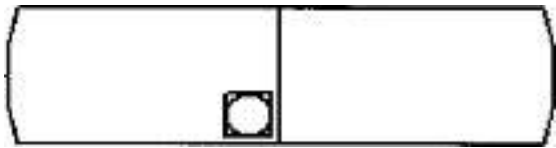

26.2

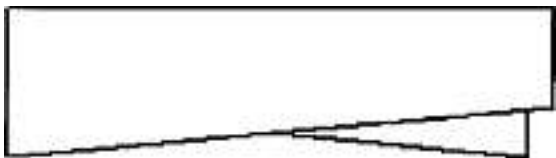

27.1

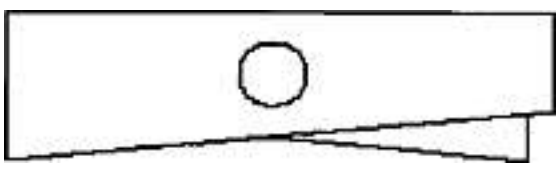

27.2

Cl. 11-01 131 288 12.11.2004
 2 Design – Schmuckstücke
 Hinterleger: Gertrud Ries, Rütthardstrasse 3, 4127 Birsfelden

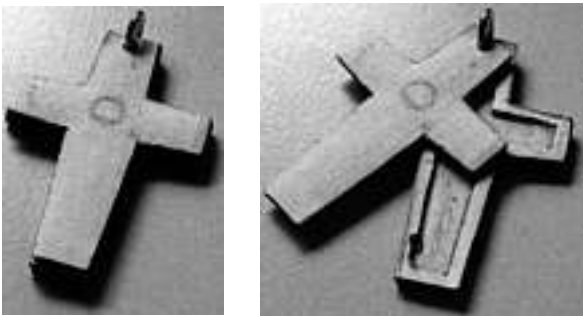

Kreuz



Taube

Cl. 11-01 131 289 15.11.2004
 1 Design – Edelstein
 Hinterleger: Doron Golan, 23 Kamil Hoismans Street, Netanya, IL; Gil Melamed, 8 Ha'Irusim Street, Ramat Poleg, Netanya, IL
 Vertreter: Isler & Pedrazzini AG, 8023 Zürich
 Priorität: IL, 24.05.2004

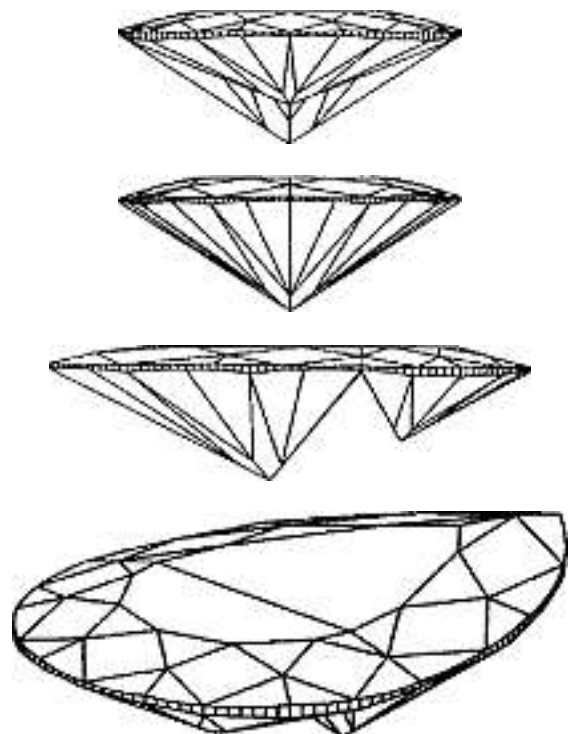

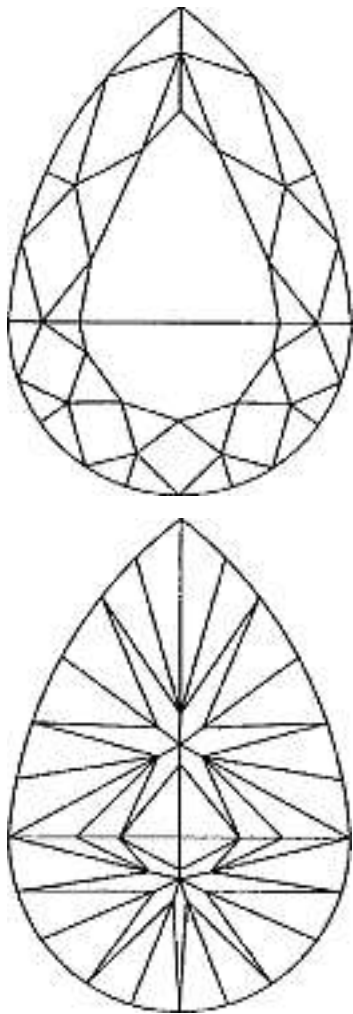

M12954

Cl. 11-01 **131 290** 23.12.2004
 1 Design – Armband
 Hinterleger: Theodor Meier, Lächlerstrasse 39,
 8634 Hombrechtikon
 1 (siehe Farbteil Heftmitte)

Cl. 13-03 **131 292** 30.11.2004
 2 Design – Elektrischer Stecker
 Hinterleger: RIT Technologies Ltd.,
 Raoul Wallenberg Street 24, 69719 Tel Aviv, IL
 Designer: Pinhas Shifris, Tel-Aviv
 Vertreter: Dr. Graf & Partner, 8201 Schaffhausen
 Priorität: US, 02.06.2004

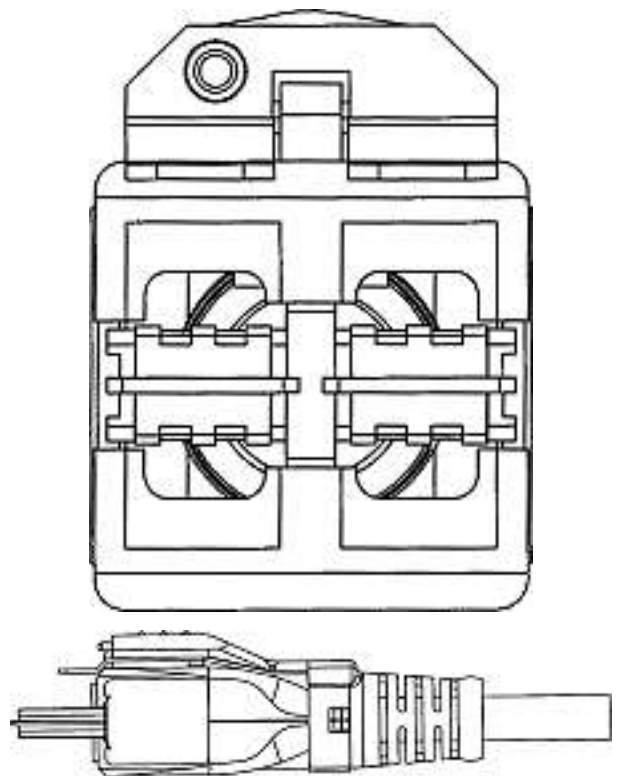
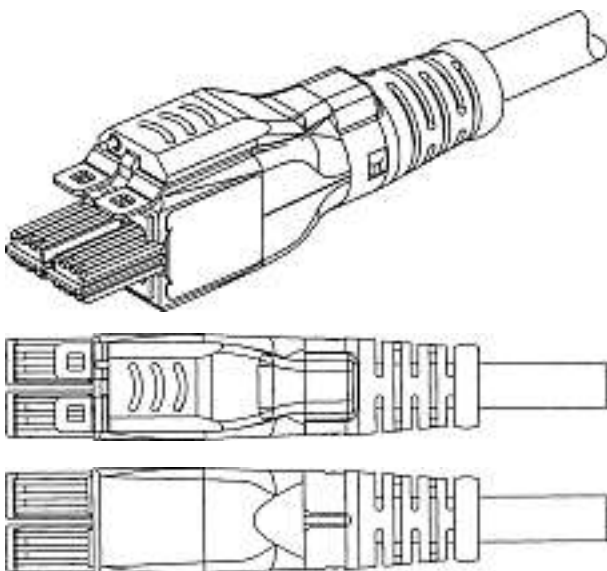
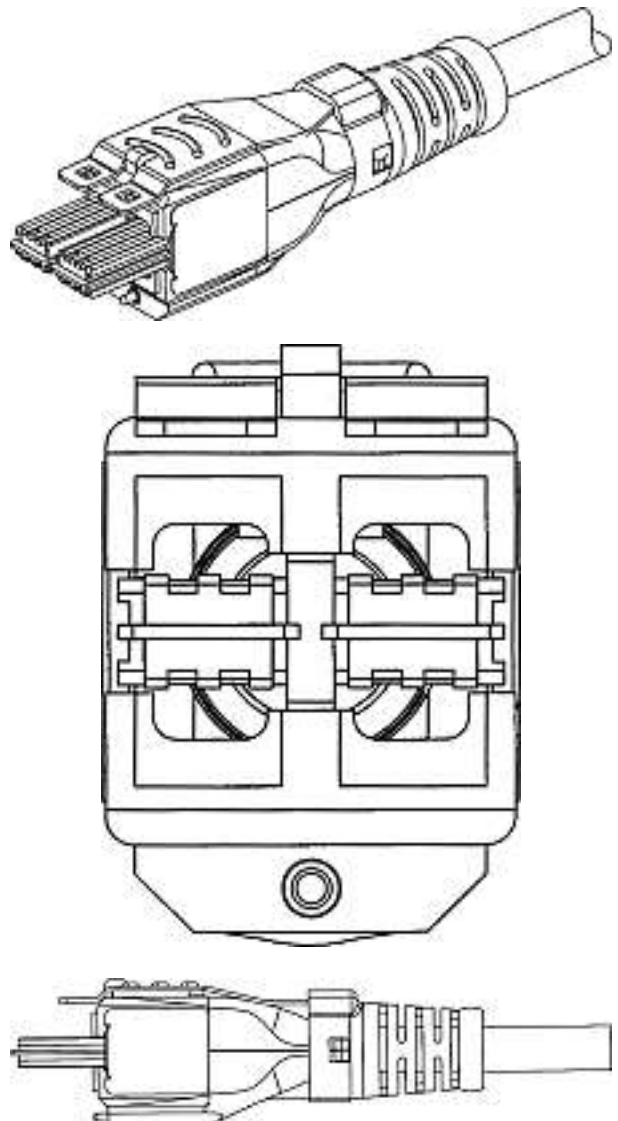

Fig 1



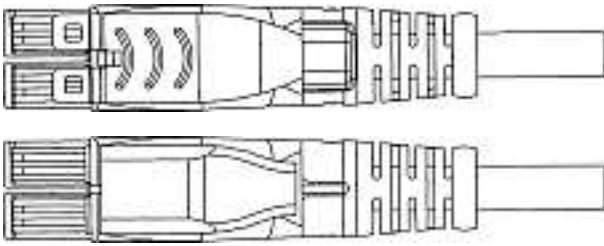
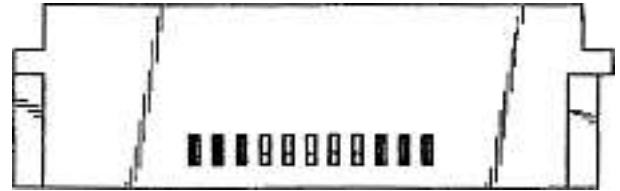
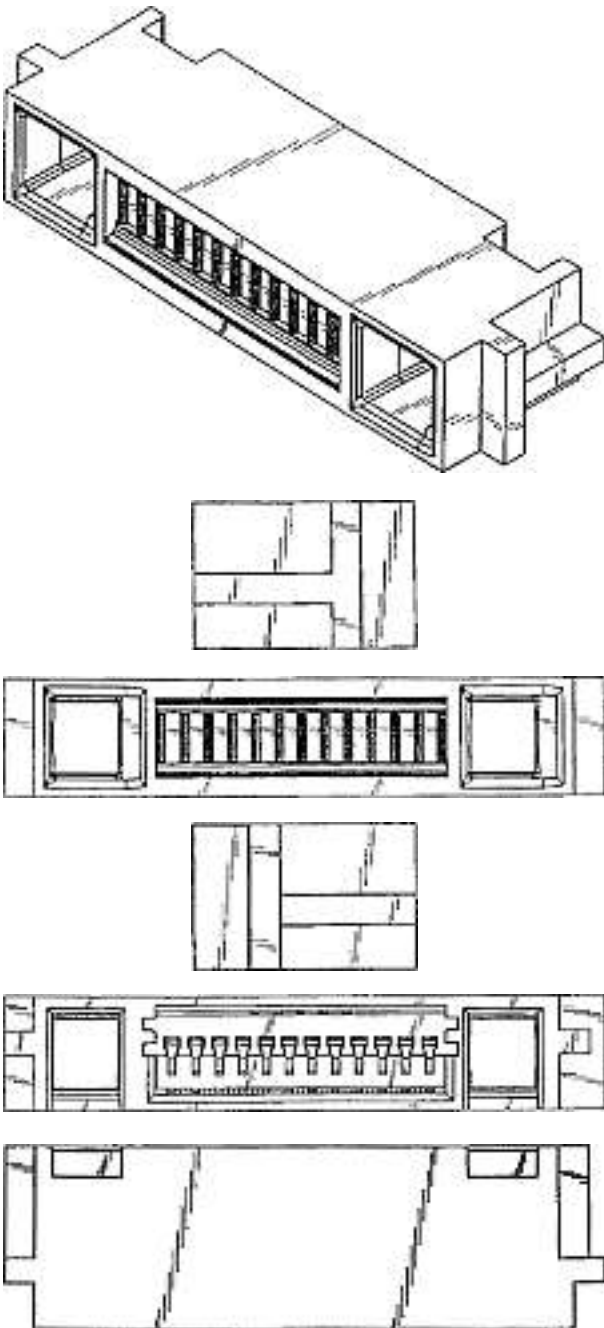
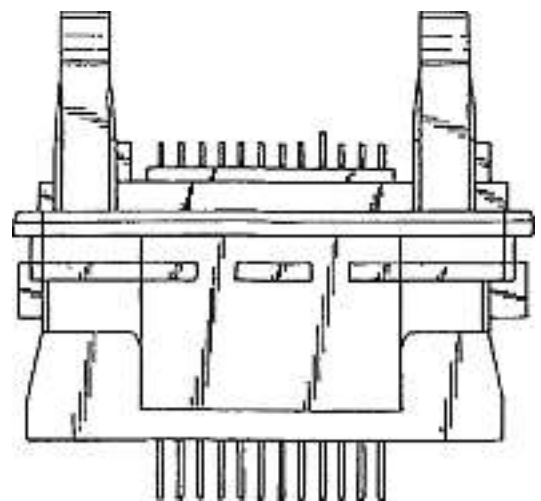
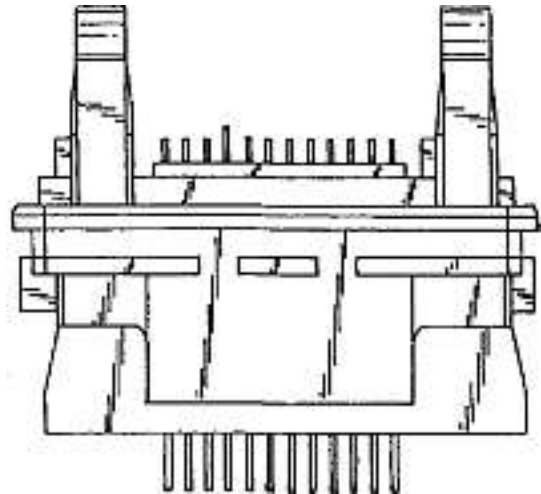
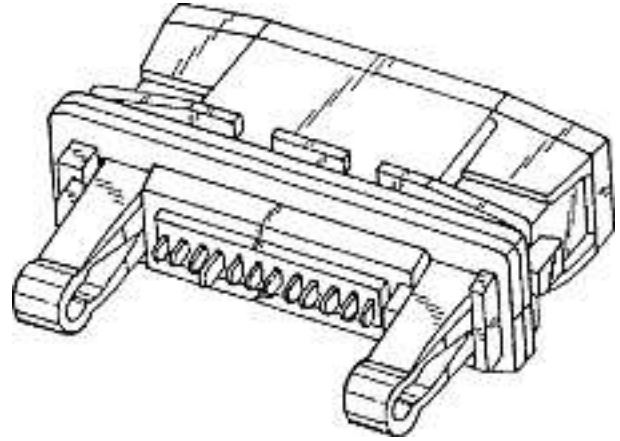

Fig 2

Cl. 14-01, 14-03 **131 293** 19.11.2004
 2 Design – Systemverbinder und Stecker für Mobiltelefone
 und Ohrhörer
 Hinterleger: Sony Ericsson Mobile Communications AB,
 Nya Vattentornet, Lund, SE
 Designer: Johannes De Jonge, Södra Sandby; Peter Jaeger,
 Dussen
 Vertreter: Isler & Pedrazzini AG, 8023 Zürich
 Priorität: EM, 10.06.2004; EM, 11.10.2004



M12955-1



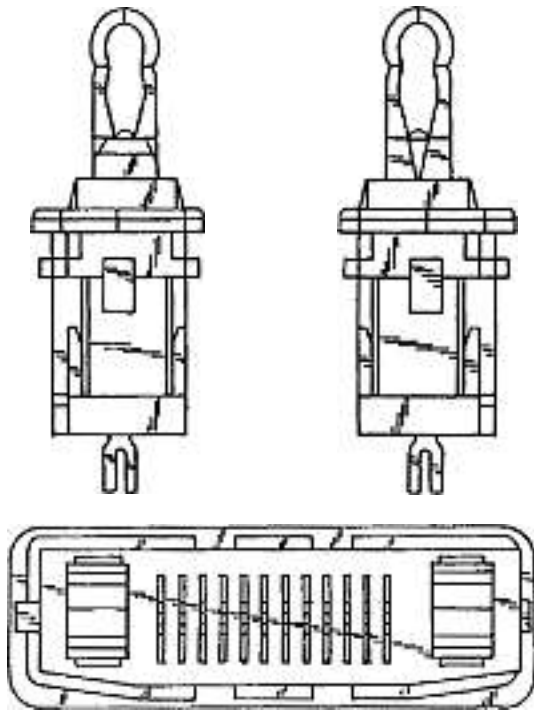

M12955-2

Cl. 14-02 **131 294** 17.12.2004
 1 design – dissipateur pour carte graphique
 Déposant: Zalman Tech Co., Ltd., 1007 Daeryung Techno Town III, 448 Gasan-dong, Gumchun-gu, Seoul 153-803, KR
 Designer: Sang Cheol Lee, Kunpo-city
 Mandataire: Novagraaf International SA, 1220 Les Avanchets
 Priorité: KR, 20.09.2004

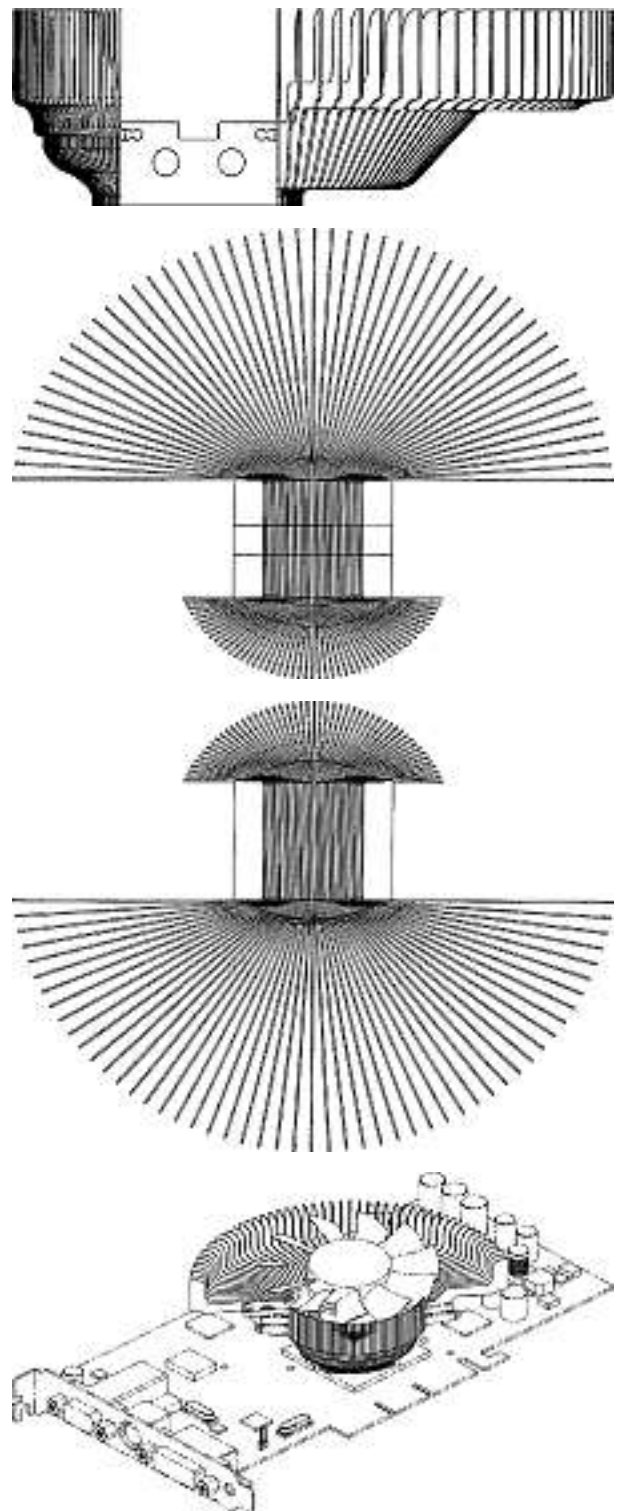
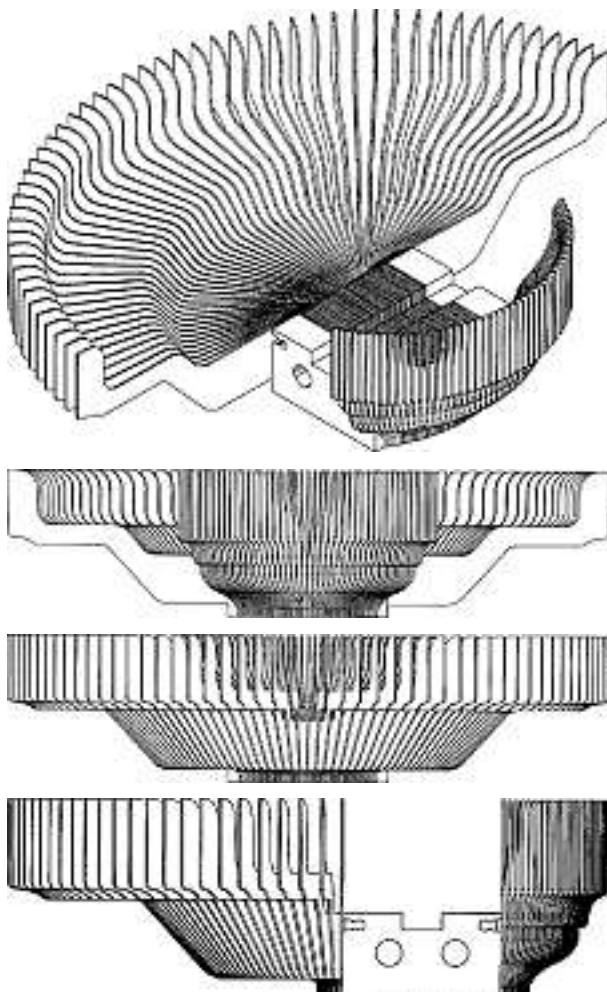

MB 53215

Cl. 14-02 **131 295** 21.12.2004
 1 Design – Farbbandkassette
 Hinterleger: Brother Industries, Ltd, 15-1, Naeshiro-cho, Mizuho-ku, Nagoya-shi / Aichi-ken, JP
 Designer: Hideki Yamamoto, Nagoya-Shi; Yasutake Yamaguchi, Nagoya-Shi
 Vertreter: E. Blum & Co., 8044 Zürich
 Priorität: JP, 25.06.2004
 Beschreibung des Designs: Die Tintenfarbbandkassette wird in einem Gerät verwendet, das die Funktionen von Fax, Telefon, Kopierer und Drucker vereint.

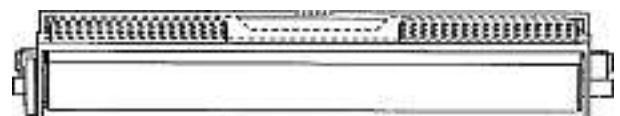

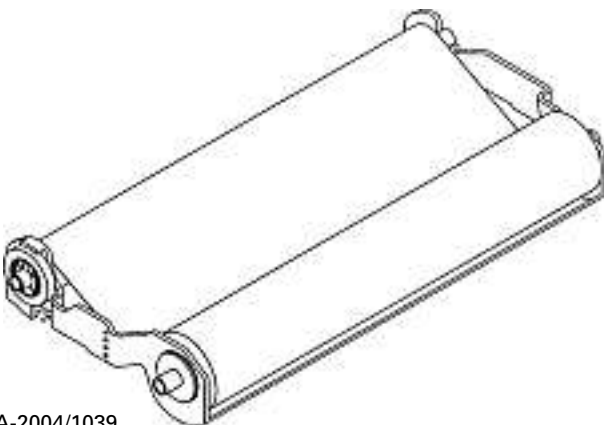
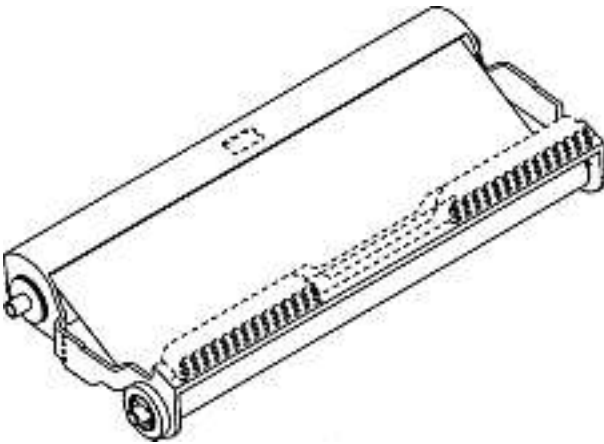
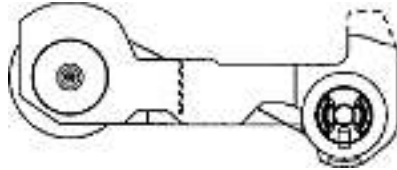
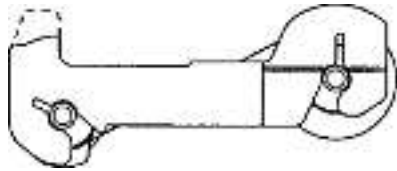
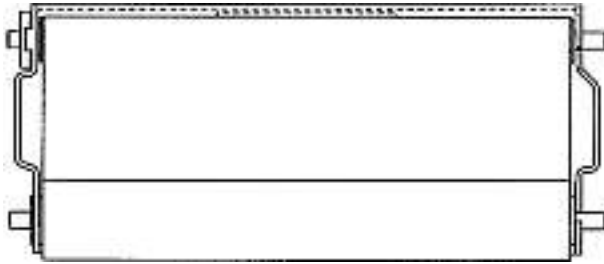
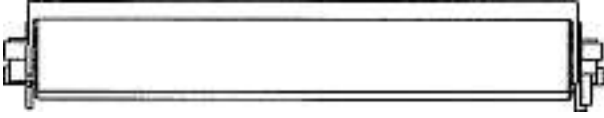
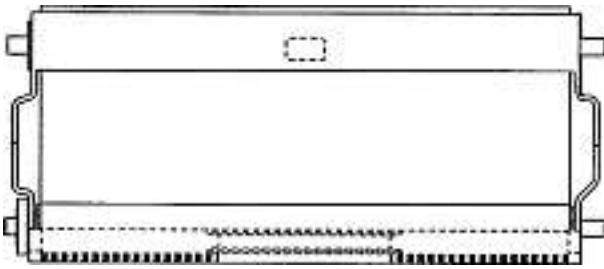

A-2004/1039

Cl. 19-04 **131 296** 03.11.2004
 5 Design – Sichtmappen
 Hinterleger: René Baltensperger, Chätzlerweg 10,
 8311 Brütten
 Vertreter: Hepp Wenger Ryffel AG, 9500 Wil SG
 1 (siehe Farbteil Heftmitte)
 2 (siehe Farbteil Heftmitte)
 3 (siehe Farbteil Heftmitte)
 4 (siehe Farbteil Heftmitte)
 5 (siehe Farbteil Heftmitte)

Cl. 19-06 **131 297** 11.11.2004
 4 Design – Schreibgeräte
 Hinterleger: MACMA Werbeartikel oHG, Thomas-Mann-
 Strasse 60, Nürnberg, DE
 Designer: Christian Huff, Neunkirchen am Sand
 Vertreter: Peter Rutz, 6304 Zug



1



2

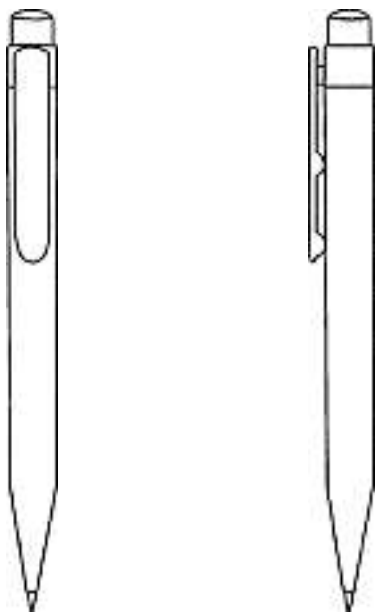

3

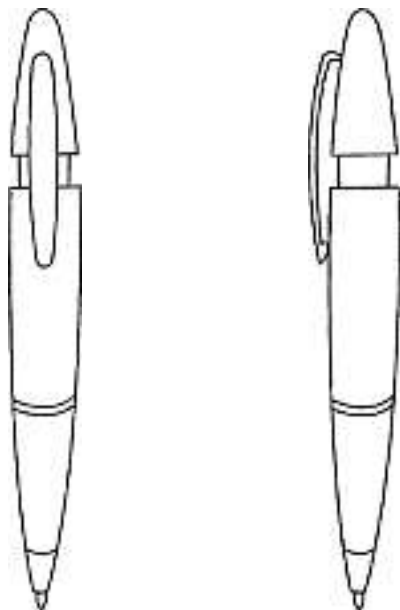

4

Cl. 19-08 **131 298** 29.09.2004
 3 Design – Etiketten
 Hinterleger: R & A Bailey & Co, Nangor House, Western Estate, Dublin 12, IE
 Designer: Richard Brandt, New York; Peter Knapp, London; Chris Hart, London; Matthew Scott, New York; Joanne Emery, London
 Vertreter: Isler & Pedrazzini AG, 8023 Zürich
 Priorität: EM, 16.04.2004; EM, 09.06.2004
 M12934/1 (siehe Farbteil Heftmitte)
 M12934/2 (siehe Farbteil Heftmitte)
 M12934/3 (siehe Farbteil Heftmitte)

Cl. 19-08 **131 299** 29.09.2004
 3 Design – Etiketten
 Hinterleger: R & A Bailey & Co, Nangor House, Western Estate, Dublin 12, IE
 Designer: Richard Brandt, New York; Peter Knapp, London; Chris Hart, London; Matthew Scott, New York; Joanne Emery, London
 Vertreter: Isler & Pedrazzini AG, 8023 Zürich
 Priorität: EM, 16.04.2004; EM, 09.06.2004



M12935/1



M12935/2



M12935/3

Cl. 20-02 **131 300** 15.12.2004
 2 design – vetrinetta da esposizione
 Depositante: Antara Sagl, Via Ponte di Valle 2, 6964 Davesco
 Designer: Arno Porta, Villa Luganese
 Mandatario: Fiammenghi-Fiammenghi, 6900 Lugano



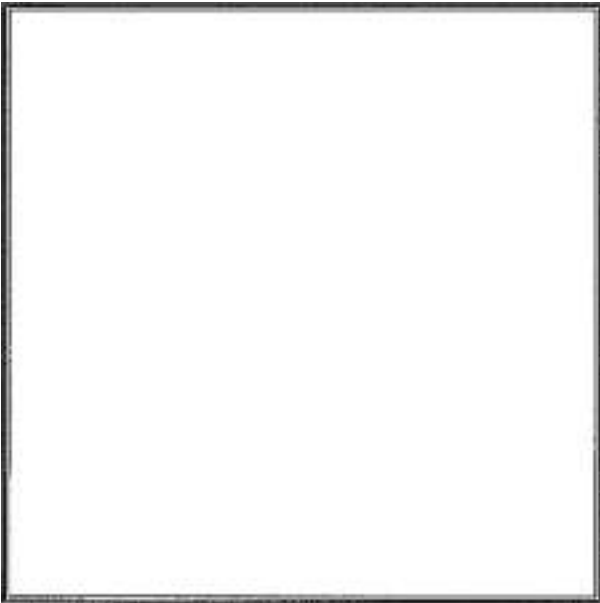

440/1

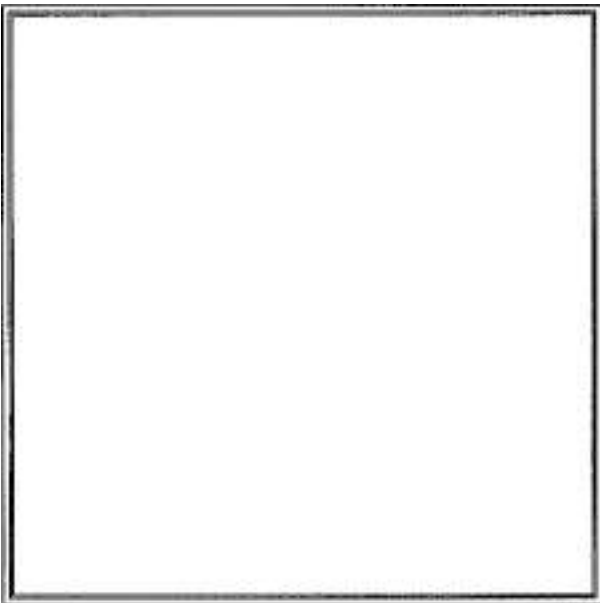

440/2

Cl. 20-02 **131 301** 06.01.2005
 1 Design – Displayauflage
 Hinterleger: Panther Packaging GmbH & Co. KG,
 Altonaer Strasse, 25436 Tornesch, DE
 Designer: Christian Benz, Grossbeeren
 Vertreter: E. Blum & Co., 8044 Zürich
 Priorität: EM, 13.12.2004
 A-2005/1004 (siehe Farbteil Heftmitte)

Cl. 21-02 **131 302** 10.11.2004
 4 design – décors de patins à glace
 Déposant: SPORT MASKA INC., 3500 de Maisonneuve Blvd.
 West, Suite 800, Westmount, Quebec H3Z 3C1, CA
 Designer: Luc Vachon, St-Jean-sur-Richelieu; Stephen
 Murphy, Montréal; Philippe Koyess, Montréal
 Mandataire: Micheli & Cie, 1226 Thônex (Genève)
 Priorité: CA, 16.07.2004



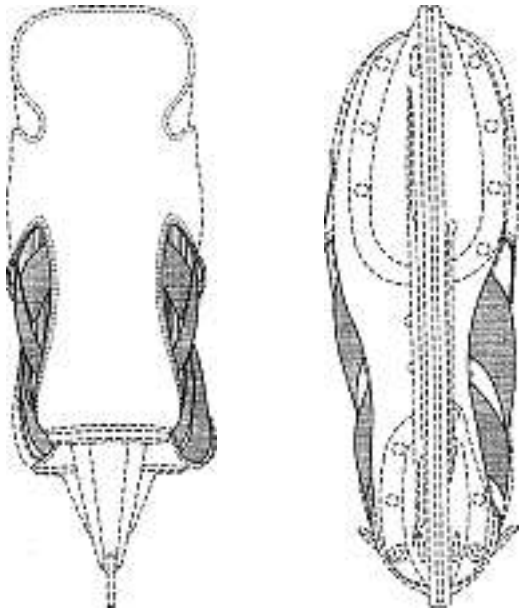
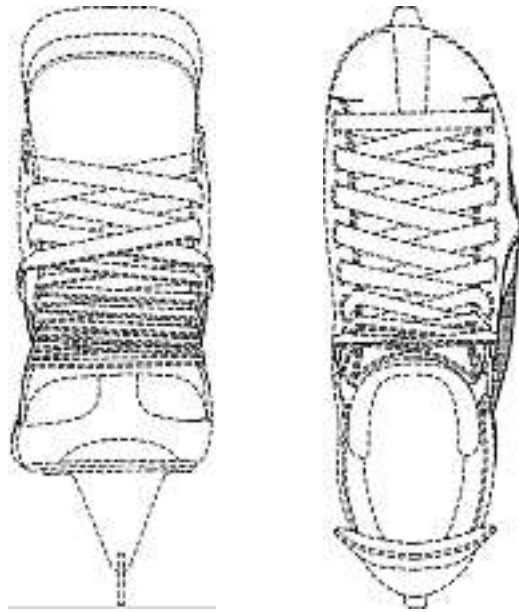

14349A

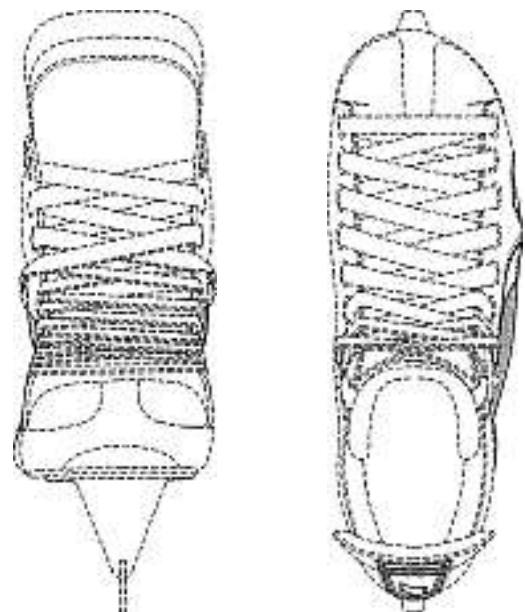
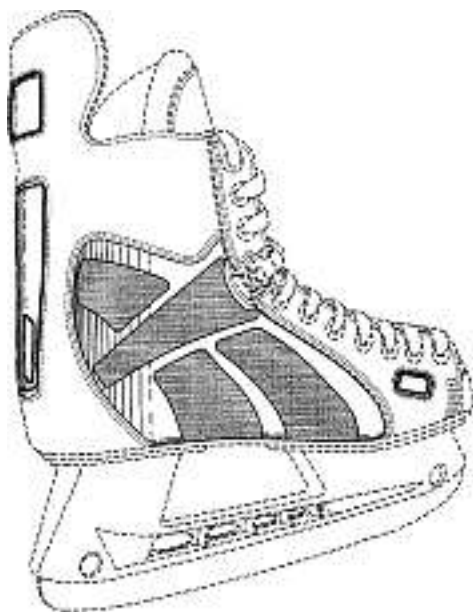

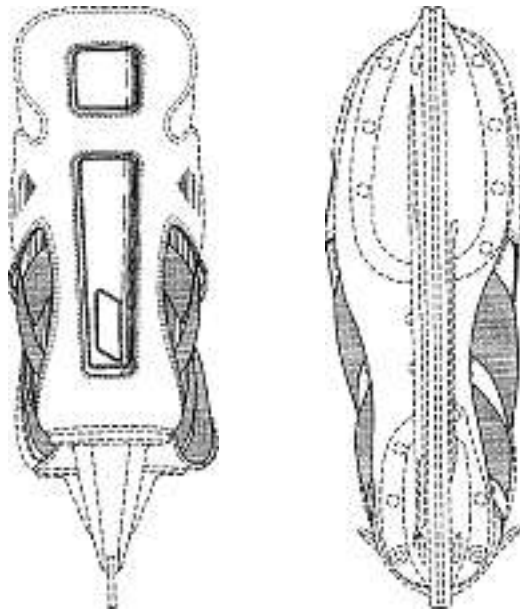

14349B

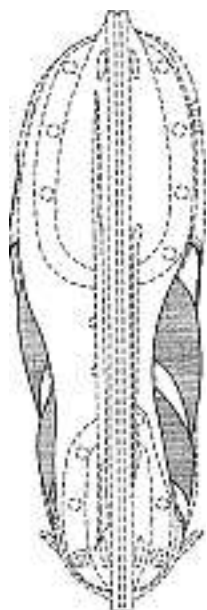
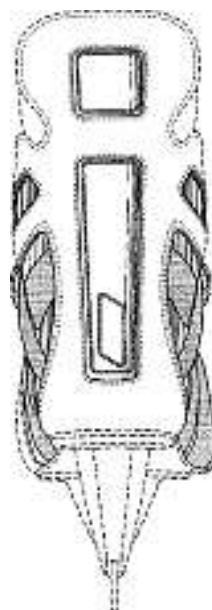
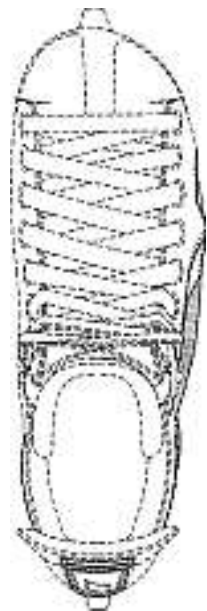
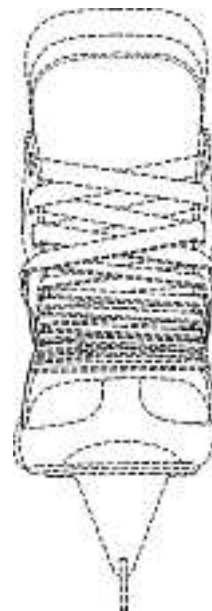

14349C

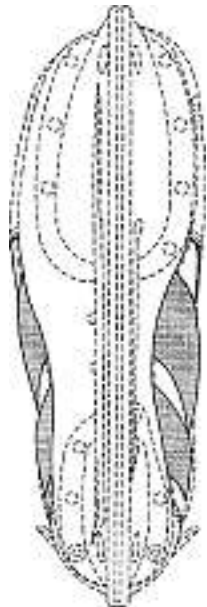
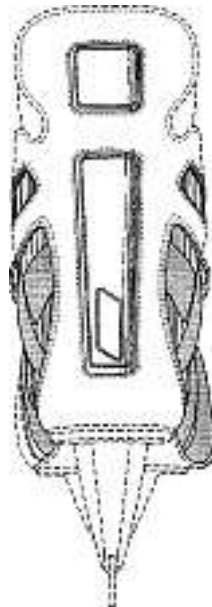
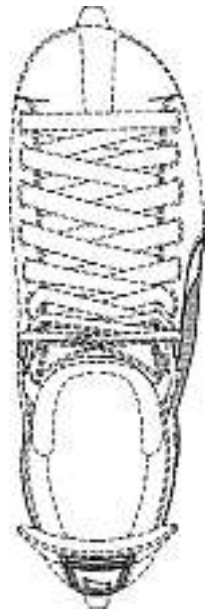
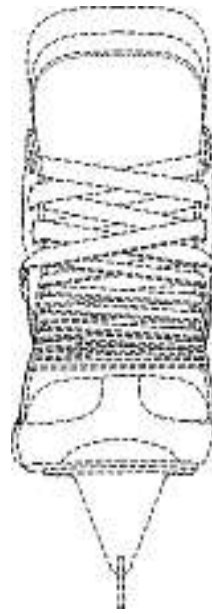
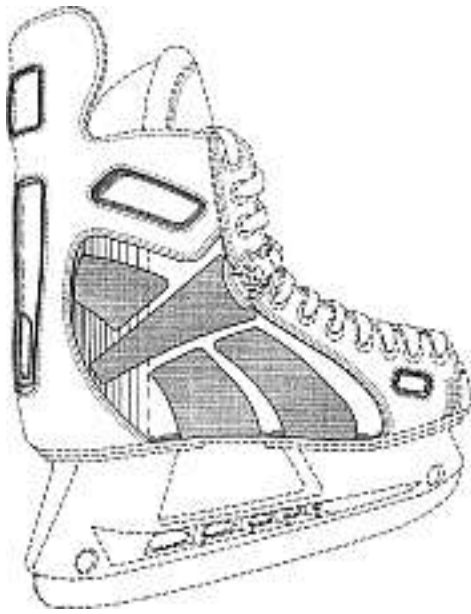

14349D

Cl. 23-02 **131 303** 21.12.2004
 2 Design – Kabine
 Hinterleger: Physiotherm GmbH, B. Köllenspergerstrasse 1,
 Thaur, AT
 Designer: Luis Schwarzenberger, Lans; Josef Gunsch, Mils
 Vertreter: Isler & Pedrazzini AG, 8023 Zürich
 Priorität: EM, 22.06.2004

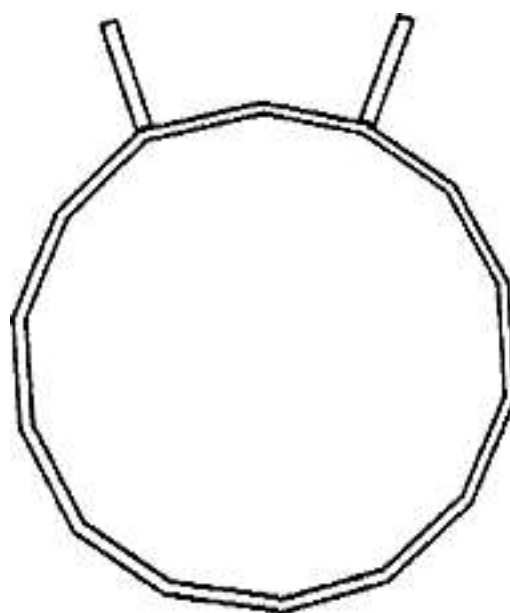
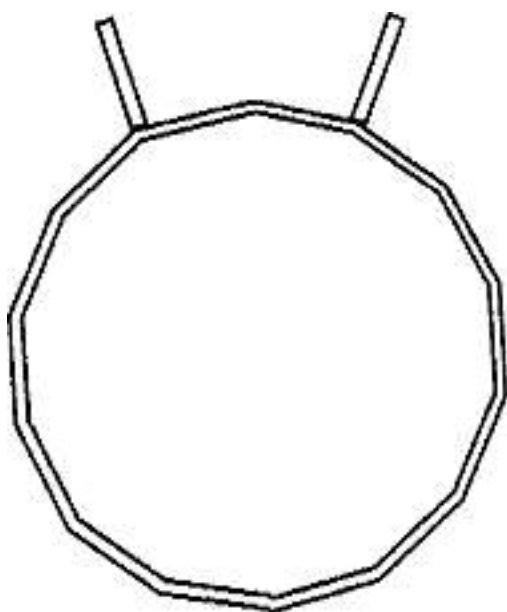
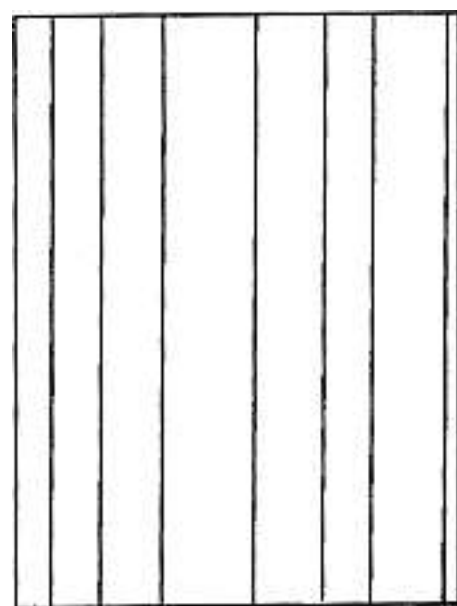
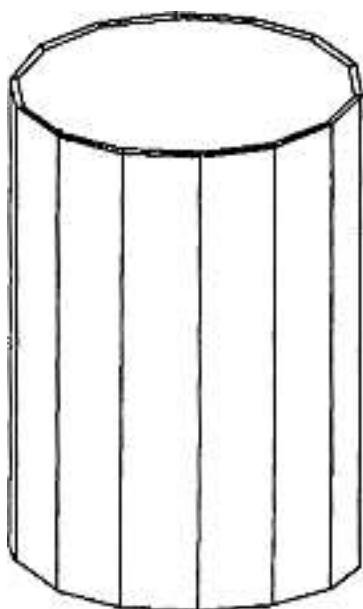
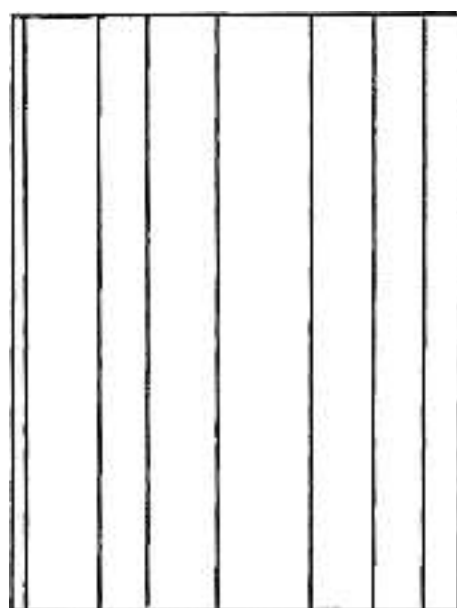
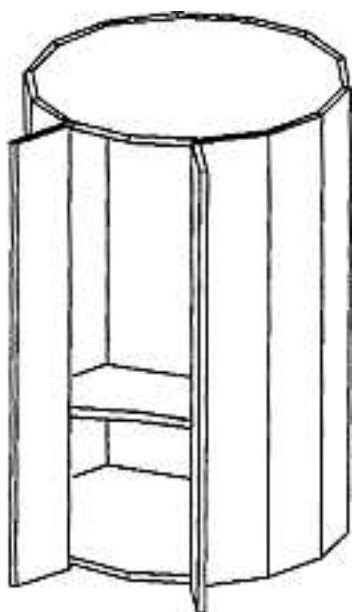

M12973/1

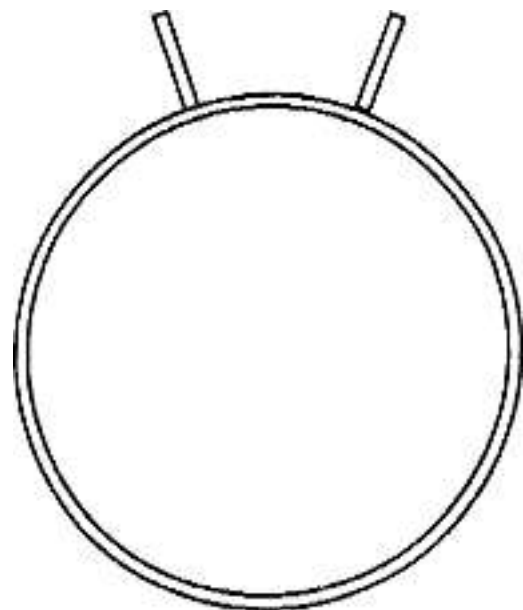
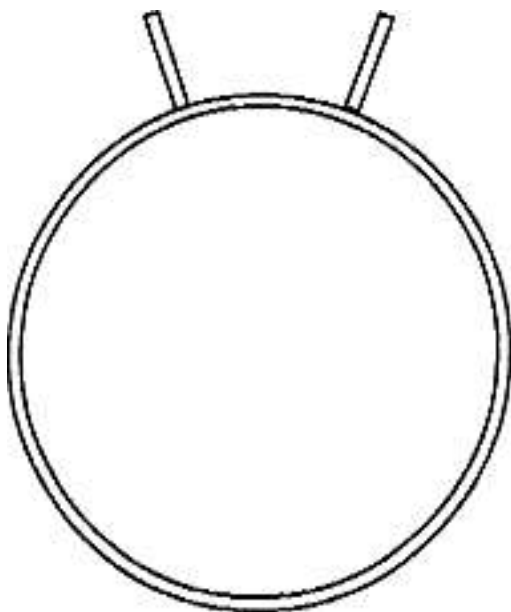
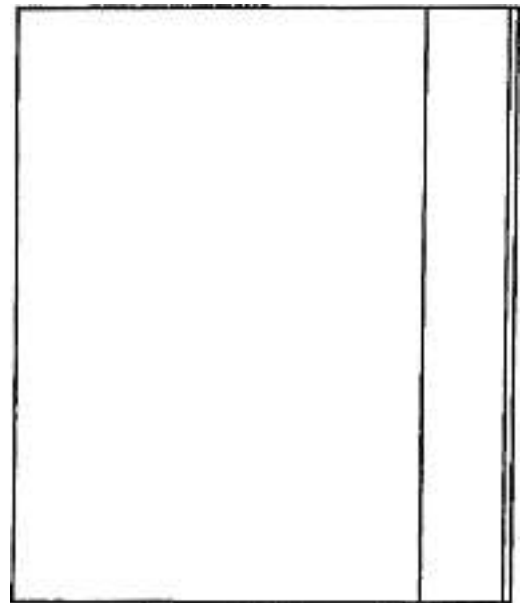
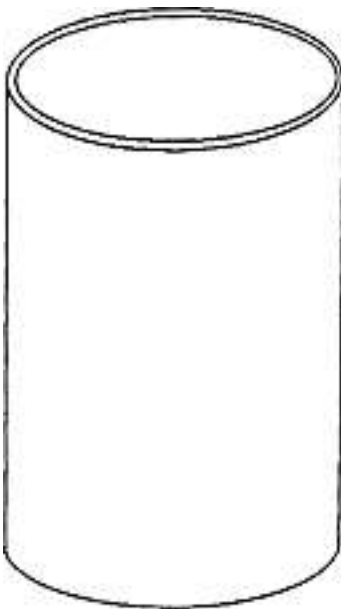
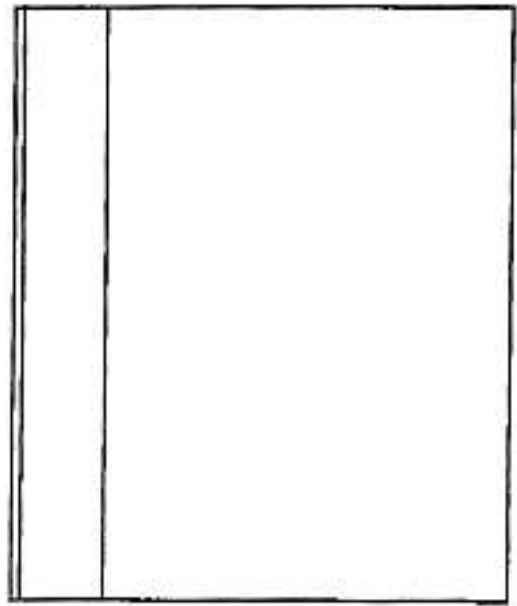
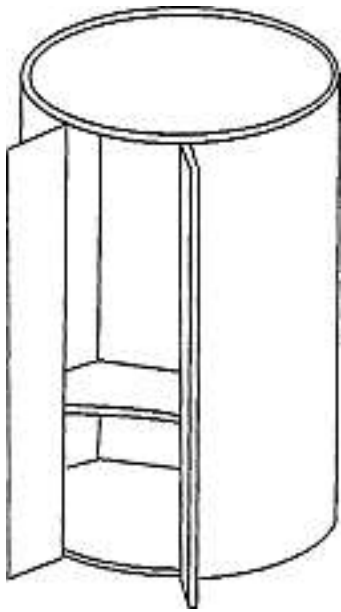

M12973/2

Cl. 24-03 **131 304** 23.12.2004
 5 Design – Kniegelenk für Prothese, Orthese, Orthesengestell
 Hinterleger: Otto Bock HealthCare GmbH,
 Max-Näder-Strasse 15, 37115 Duderstadt, DE
 Designer: Herman Boiten, Göttingen;
 Andreas Mühlenberend, Leipzig
 Vertreter: Braun & Partner, 4054 Basel
 Priorität: EM, 28.06.2004
 1 (siehe Farbteil Heftmitte)
 2 (siehe Farbteil Heftmitte)
 3 (siehe Farbteil Heftmitte)
 4 (siehe Farbteil Heftmitte)
 5 (siehe Farbteil Heftmitte)

Cl. 25-01 **131 305** 06.12.2004
 10 design – profilati estrusi
 Depositante: Marino Bernasconi, Via Prada 41, 6982 Agno
 Mandatario: Fiammenghi-Fiammenghi, 6900 Lugano

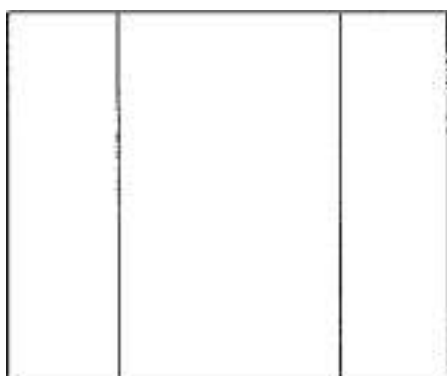
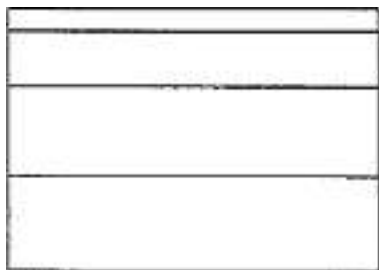
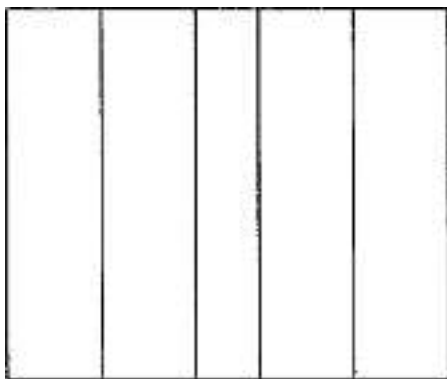

1

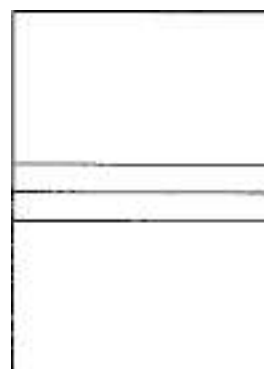
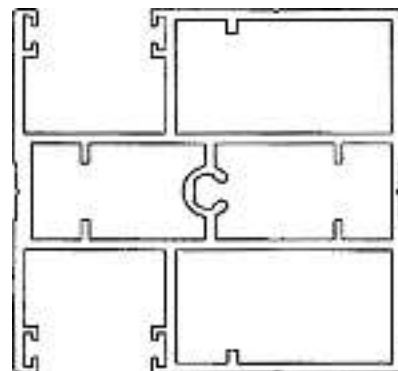
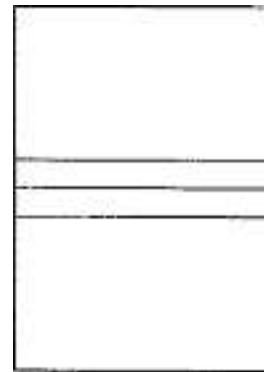

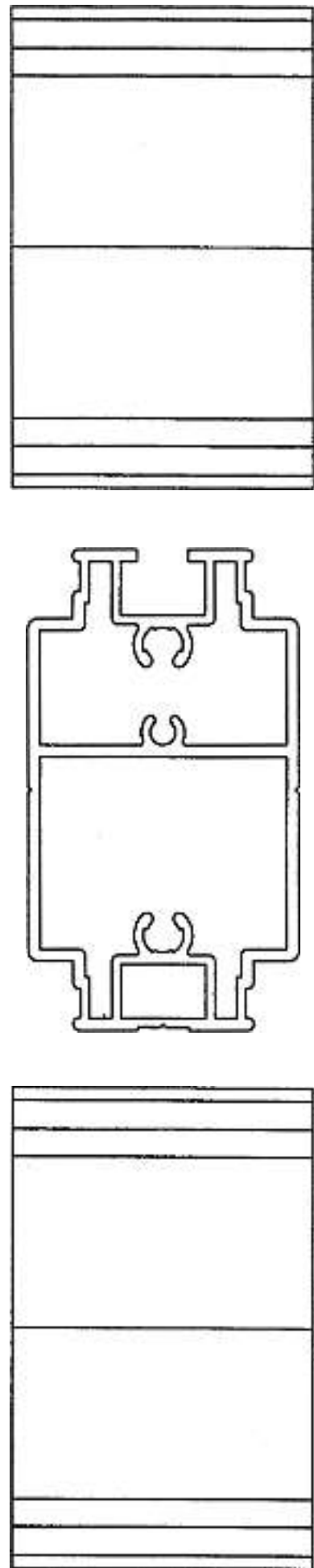
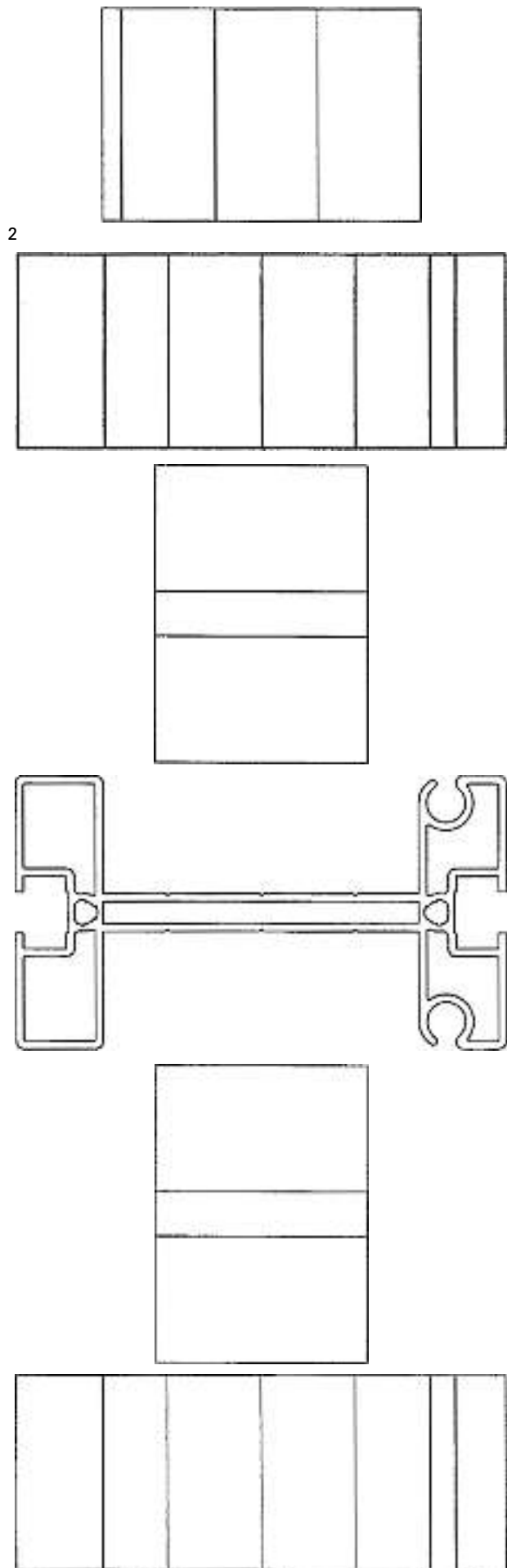

3

4

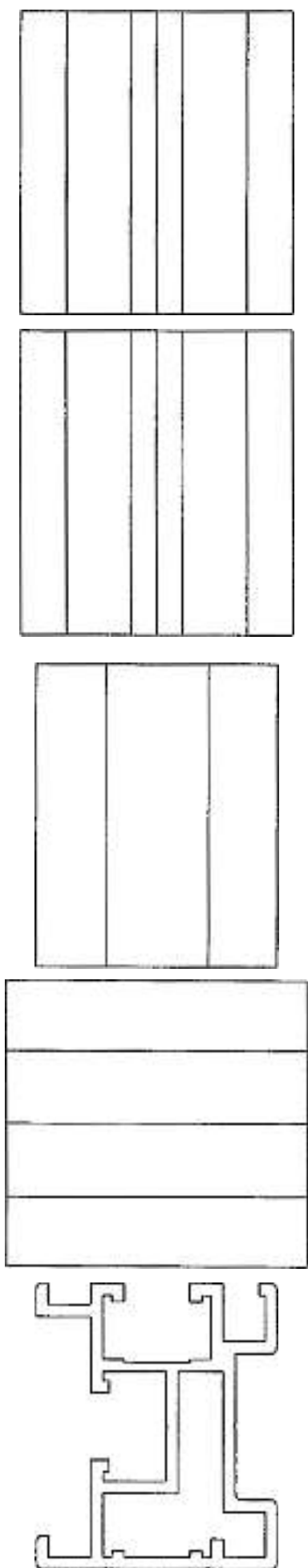

5

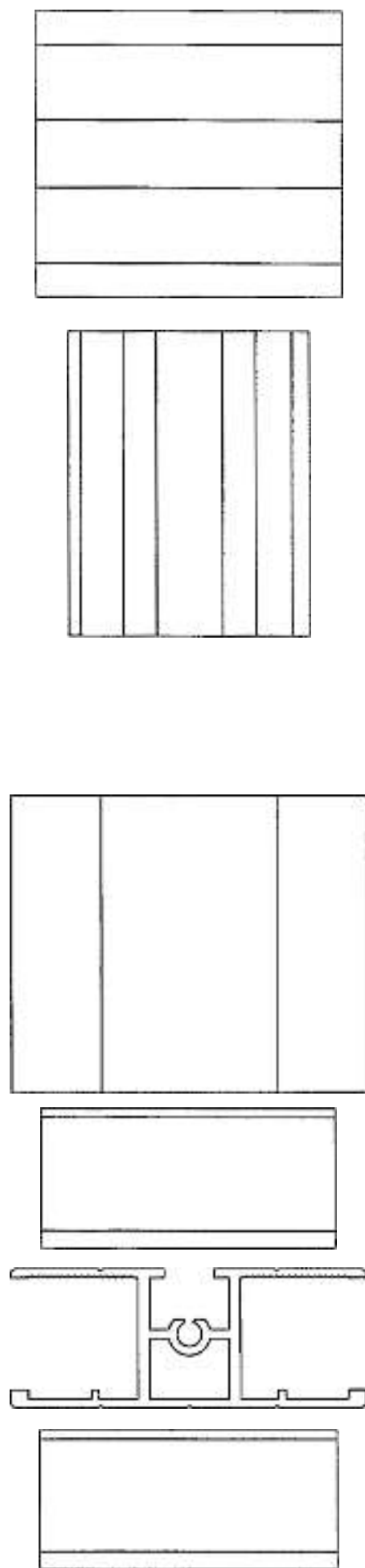

6

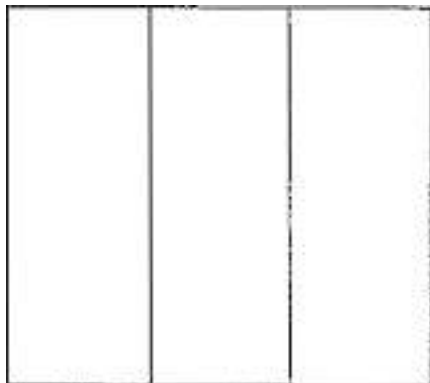
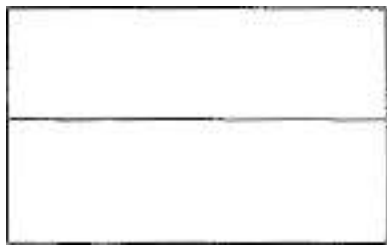
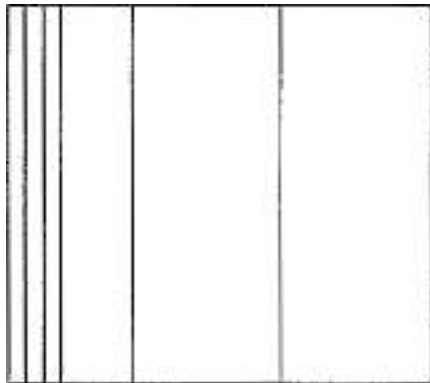
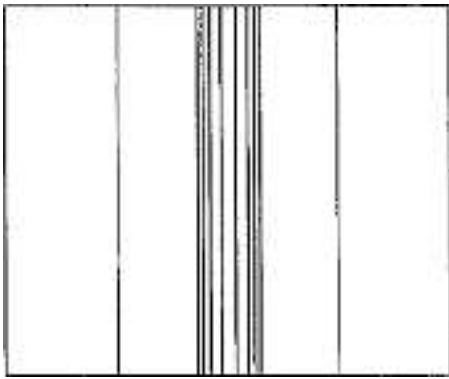

7

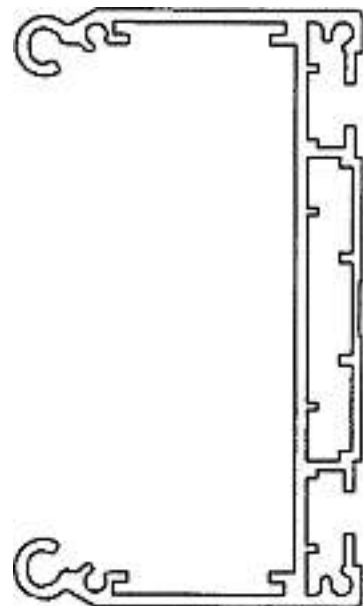
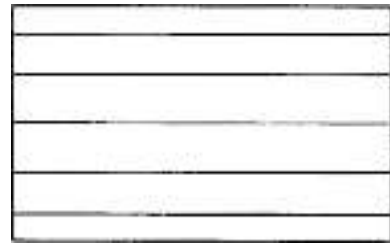

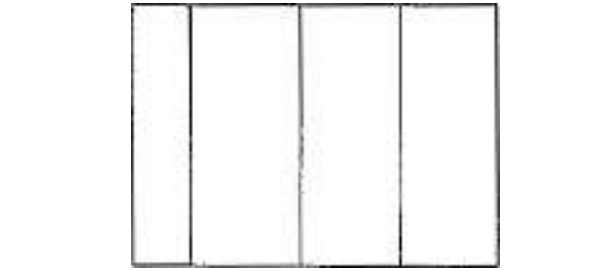

8

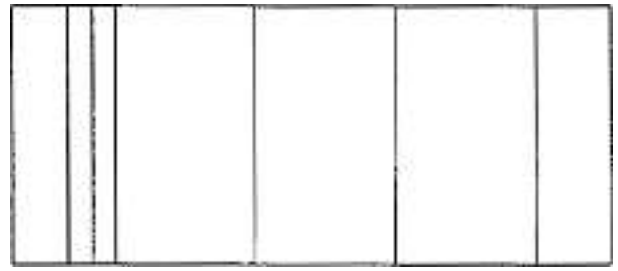
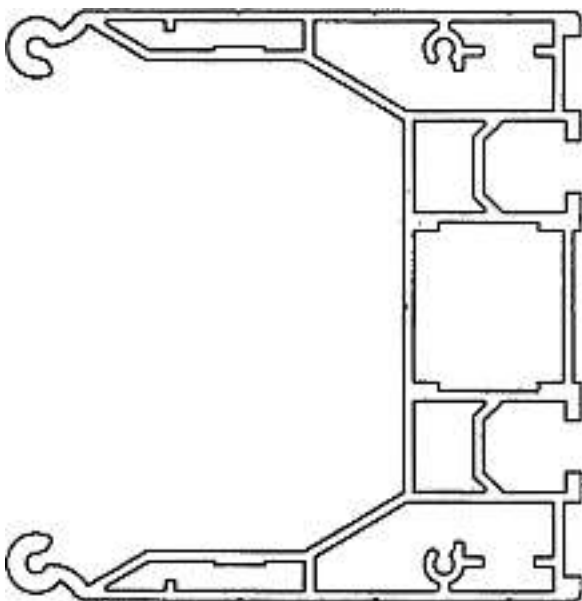
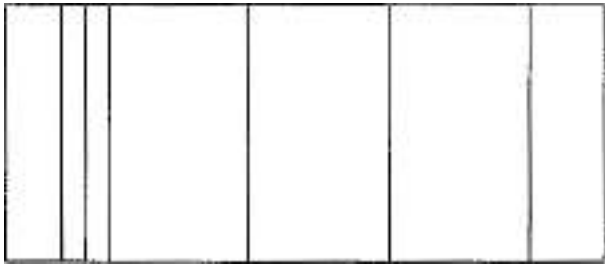

9

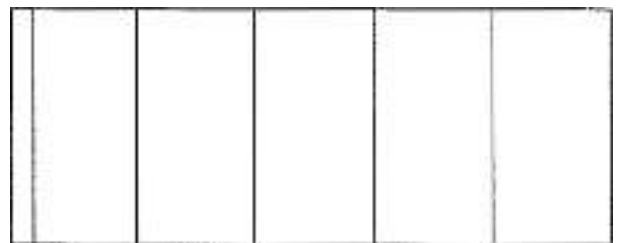
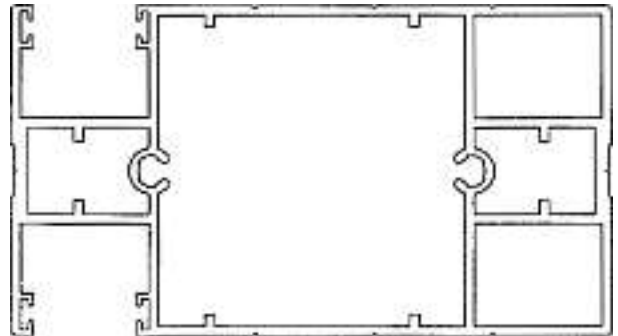
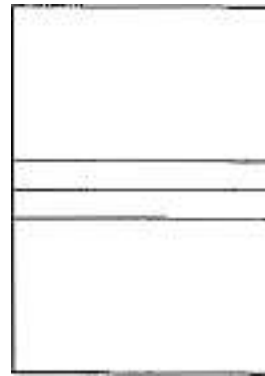
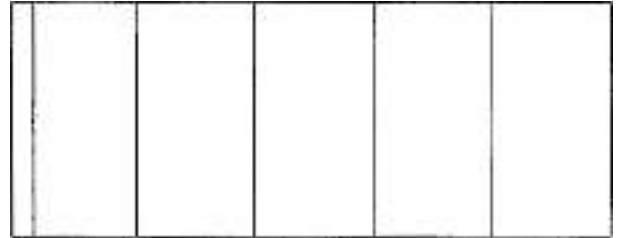

10

Cl. 25-02 **131 306** 02.12.2004
 1 Design – Haltevorrichtung für Fassadenverkleidungs-
 elemente
 Hinterleger: Walter Meusburger, Alpstrasse 17, Lustenau, AT
 Vertreter: Patentanwälte Feldmann & Partner AG, 8152
 Glattbrugg
 Priorität: AT, 07.06.2004

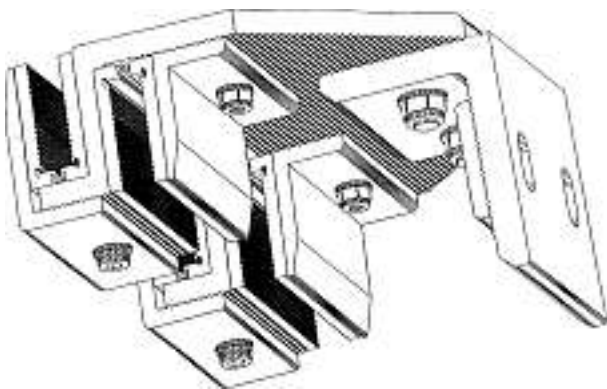
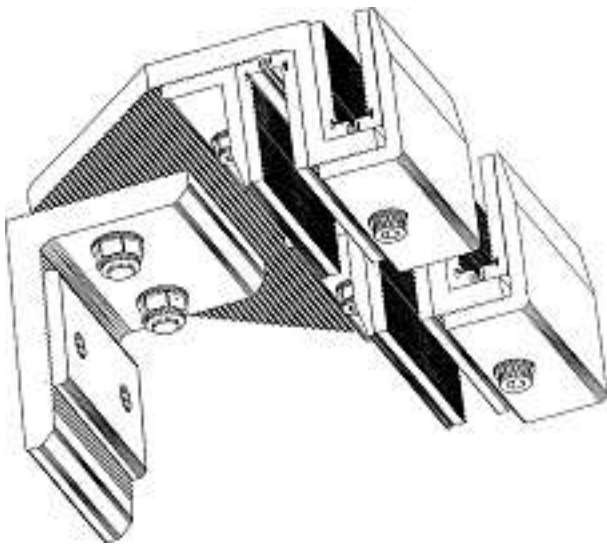
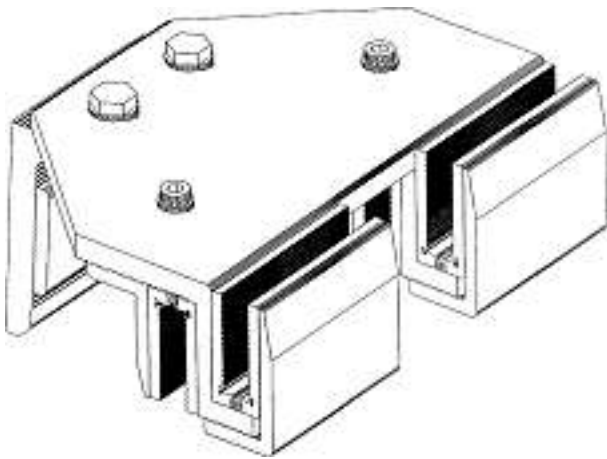

1

Cl. 25-03 **131 307** 24.11.2004
 1 Design – Bauten
 Hinterleger: NH Hoteles, S.A., Santa Engracia, 120,
 28003 Madrid, ES
 Designer: Catherine Grenier, Madrid
 Vertreter: Isler & Pedrazzini AG, 8023 Zürich
 Priorität: EM, 27.05.2004
 M12959 (siehe Farbteil Heftmitte)

Cl. 26-04 **131 308** 19.11.2004
 3 design – Lampes
 Déposant: Mass Technology (HK) Limited, Room 2902-6,
 Tower 6, the Gateway, 9 Canton Road, Tsimshatsui,
 Kowloon, HK
 Designer: Onn Fah Foo, Kowloon
 Mandataire: Bugnion S.A., 1211 Genève 12 – Champel
 Priorité: HK, 14.09.2004; HK, 14.09.2004; HK, 14.09.2004

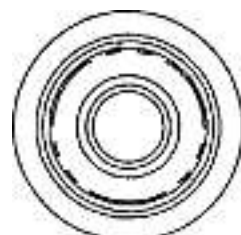
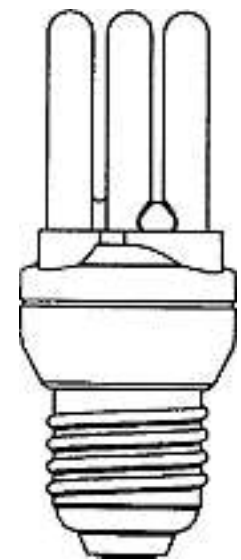
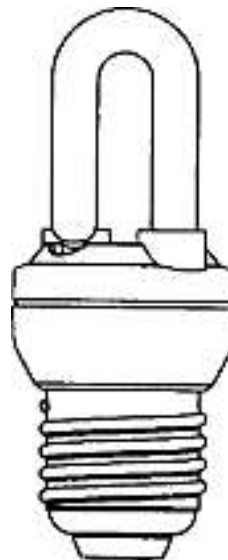
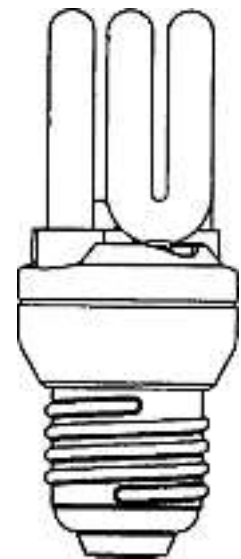
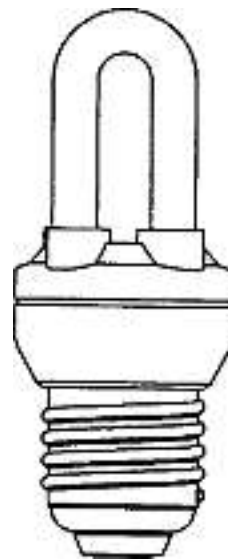
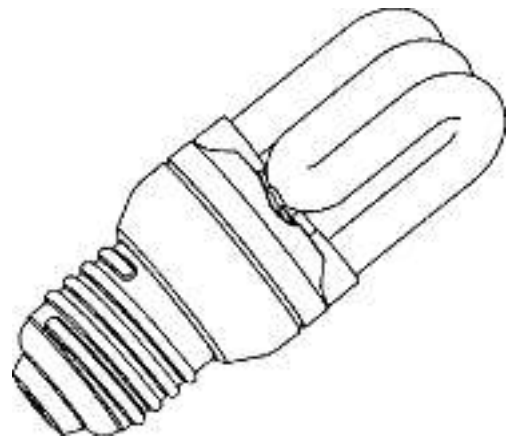

1

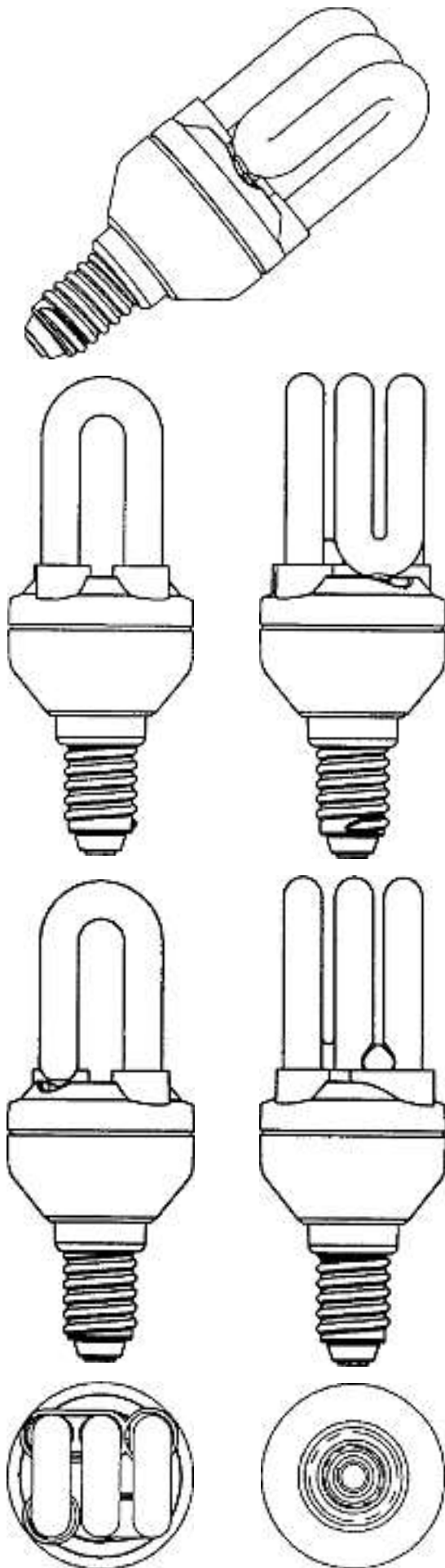

2

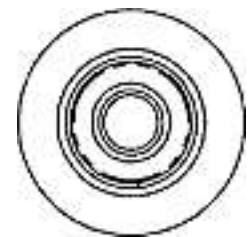
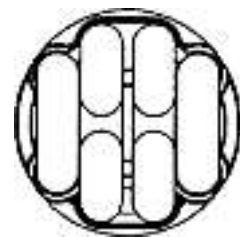
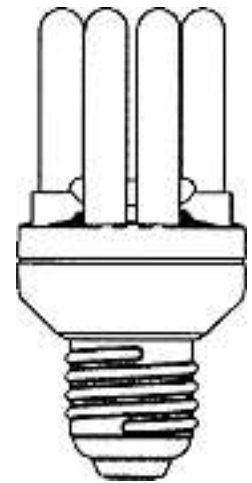
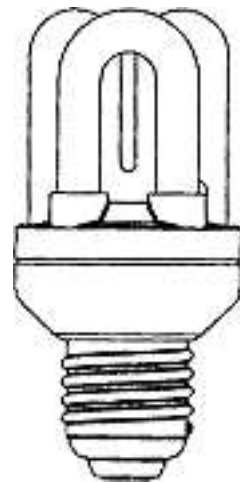
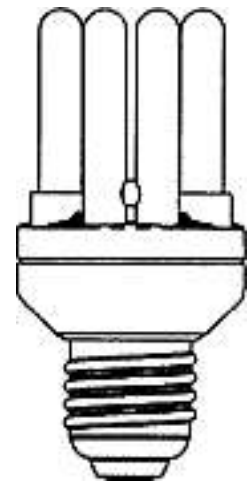
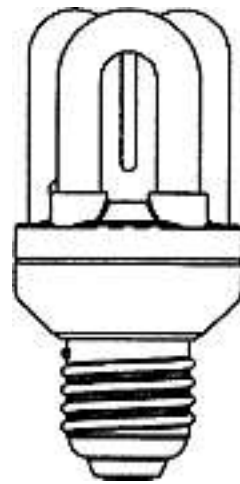
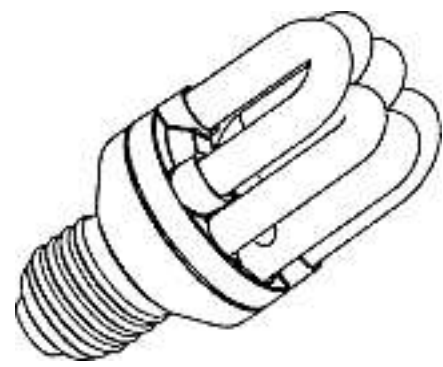

3

Cl. 26-05 **131 309** 22.12.2004
 13 Design – Beleuchtungsapparate
 Hinterleger: iGUZZINI ILLUMINAZIONE S.p.A., Via Mariano
 Guzzini 37, Recanati, Macerata, IT
 Designer: Giannunzio Guzzini, Recanati
 Vertreter: Bovard AG, 3000 Bern 25
 Priorität: EM, 23.06.2004

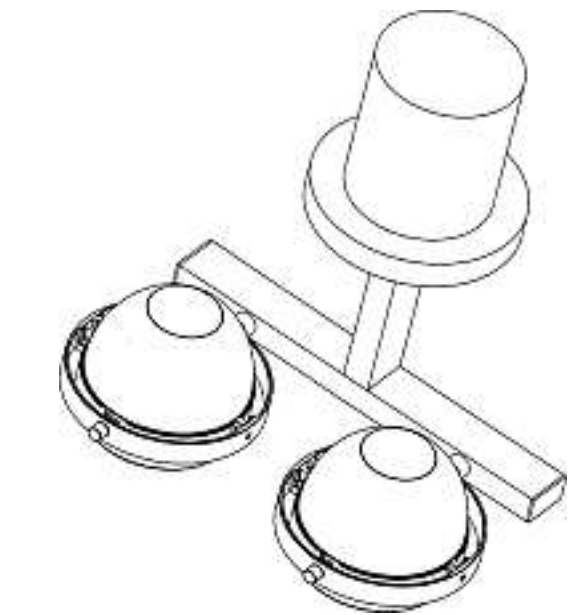
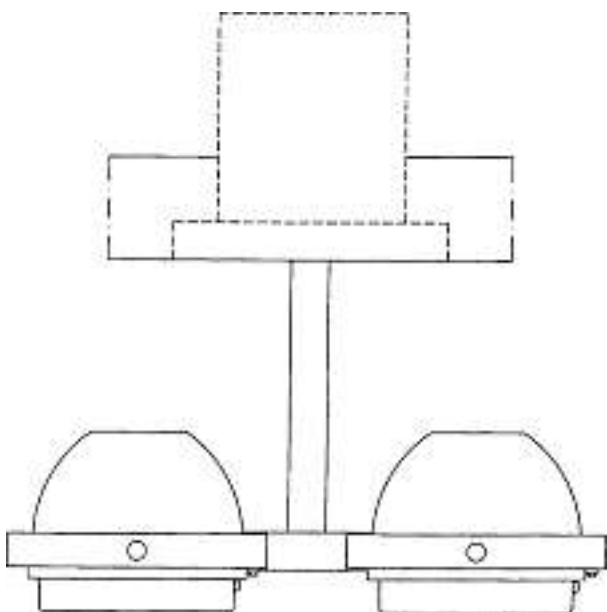
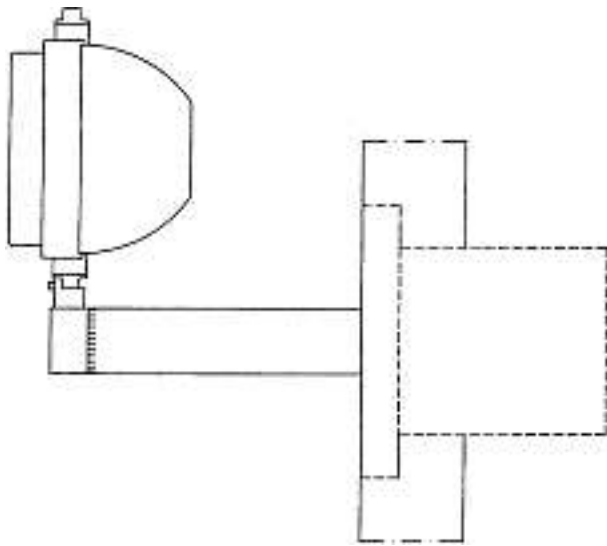
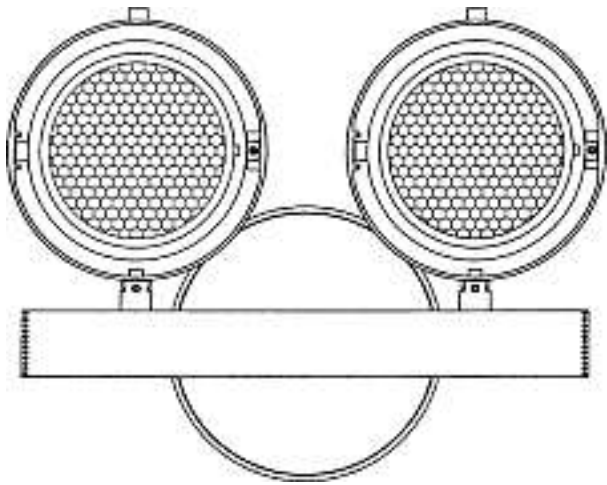

1

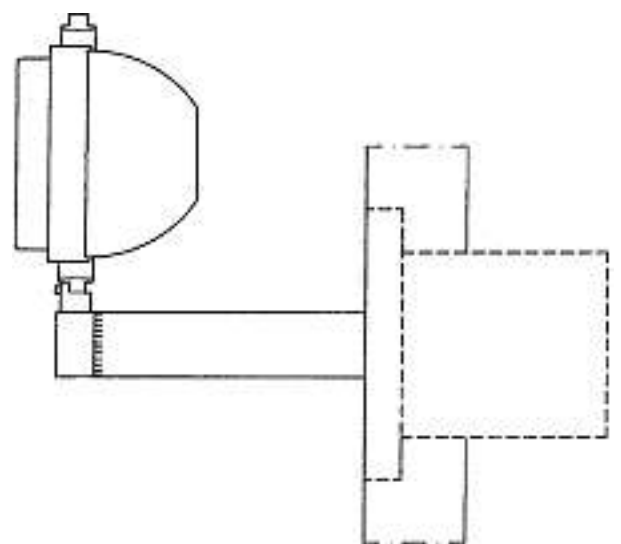

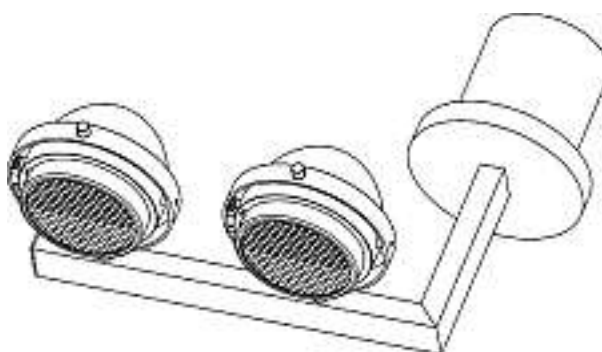
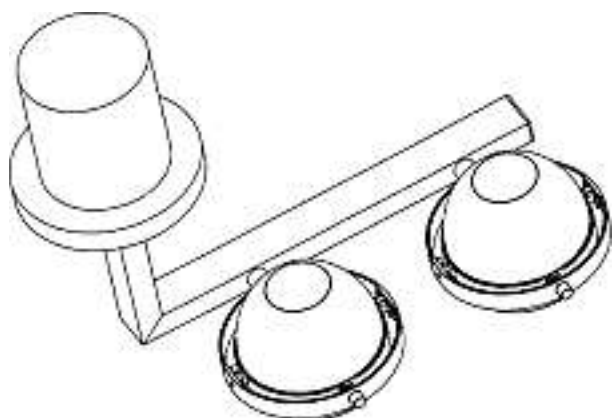
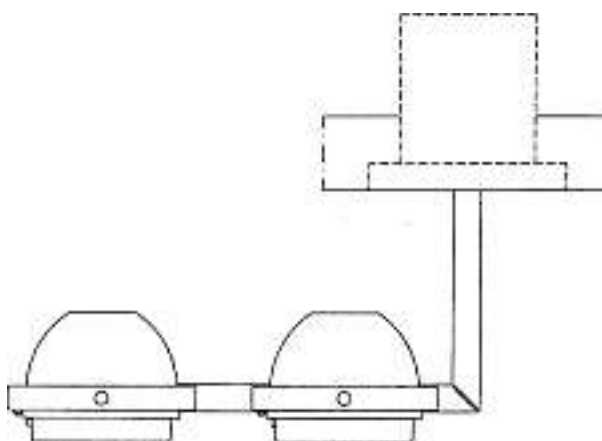
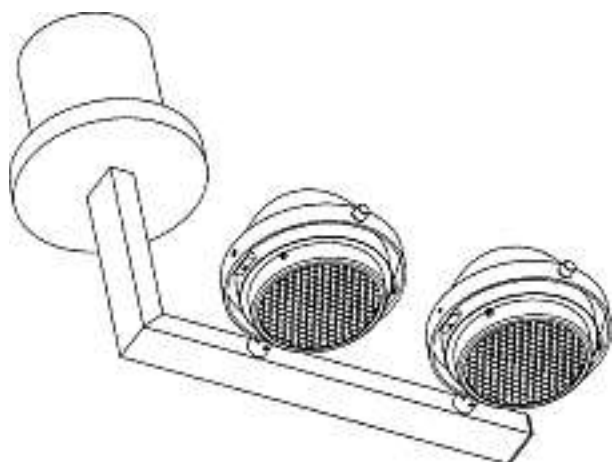
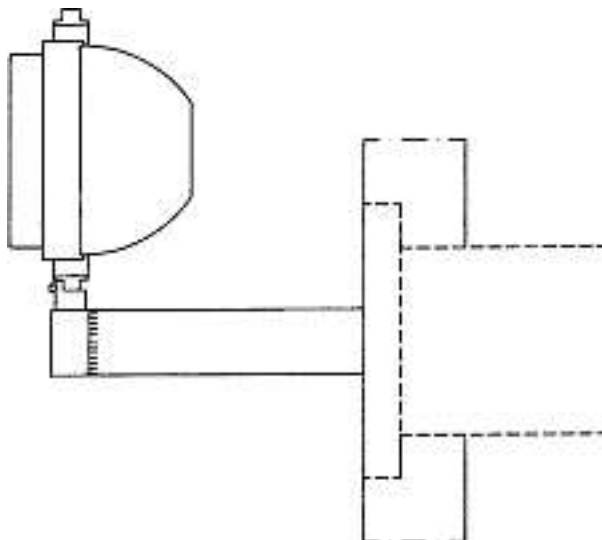
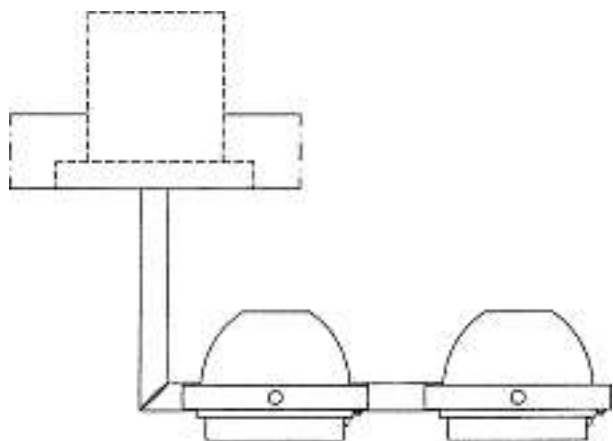
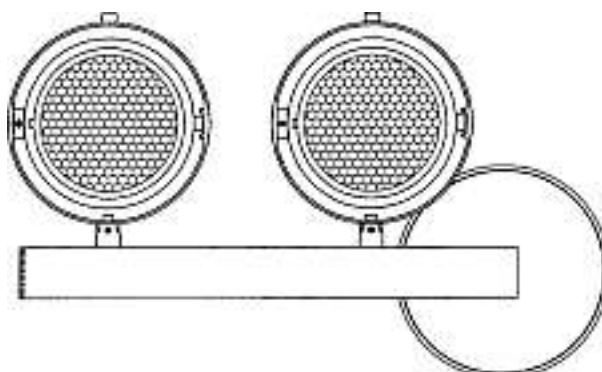
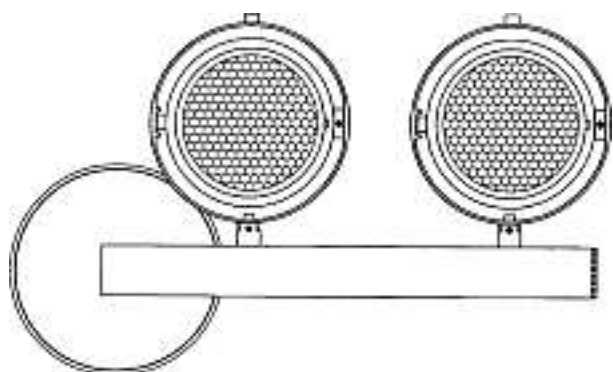

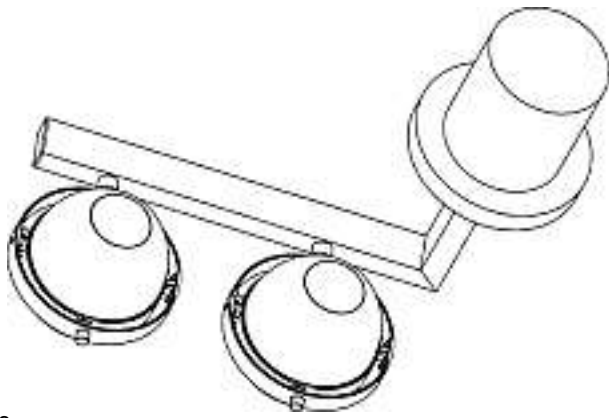

3

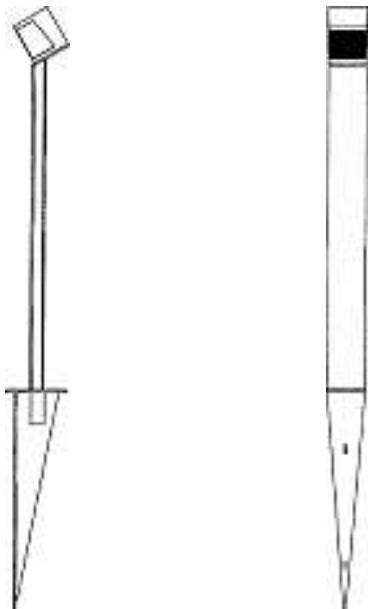
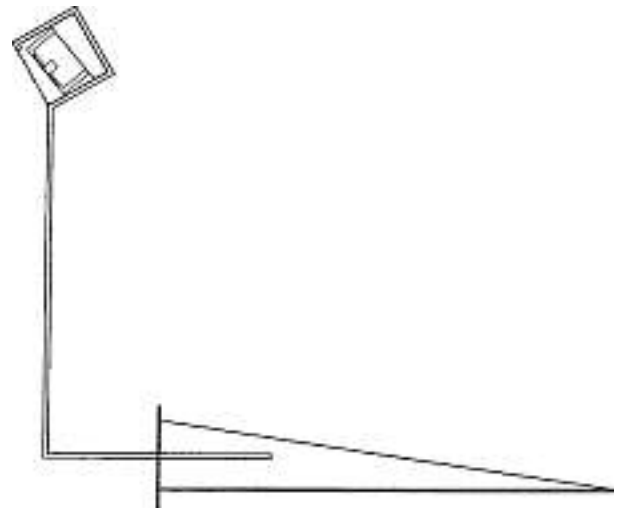

5

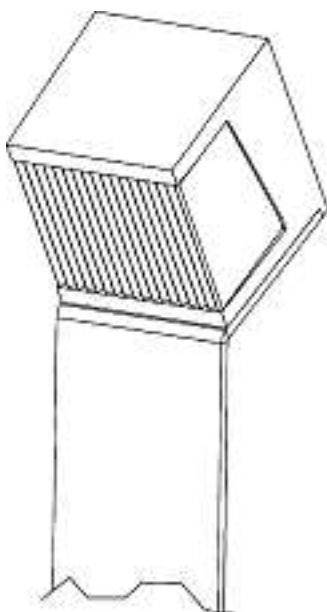
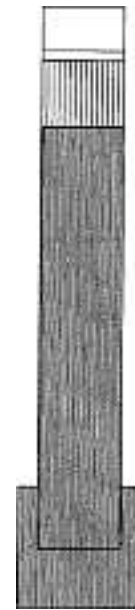

4

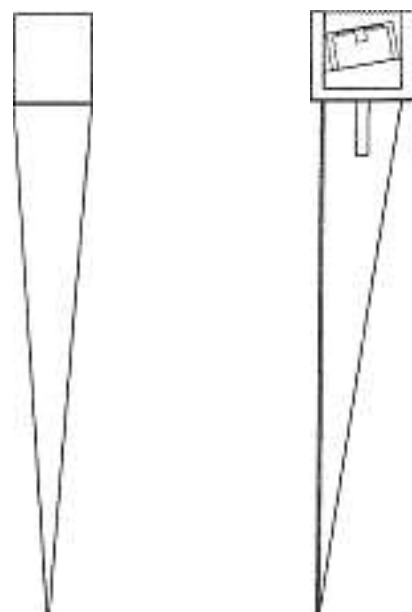

6

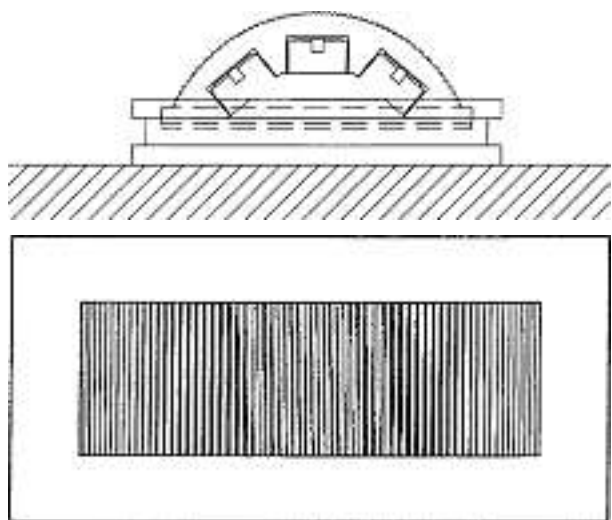

7

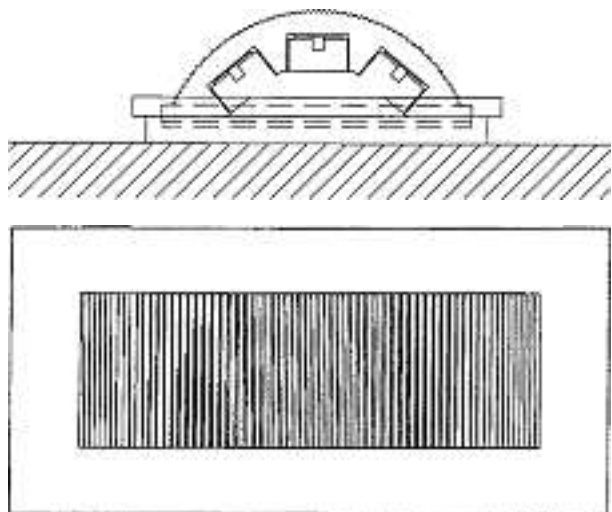

8

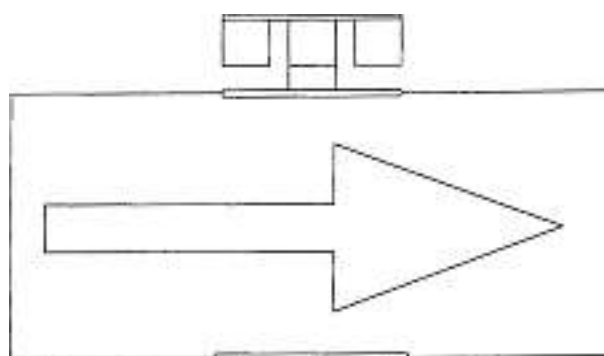
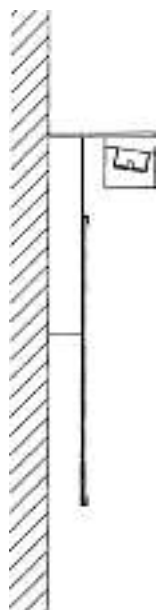

9

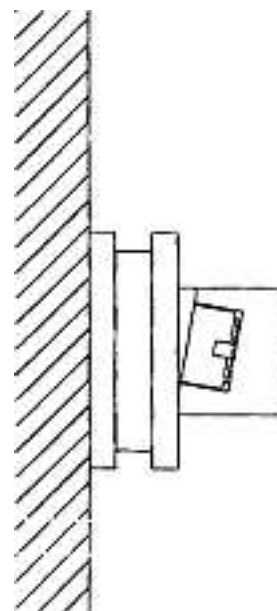
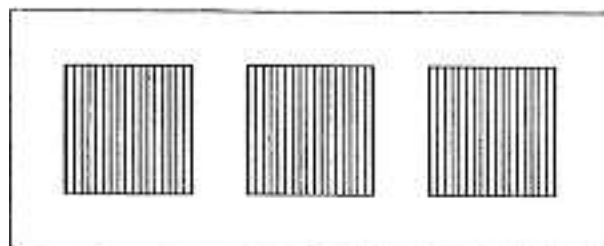

10

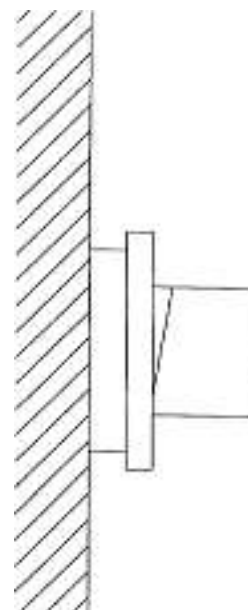

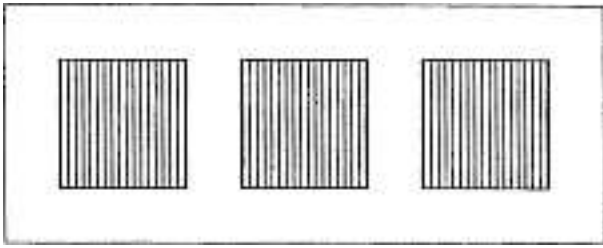

11

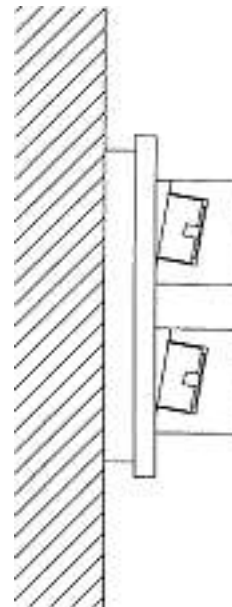
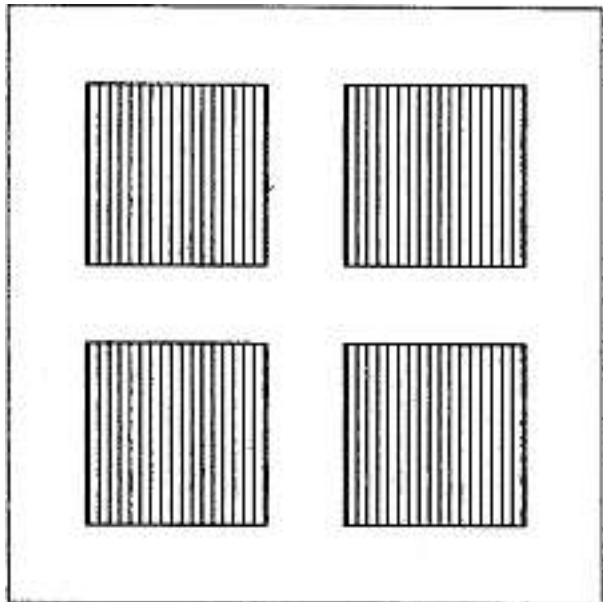
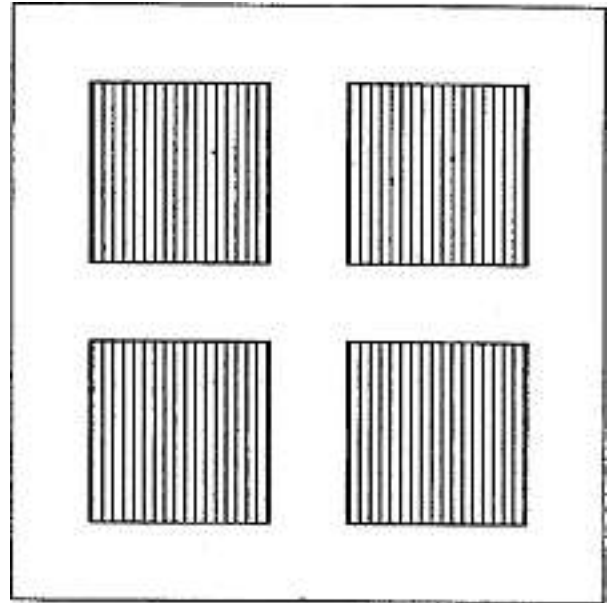

13

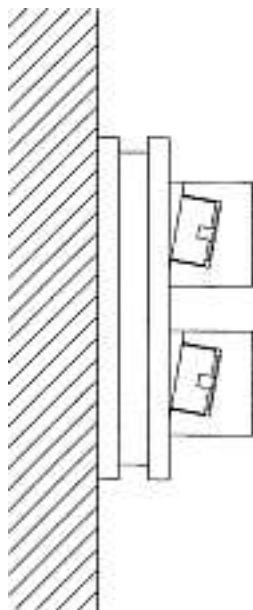

12

Cl. 30-99 **131 310** 12.11.2004
 6 Design – Haustierklappe und Haustierklappe mit
 Bemusterungen
 Hinterleger: Reilor Holdings Limited, Astra Business Centre,
 Roman Way, Preston PR2 5AP, GB
 Designer: Paul Grundy, Manchester
 Vertreter: Bovard AG, 3000 Bern 25
 Priorität: EM, 14.05.2004; EM, 14.05.2004

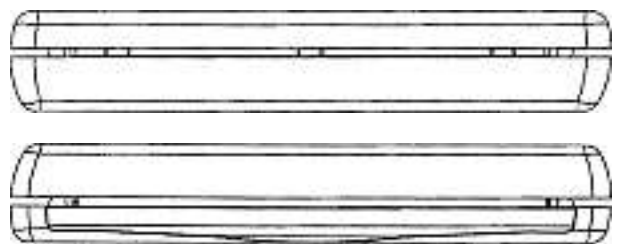

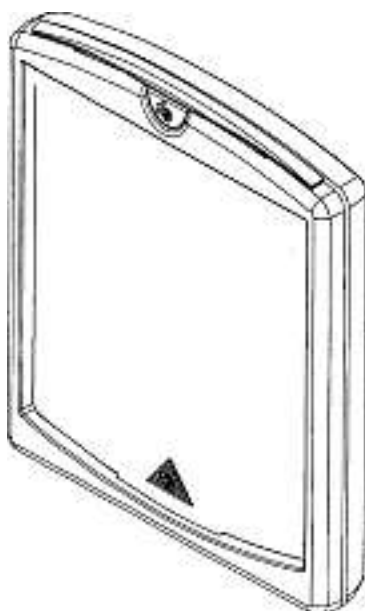
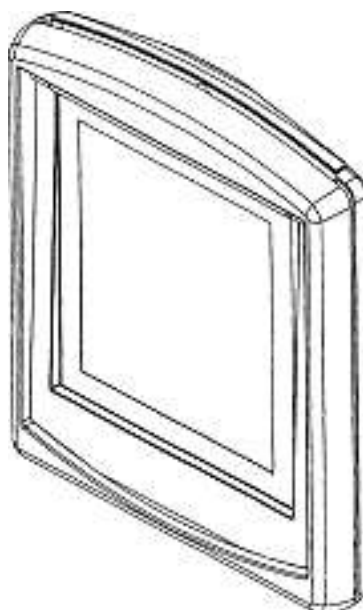
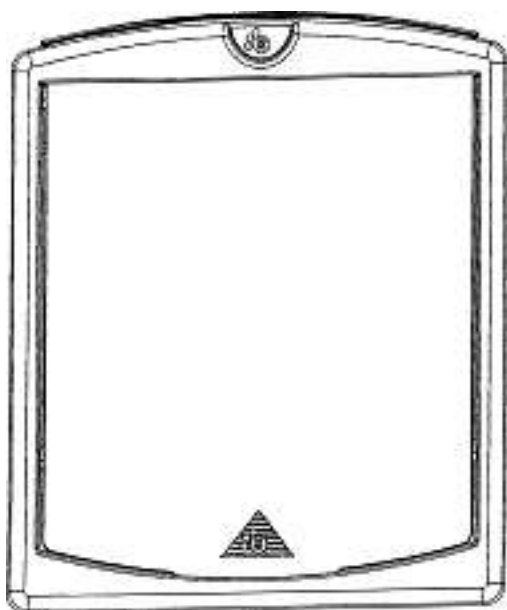

300430/1

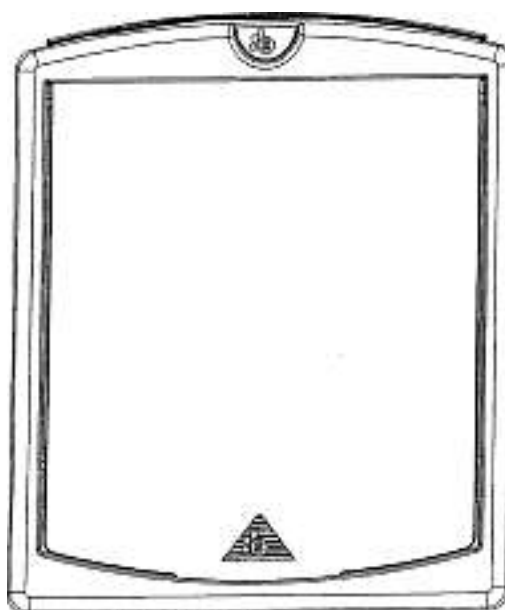
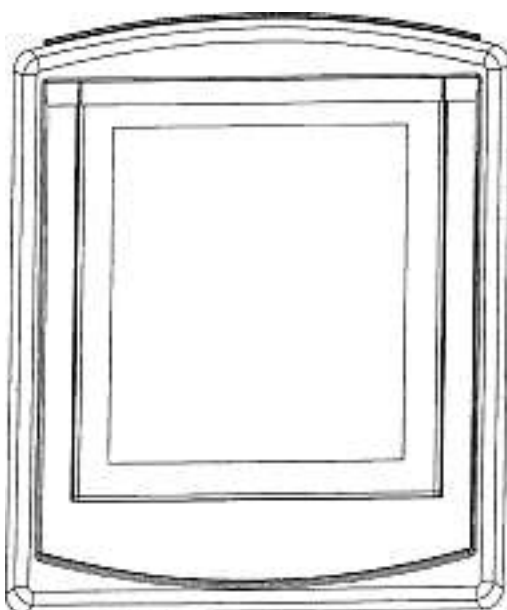

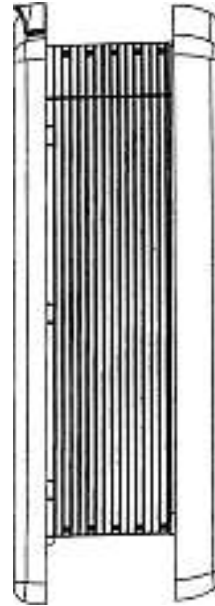
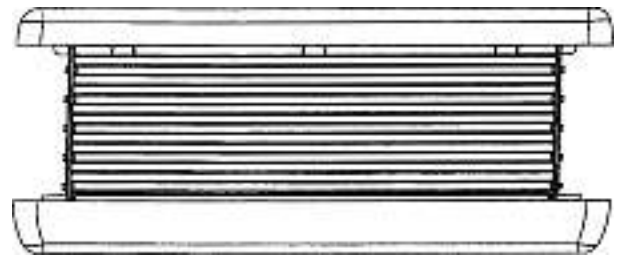
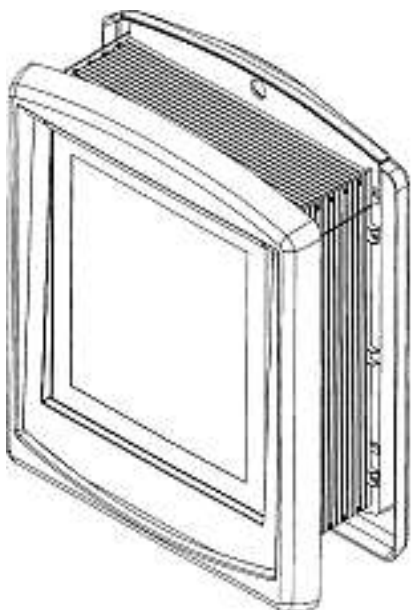
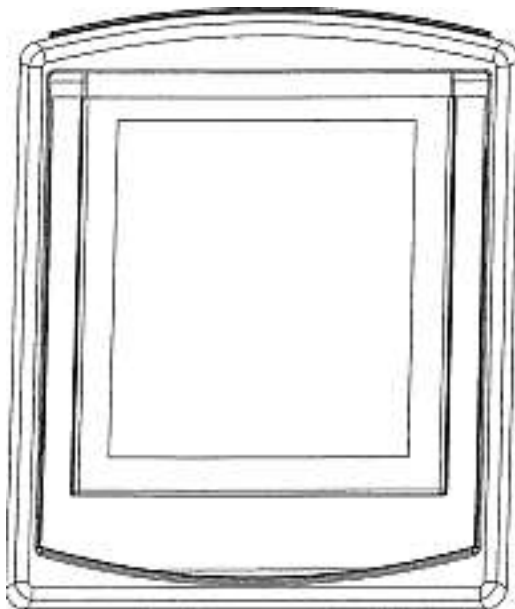
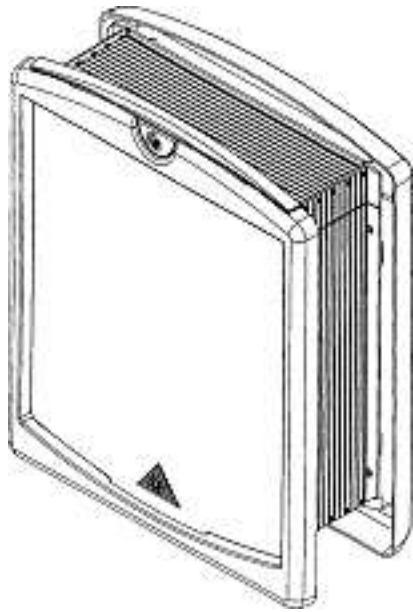

300430/2

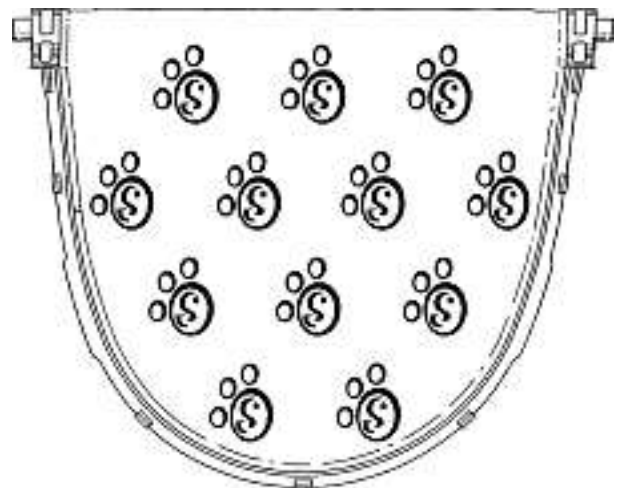

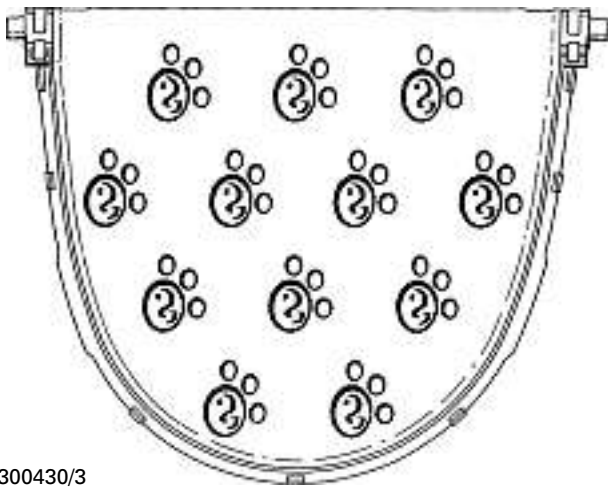

300430/3



300430/4

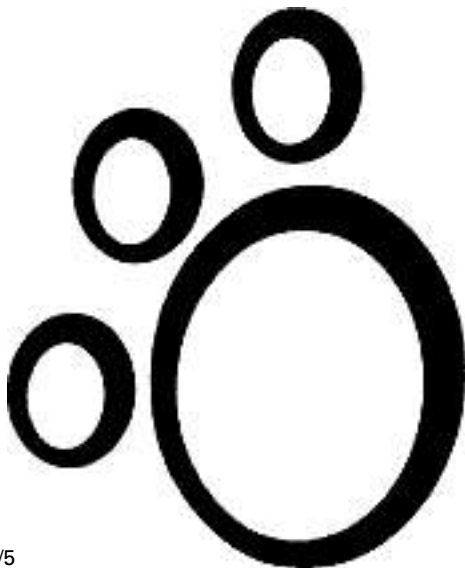

300430/5



300430/6

Cl. 31-00 131 311 05.01.2005
 1 design – distributeur (automatique) de boissons
 Déposant: Société des Produits Nestlé SA, 1800 Vevey
 Designer: Tim Whateley, Leicester
 Mandataire: Nestec S.A., 1800 Vevey

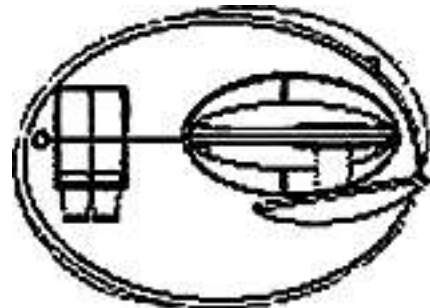
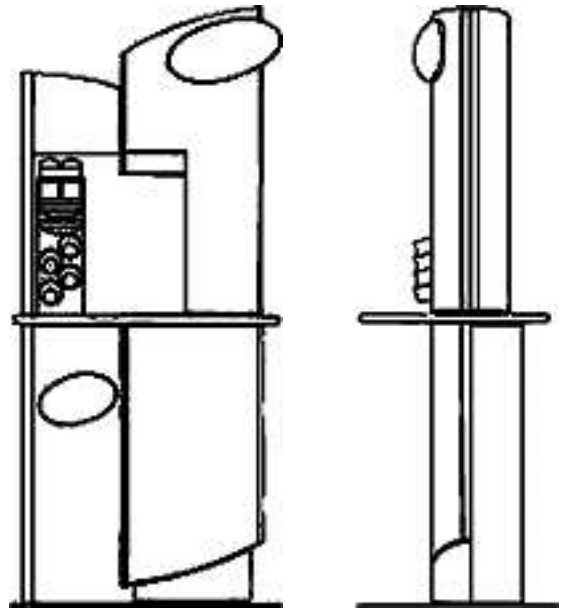
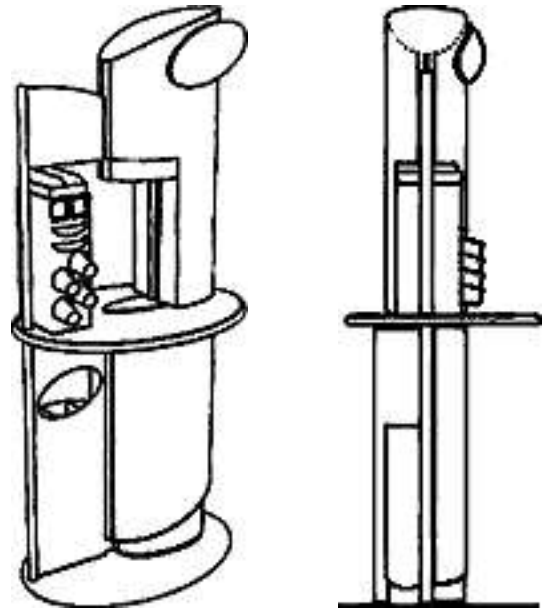

FL56465

**Verlängerungen
Prolongations
Prolongazioni**

117 858 Cl. 09-03 3 design



1235



1237

118 054 Cl. 24-02 1 Design

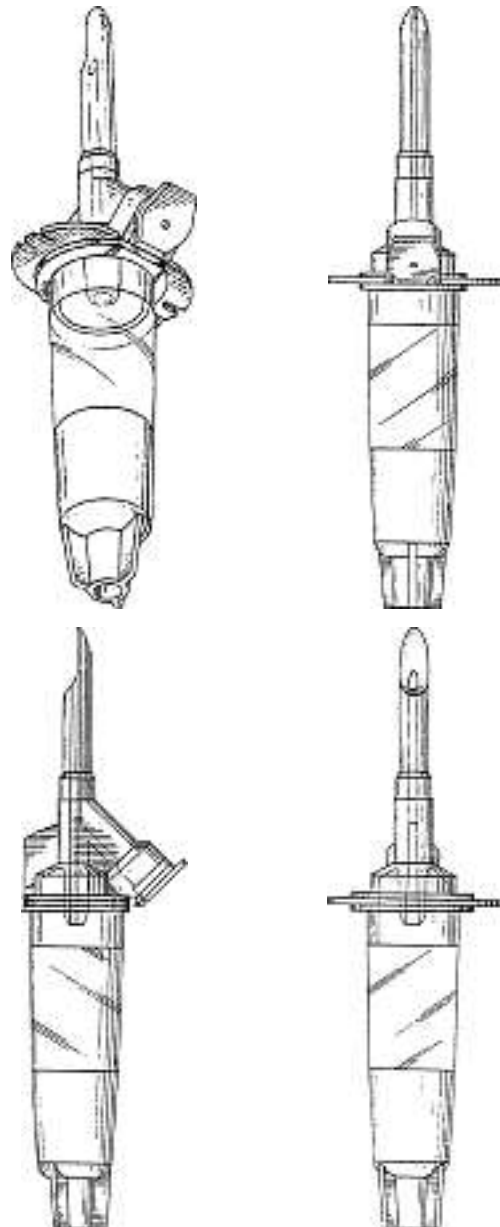

1236

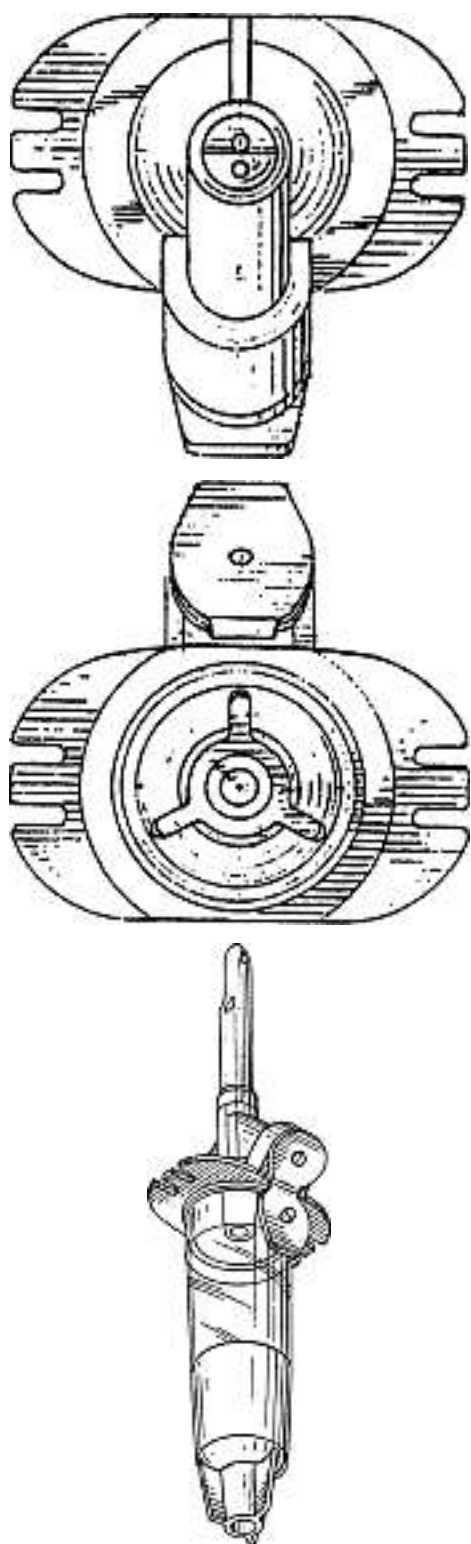

1

118 248 Cl. 21-01 2 Design

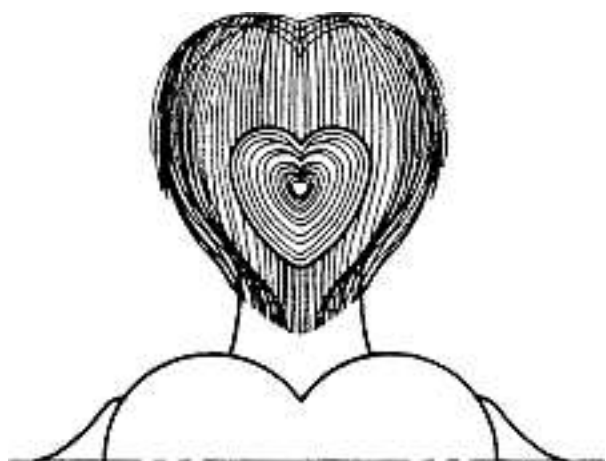
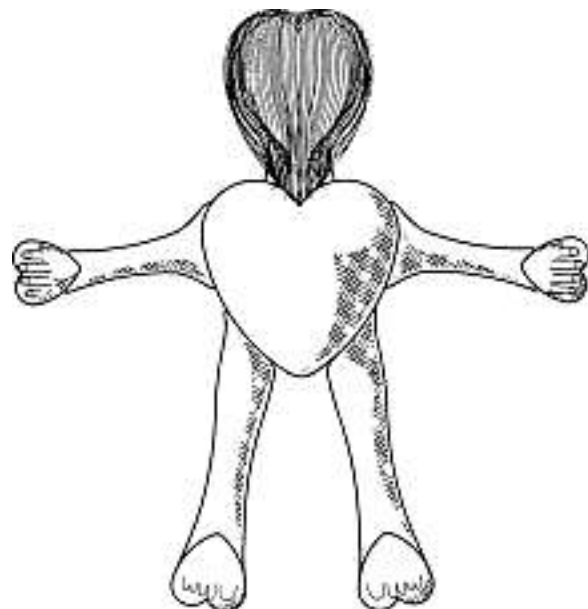
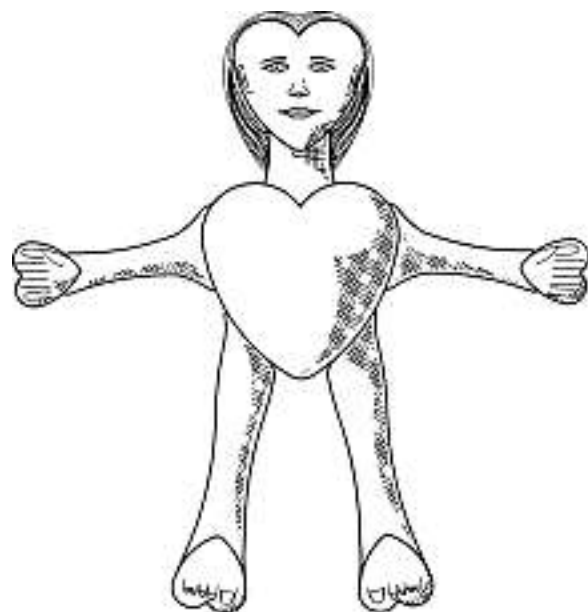



M-2052/90 - 1

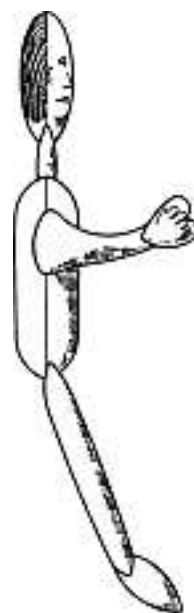
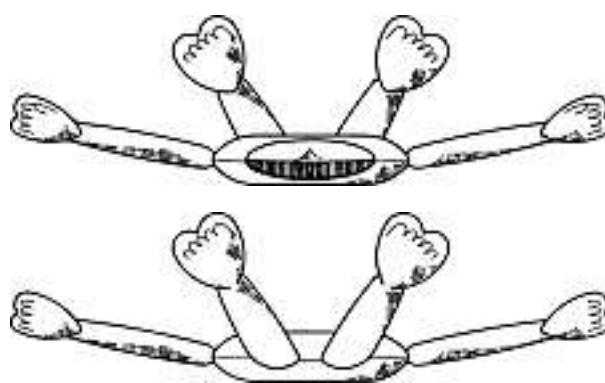
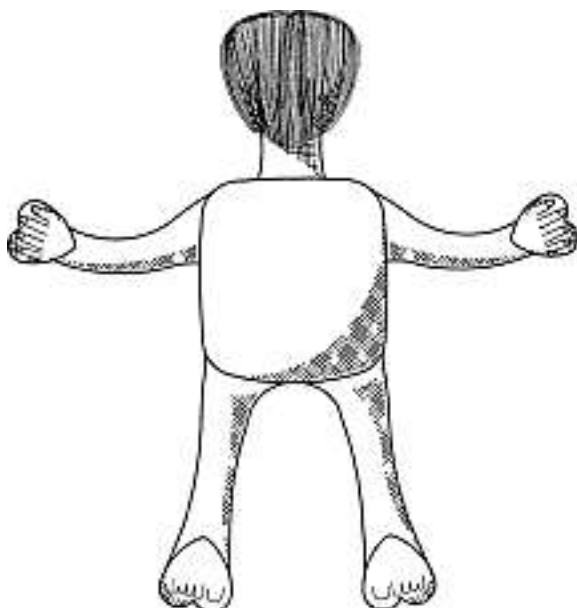
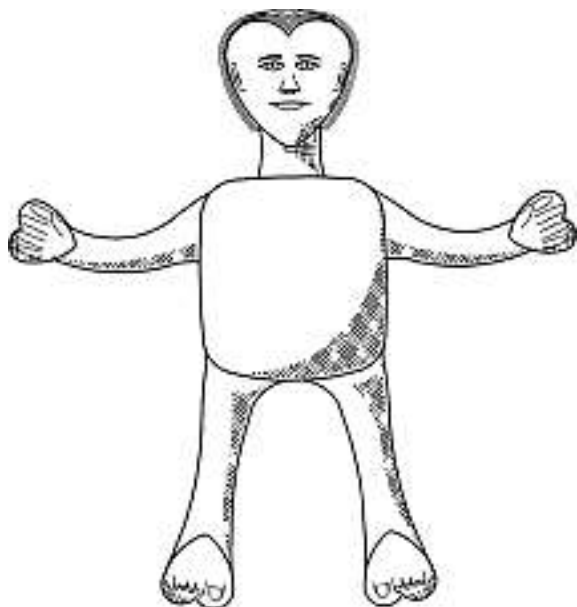

M-2052/90 - 2

122 012	Cl.	21-01	1 design
122 019	Cl.	23-04	2 Design
122 025	Cl.	28-03	1 Design
122 043	Cl.	07-01	1 Design
122 062	Cl.	20-02	1 Design
122 074	Cl.	05-04	1 Design
122 098	Cl.	21-01	1 Design
122 116	Cl.	09-03	1 Design
122 202	Cl.	16-03	13 Design
122 203	Cl.	16-03	15 Design
122 204	Cl.	16-03	1 Design
122 216	Cl.	02-02	1 Design
122 225	Cl.	10-02	1 Design
122 237	Cl.	23-01	1 Design
122 277	Cl.	06-07	2 Design
122 829	Cl.	10-02	7 Design
126 132	Cl.	25-01	2 Design
126 623	Cl.	11-01	1 Design
126 677	Cl.	07-01	1 Design
126 729	Cl.	14-02	2 Design
126 740	Cl.	21-01	1 Design
126 776	Cl.	14-02	1 Design
126 777	Cl.	14-02	1 Design
126 778	Cl.	14-02	1 Design
126 796	Cl.	03-01	4 Design
126 805	Cl.	09-03	1 Design
126 881	Cl.	06-06	5 Design
126 960	Cl.	26-05	2 Design
126 977	Cl.	06-04	1 Design
126 987	Cl.	09-01	1 Design
127 007	Cl.	20-03	17 design

Mutationen
Modifications
Modificazioni

121 129

Übertragung/Namensänderung

Hinterleger: Norden Tubes AB, Box 103, Hjo, SE

Hinterleger: Tec Tubes Sweden AB, Box 103, Hjo, SE

Vertreter: Hepp Wenger Ryffel AG, 9500 Wil SG

131 240

Neuer Vertreter

Vertreter: Lenz & Staehelin, Rechtsanwälte, 8027 Zürich

Löschungen
Radiations
Radiazioni

117 534	Cl.	09-03	1 Design
117 536	Cl.	09-03	1 Design
117 664	Cl.	26-02	1 Design
121 487	Cl.	02-01	1 Design
121 491	Cl.	06-01	1 Design
121 493	Cl.	06-01	1 Design
121 496	Cl.	06-04	1 Design
121 514	Cl.	15-03	1 Design
121 522	Cl.	25-01	2 Design
121 523	Cl.	26-04	8 Design
121 525	Cl.	27-03	1 Design
121 547	Cl.	22-05	1 Design
121 550	Cl.	23-04	1 Design
121 567	Cl.	09-05	2 Design
121 591	Cl.	28-01	3 Design
121 592	Cl.	28-01	1 Design
126 181	Cl.	06-09	1 Design
126 184	Cl.	07-02	1 Design
126 195	Cl.	11-02	1 Design
126 196	Cl.	12-04	1 Design
126 197	Cl.	12-12	1 Design
126 199	Cl.	14-02	1 Design
126 200	Cl.	14-03	1 Design
126 204	Cl.	21-01	1 Design
126 205	Cl.	21-01	1 Design
126 207	Cl.	23-02	1 Design
126 211	Cl.	24-02	1 design
126 214	Cl.	26-03	2 Design
126 215	Cl.	28-03	1 Design
126 217	Cl.	02-05	1 Design
126 224	Cl.	06-03	1 Design
126 244	Cl.	21-01	1 design
126 245	Cl.	22-03	5 design
126 254	Cl.	28-03	1 Design
126 277	Cl.	11-01	30 Design
126 314	Cl.	10-02	12 design

Cl. 08-06

131 279

08.10.2004

1



2



3



4



5



6



7



8





9



13



10



14



11



15



12



16

17



21



18



22



19



23



20



24





25



29



26



30



27



31



28



32

Cl. 09-01 131 281 29.09.2004



M12925/1



M12925/2



M12925/3



M12925/4

Cl. 11-01 131 290 23.12.2004



1

Cl. 19-04 131 296 03.11.2004



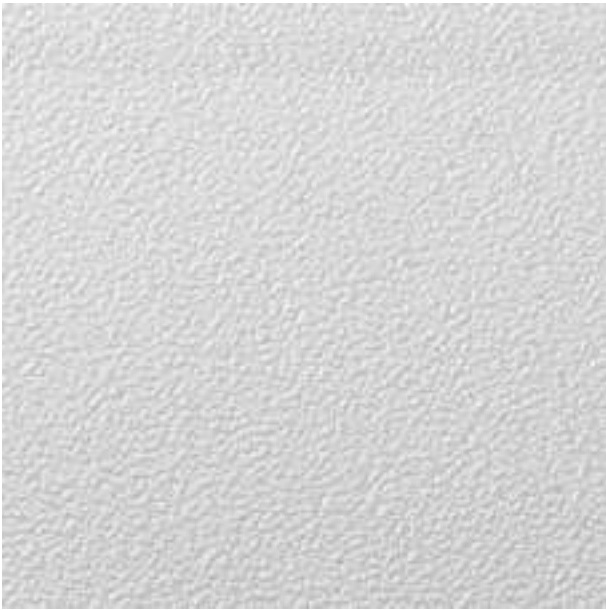

1



2





3



4





5

Cl. 19-08 131 298 29.09.2004



M12934/1



M12934/2



M12934/3

Farbteil 8

Cl. 20-02

131 301

06.01.2005

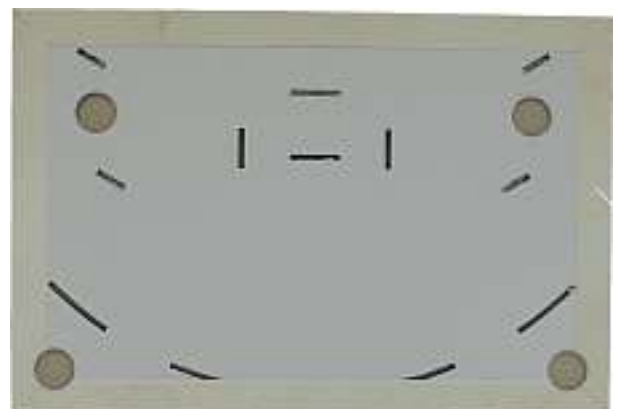



A-2005/1004

Cl. 24-03

131 304

23.12.2004



1







3



4





5

Cl. 25-03

131 307

24.11.2004



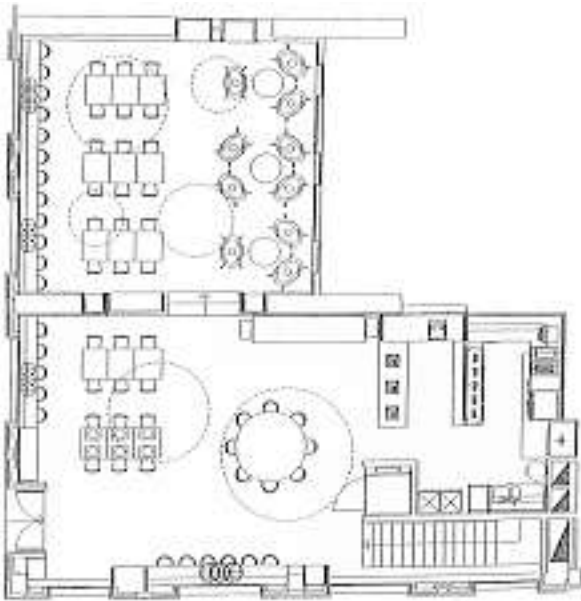

M12959