

## Nationale Hinterlegungen

In der folgenden Liste werden die beim Eidgenössischen Institut für Geistiges Eigentum hinterlegten Designs publiziert. Dabei sind der Reihe nach angegeben:

- internationale Klassenangaben
- Hinterlegungsnummer
- Hinterlegungsdatum
- Allenfalls Aufschub der Veröffentlichung
- Anzahl der hinterlegten Designs
- Bezeichnung
- Name und Wohnsitz des Hinterlegers oder der Hinterlegerin
- gegebenenfalls Name und Wohnsitz des Designers oder der Designerin
- Name und Geschäftssitz des allfälligen Vertreters oder der Vertreterin
- gegebenenfalls Prioritätsangaben
- gegebenenfalls Beschreibungstext
- Ordnungsnummer
- Reproduktion des Designs

## Internationale Hinterlegungen

Die bei der Weltorganisation für geistiges Eigentum in Genf hinterlegten Muster und Modelle mit Benennung Schweiz geniessen den gleichen Schutz wie national hinterlegte Designs. Sie werden jeweils im Blatt «Bulletin des dessins et modèles internationaux» veröffentlicht. Dieses Publikationsorgan ist deshalb für eine vollständige Recherche unbedingt beizuziehen.

## Topographien

Angaben über die vom Eidgenössischen Institut für Geistiges Eigentum eingetragenen Topographien von Halbleitererzeugnissen werden in folgender Anordnung aufgeführt:

- Eintragsnummer
- Anmeldedatum
- Bezeichnung
- Name und Wohnsitz des Anmelders oder der Anmelderin
- gegebenenfalls Name und Wohnsitz des Herstellers oder der Herstellerin
- Name und Geschäftssitz des oder der allfälligen Bevollmächtigten
- Datum und Ort einer allfälligen ersten geschäftlichen Verbreitung der Topographie

## Dépôts nationaux

Les designs déposés à l'Institut Fédéral de la Propriété Intellectuelle sont publiés dans la liste qui suit. Les indications y relatives sont mentionnées dans cet ordre:

- indications des classes internationales
- numéro de dépôt
- date de dépôt
- le cas échéant, ajournement de la publication
- nombre des designs déposés
- désignation
- nom et domicile du/de la déposant/e
- le cas échéant, nom et domicile du/de la designer
- nom et domicile de l'éventuel/le mandataire
- le cas échéant, indication de priorité
- le cas échéant, description du design
- numéro attribué à chaque design
- reproduction du design

## Dépôts internationaux

Les dessins et modèles déposés à l'Organisation Mondiale de la Propriété Intellectuelle à Genève qui désignent la Suisse jouissent de la même protection que les dépôts nationaux. Ils sont chaque fois publiés dans la feuille «Bulletin des dessins et modèles internationaux». Pour une recherche complète, il est indispensable de consulter ledit organe de publication.

## Topographies

Les indications concernant les topographies des produits semi-conducteurs, enregistrées par l'Institut Fédéral de la Propriété Intellectuelle, sont énumérées dans l'ordre suivant:

- numéro d'enregistrement
- date de dépôt
- désignation
- nom et domicile du/de la déposant/e
- le cas échéant, nom et domicile du/de la producteur/trice
- nom et domicile de l'éventuel/le mandataire
- date et lieu d'une éventuelle première mise en circulation de la topographie

## Depositi nazionali

Nella lista seguente vengono pubblicati i design depositati presso l'Istituto Federale della Proprietà Intellettuale. Sono menzionati nel seguente ordine:

- indicazioni delle classi internazionali
- numero di deposito
- data del deposito
- se del caso, indicazione che la pubblicazione è stata differita
- numero dei design depositati
- designazione
- nome e domicilio del depositante
- se del caso, nome e domicilio del designer
- nome e sede di un eventuale mandataro
- se del caso, indicazioni di priorità
- se del caso, descrizione del design
- numero d'ordine
- riproduzione del design

## Depositi internazionali

I disegni e modelli depositati presso l'Organizzazione Mondiale della Proprietà Intellettuale a Ginevra con denominazione Svizzera godono della medesima protezione del deposito nazionale. Essi vengono pubblicati ogni volta nel foglio «Bulletin des dessins et modèles internationaux». Quest'organo di pubblicazione è da consultare se si vuole effettuare una ricerca completa.

## Topografie

Le indicazioni concernenti le topografie di prodotti a semiconduttori depositati presso l'Istituto Federale della Proprietà Intellettuale sono menzionate nell'ordine seguente:

- numero di registrazione
- data del deposito
- designazione
- nome e domicilio del/la richiedente
- se del caso, nome e domicilio del/la produttore/trice
- nome e sede di un eventuale mandataro
- data e luogo di un'eventuale prima messa in circolazione della topografia

**Hinterlegungen  
Dépôts  
Deposit**

Cl. 20-02 129 944 16.09.2003  
 1 design – nuancier de pigmentation  
 Déposant: Galderma S.A., Zugerstrasse 8, 6330 Cham  
 Designer: Susan Taylor, New York  
 Priorité: FR, 21.03.2003  
 Fin de la période ajournement de la publication

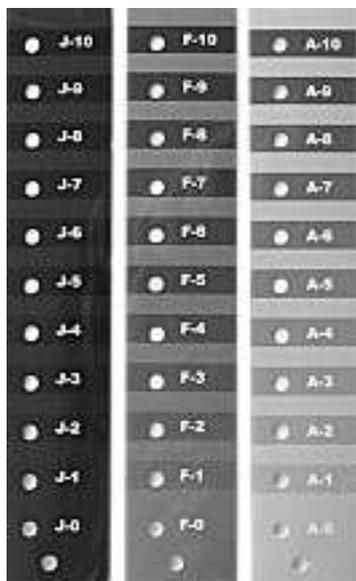

D1/CH

Cl. 01-01 132 027 26.07.2005  
 1 Design – Lebensmittel  
 Hinterleger: Mars, Incorporated, A Delaware Corporation,  
 6885 Elm Street, McLean/VA, US  
 Designer: Michel Flambeau, Steinbourg; Claudine Benfodda,  
 Steinbourg  
 Vertreter: A.W. Metz & Co. AG, 8024 Zürich  
 Priorität: EM, 28.06.2005

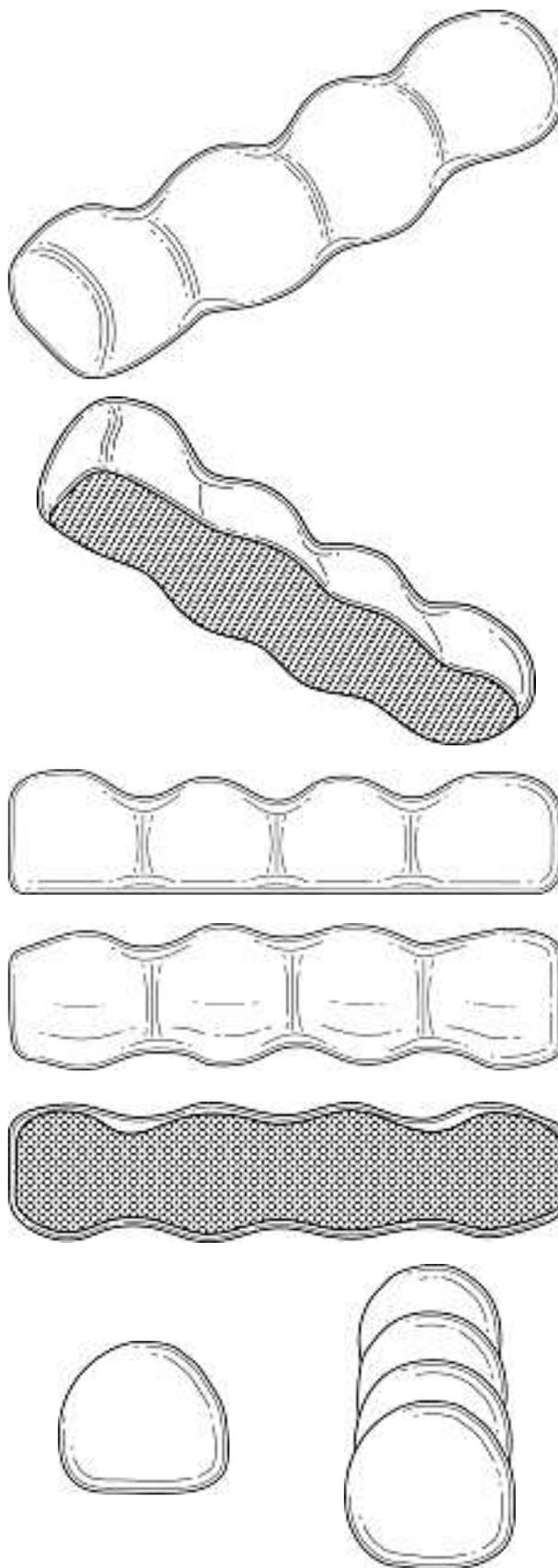

50896-CH-1-DN

Cl. 02-07 132 028 21.07.2005  
 1 Design – Gurt  
 Hinterleger: Ernst Thoma, Paradiesstrasse 28,  
 9404 Rorschacherberg

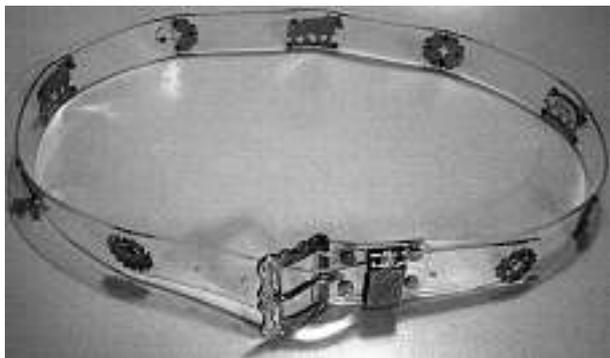
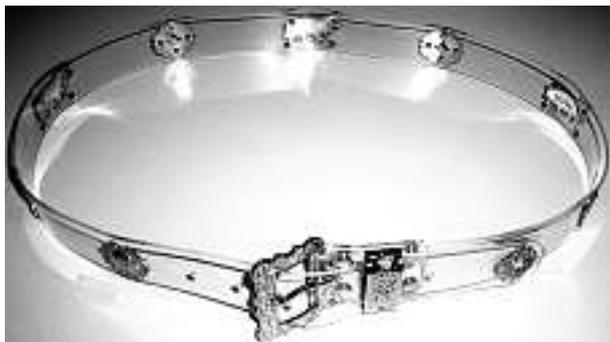

ETRO Transparentgürtel

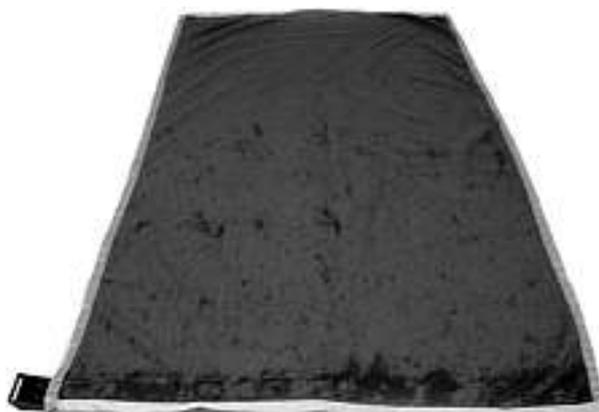

1

Cl. 03-01 132 029 12.07.2005

14 Design – Taschen und Zubehör

Hinterleger: Roy Grosser, Weggengasse 2, 8001 Zürich

Beschreibung des Designs: Tasche, bestehend aus einem faltbaren Material, das mit einem Tragriemen zum Umhängen versehen ist. Dieser erstreckt sich am Rand entlang des faltbaren Materials. Und ist, zwar nicht sichtbar, zusätzlich versteift. Und kann in seiner Position verkürzt oder verlängert werden. Durch das Ausbreiten des Material ist eine Liegefläche erzeugbar, die bedarfsweise wieder als Tasche faltbar ist.

Zusätzlich angebrachte boxenförmige sowie auch netzartig Behältnisse dienen der Aufbewahrung von flachen sowie auch tiefen Gegenständen; wie zum Beispiel eines Buch oder Fussballs. Die Proportion als Tasche, kann je nach Inhalte und Behältnisse, im eigenen Ermessen angepasst und ergänzt werden.





2



5

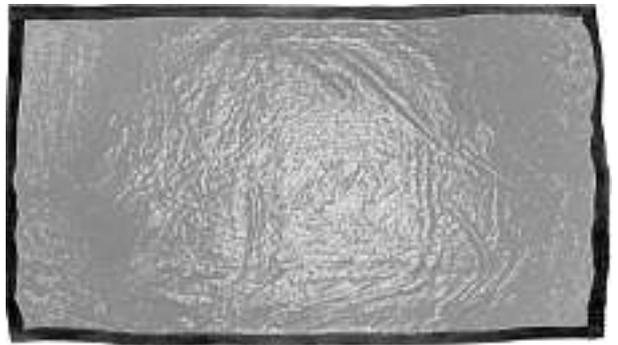

3



4

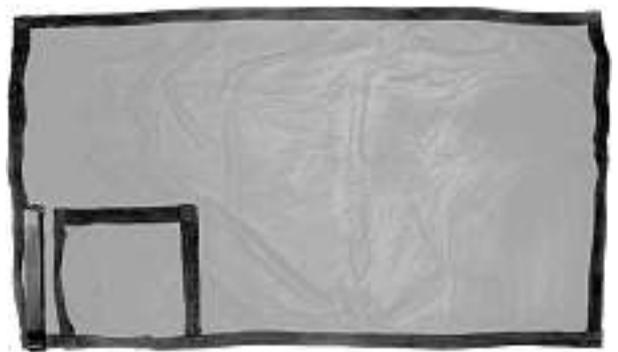



6



7



8



9



10



11





12



13



14

Cl. 03-01

132 030

12.07.2005

1 Design – Tasche

Hinterleger: Roy Grosser, Weggengasse 2, 8001 Zürich  
 Beschreibung des Designs: Tasche, bestehend aus einem faltbaren und saugfähigen Material. Durch das Ausbreiten bzw. Auseinanderfalten der Tasche ist eine Liegefläche erzeugbar, und bedarfsweise wieder als Tasche faltbar.

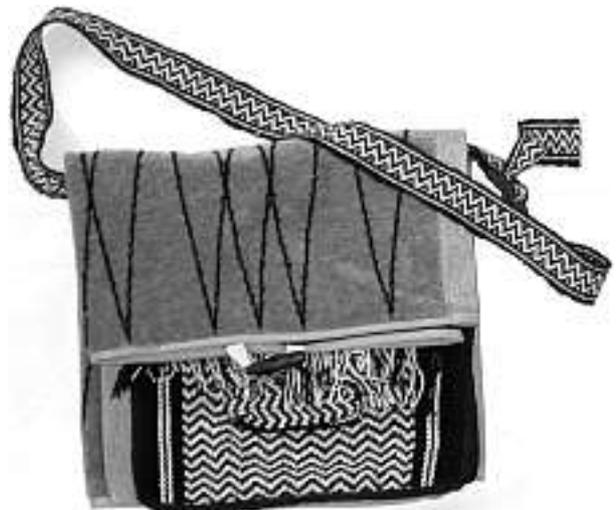

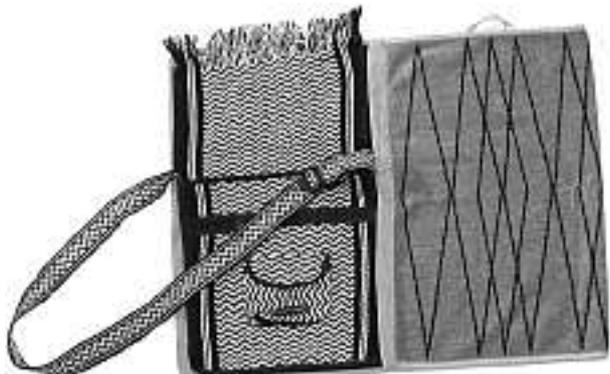
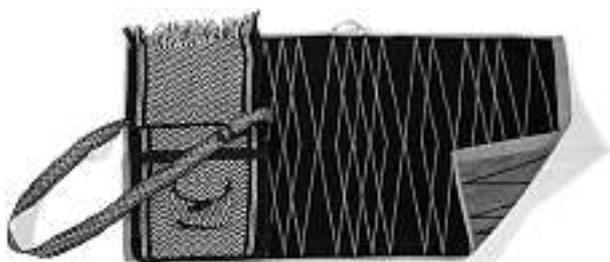

Safari

Cl. 03-03 **132 031** 15.07.2005

1 Design – Sonnenschirm

Hinterleger: Ernst Doppler & Co. GmbH, Schlosstrasse 24,  
5280 Braunau-Ranshofen, AT

Designer: Herbert Forthuber, Simbach

Vertreter: Patentanwaltsbüro Dr. Urs Falk, 6312 Steinhausen

Beschreibung des Designs: Sonnenschirm mit mehreren  
Schirmsegmenten, von denen eines silberfarben eingefärbt  
ist. Die übrigen Segmente (die hier grau dargestellt sind)  
haben eine beliebige andere Farbe.



1

Cl. 05-05 **132 032** 20.07.2005

8 Design – Gewebe (Textilien)

Hinterleger: Sonntex Freizeitprodukte GmbH,

Industriestrasse 20, Melsungen, DE

Designer: Elfriede Meyer, Pommelsbrunn

Vertreter: Bovard AG, 3000 Bern 25

Priorität: EM, 21.01.2005

1 (siehe Farbteil Heftmitte)

2 (siehe Farbteil Heftmitte)

3 (siehe Farbteil Heftmitte)

4 (siehe Farbteil Heftmitte)

5 (siehe Farbteil Heftmitte)

6 (siehe Farbteil Heftmitte)

7 (siehe Farbteil Heftmitte)

8 (siehe Farbteil Heftmitte)

Cl. 05-05 **132 033** 20.07.2005

3 Design – Gewebe (Textilien)

Hinterleger: Sonntex Freizeitprodukte GmbH,

Industriestrasse 20, Melsungen, DE

Designer: Doris Zwingelberg, Nürnberg

Vertreter: Bovard AG, 3000 Bern 25

Priorität: EM, 02.02.2005

1 (siehe Farbteil Heftmitte)

2 (siehe Farbteil Heftmitte)

3 (siehe Farbteil Heftmitte)

Cl. 05-05 **132 034** 24.08.2005

1 Design – Gewebe (Textilien)

Hinterleger: Sonntex Freizeitprodukte GmbH,

Industriestrasse 20, Melsungen, DE

Designer: Elfriede Meyer, Pommelsbrunn

Vertreter: Bovard AG, 3000 Bern 25

Priorität: EM, 17.03.2005

300493 (siehe Farbteil Heftmitte)

Cl. 06-01 **132 035** 15.07.2005

1 Design – Stuhl

Hinterleger: Möbelfabrik Seon AG, Aarauerstrasse 4,

5703 Seon; Lavidia GmbH, Bruckstrasse 18-20,

Schramberg-Waldmössingen, DE

Designer: Norbert Beck, Markdorf

Vertreter: Möbelfabrik Seon AG, 5703 Seon



Helena

Cl. 06-04                      **132 036**                      11.07.2005  
 1 Design – CD-Ablage  
 Hinterleger: Josef Hutter, Säntisstrasse 16, 9435 Heerbrugg



metall-X

Cl. 06-04                      **132 037**                      30.07.2005  
 2 Design – Regal, Sideboard  
 Hinterleger: Josef Hutter, Säntisstrasse 16, 9435 Heerbrugg





1

2

Cl. 07-01 **132 038** 11.07.2005  
18 Design – Becher, Tassen, Untertassen, Kännchen  
Hinterleger: Erste Bayreuther Porzellanfabrik Walküre  
Siegmond Meyer GmbH, Gravenreuther Strasse 5,  
Bayreuth, DE  
Designer: Daniel Eltner, Erlangen  
Vertreter: Schürmann & Partner, 8001 Zürich



1

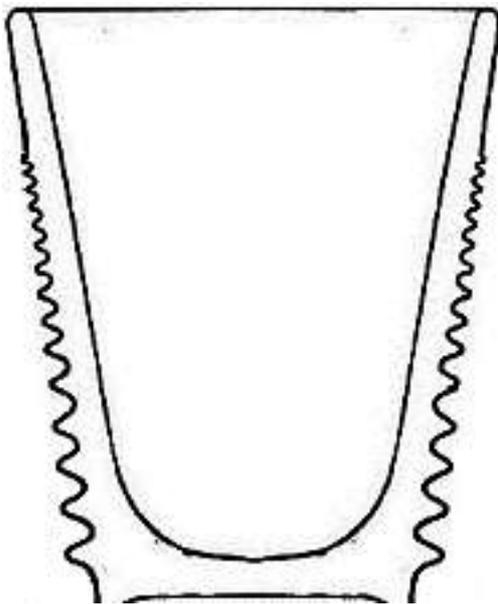

2

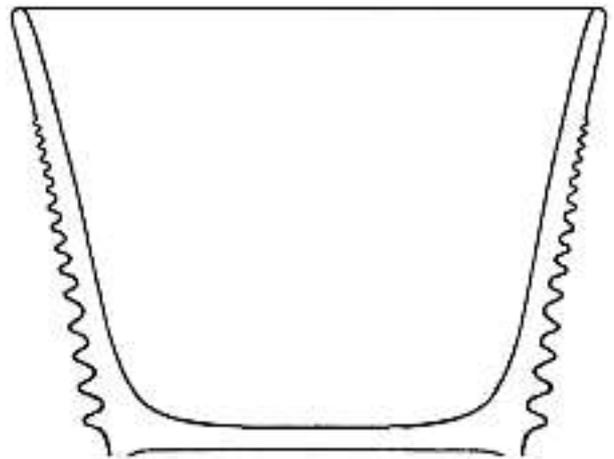

3





4



5



6



7



8



9



11

12

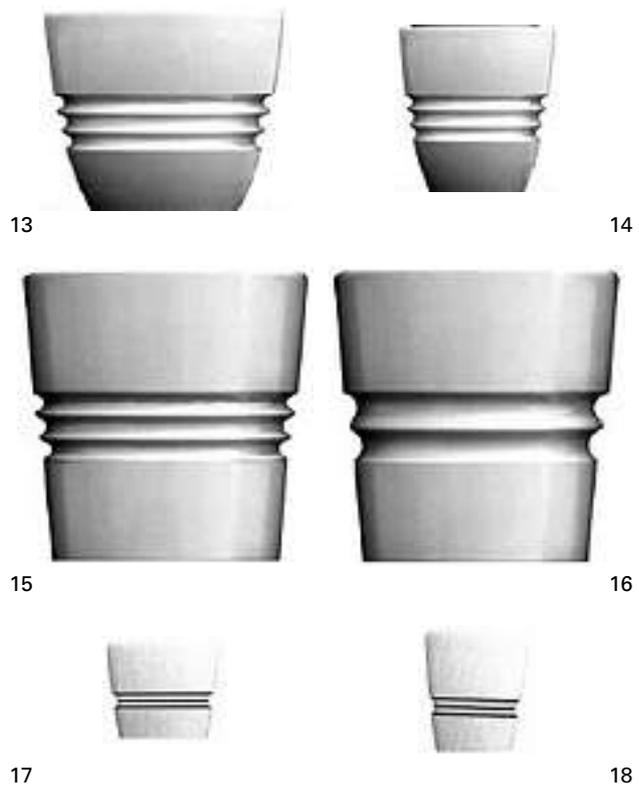

Cl. 07-01                      **132 039**                      22.07.2005  
 2 Design – Deckel  
 Hinterleger: Dart Industries Inc., 14901 S. Orange Blossom  
 Trail, Orlando / FL, US  
 Designer: Douglas M. Laib, Orlando  
 Vertreter: A. Braun, Braun, Héritier, Eschmann AG,  
 Patentanwälte, 4051 Basel  
 Priorität: US, 18.02.2005

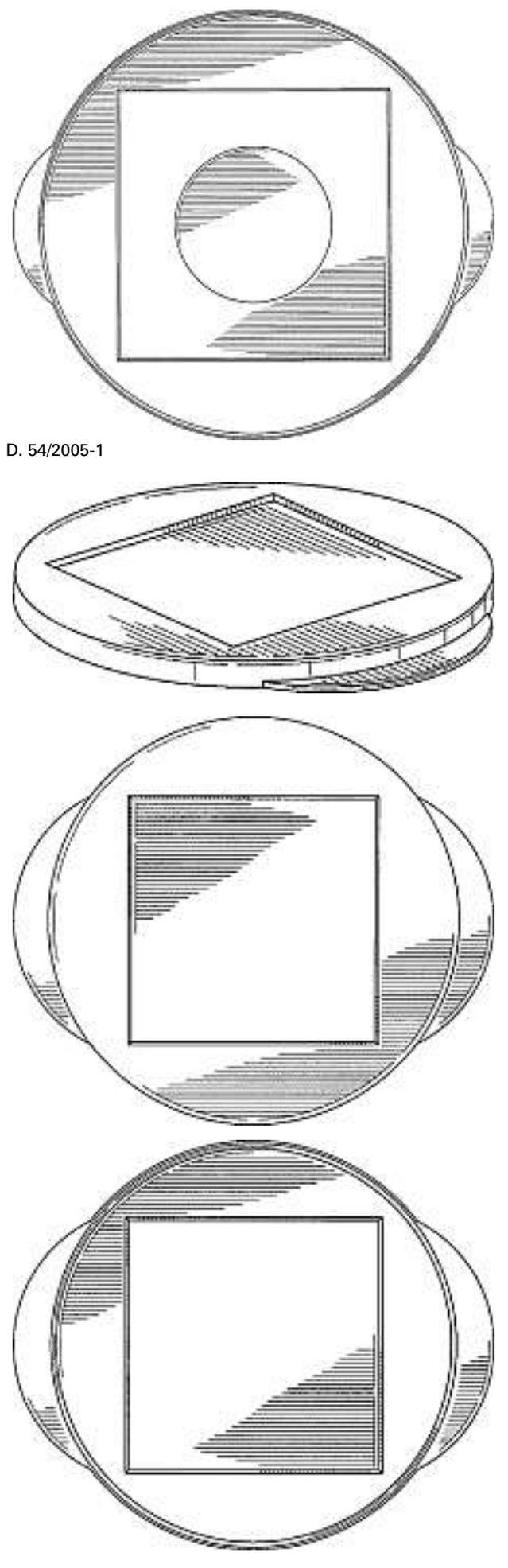
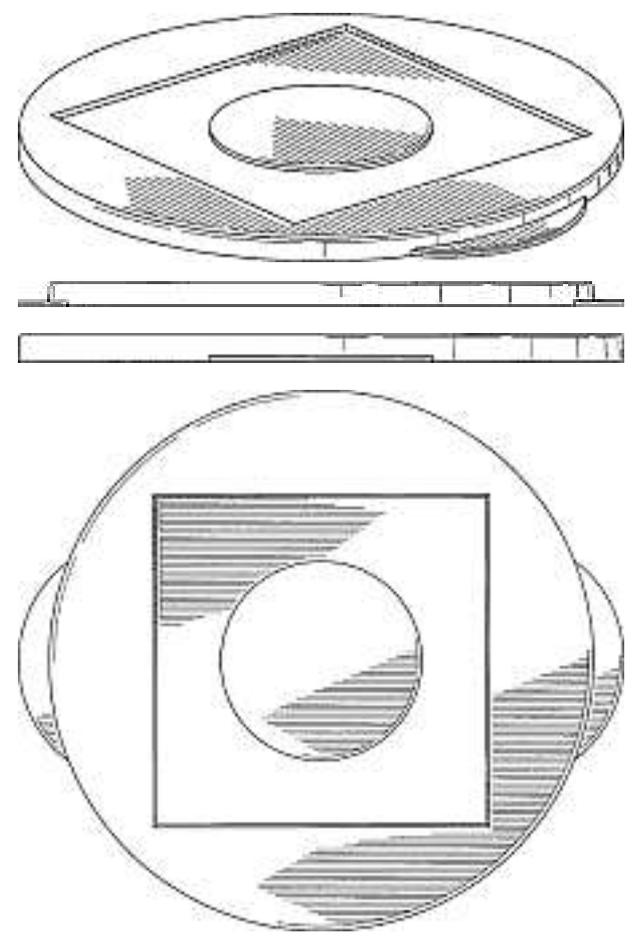

D. 54/2005-1



D. 54/2005-2

Cl. 07-01 132 040 22.07.2005

2 Design – Schüssel

Hinterleger: Dart Industries Inc., 14901 S. Orange Blossom Trail, Orlando / FL, US

Designer: Douglas M. Laib, Orlando; Anita Suk Ping Liu, Orlando

Vertreter: A. Braun, Braun, Héritier, Eschmann AG, Patentanwälte, 4051 Basel

Priorität: US, 18.02.2005

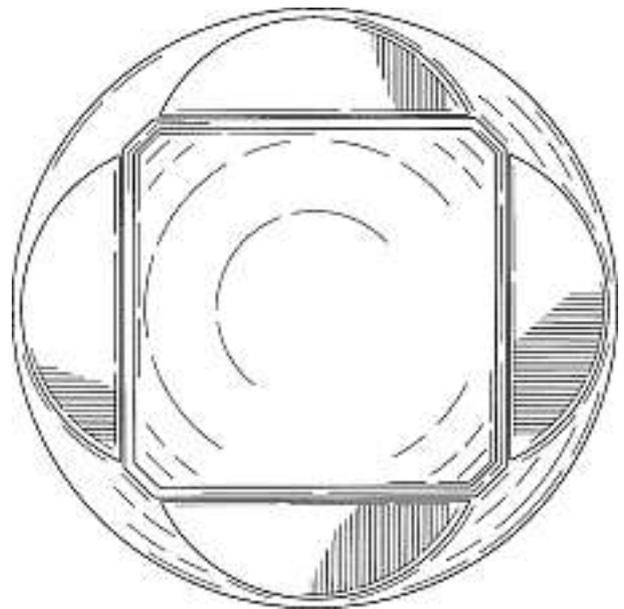
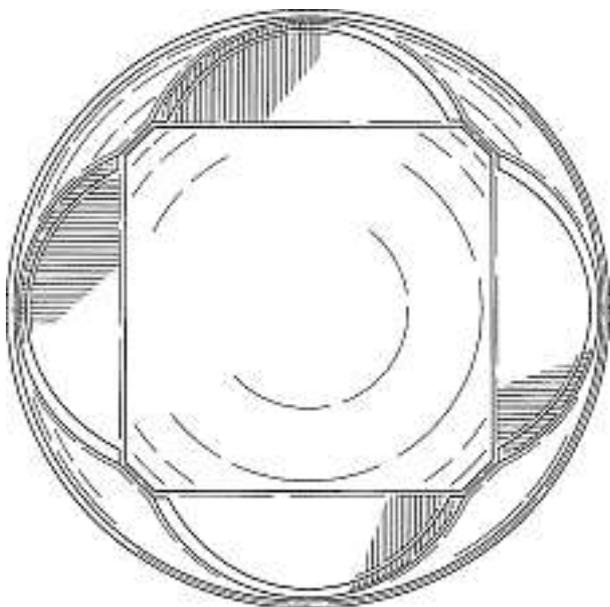
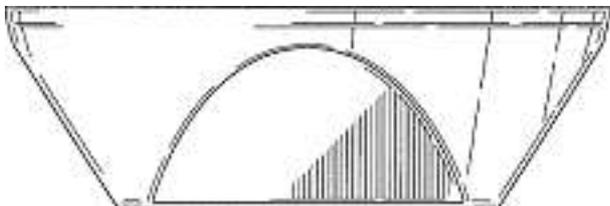
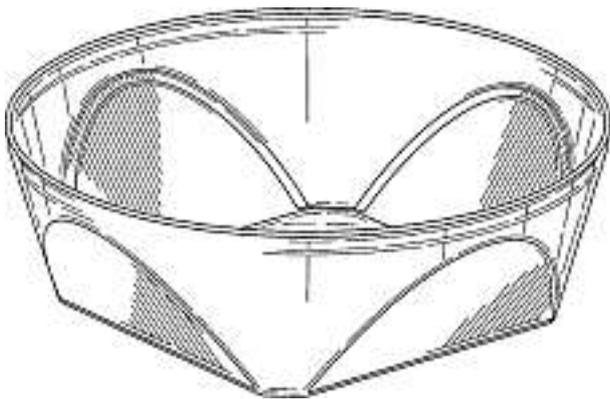

D. 55/2005-1

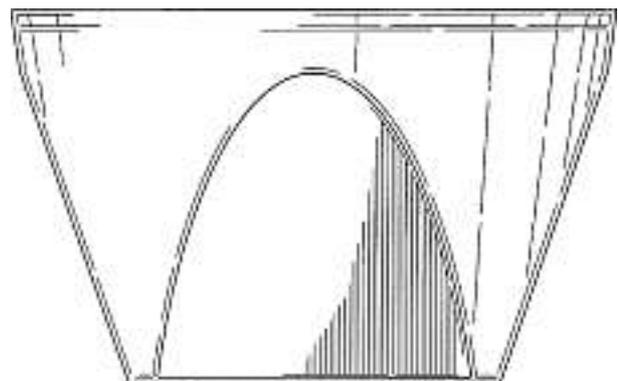
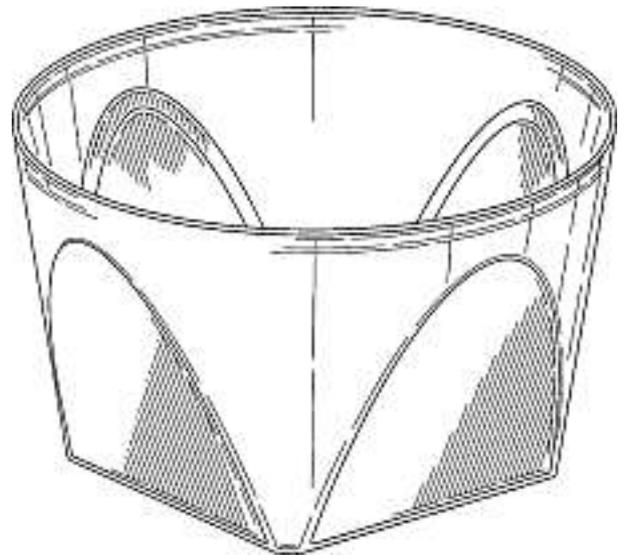

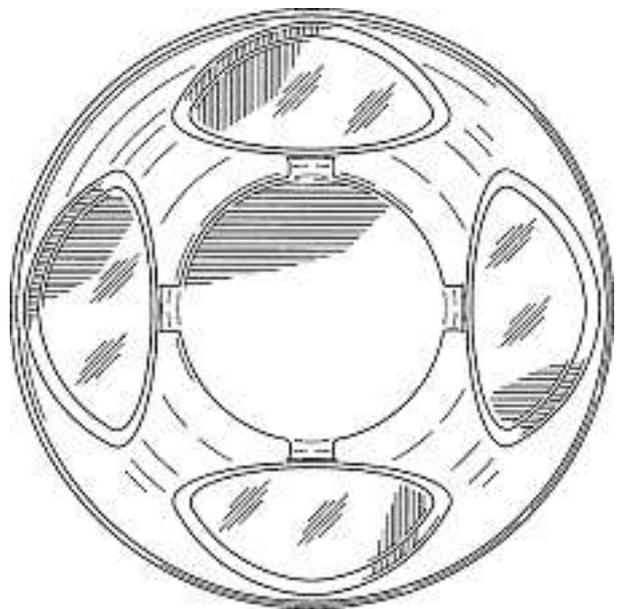
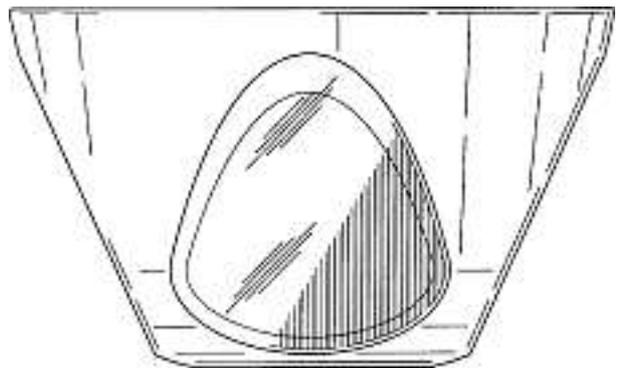
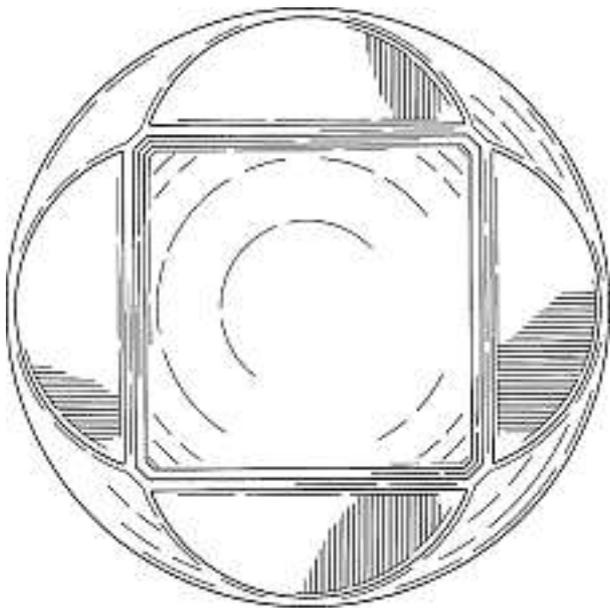
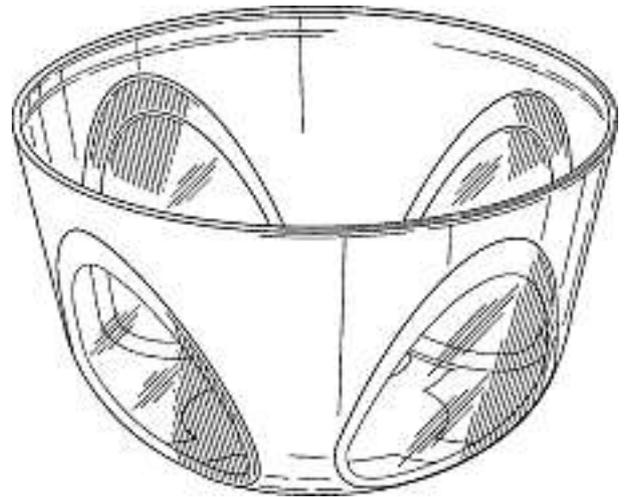
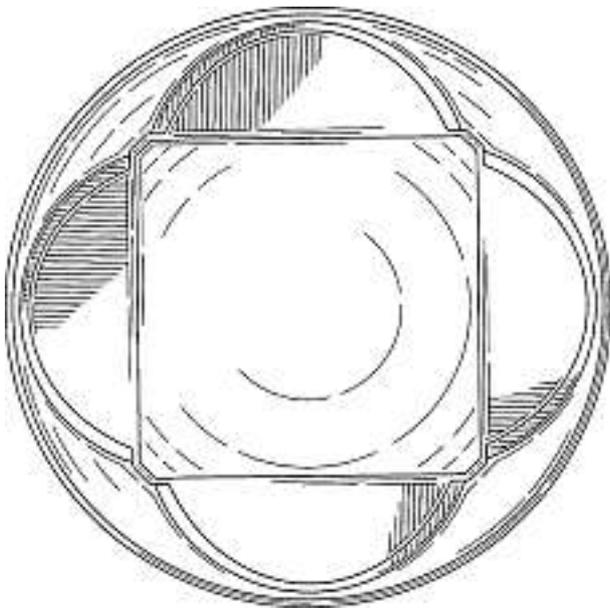

D. 55/2005-2

Cl. 07-01                      **132 041**                      22.07.2005  
 2 Design – Schüssel  
 Hinterleger: Dart Industries Inc., 14901 S. Orange Blossom  
 Trail, Orlando / FL, US  
 Designer: Douglas M. Laib, Orlando; Anita Suk Ping Liu,  
 Orlando  
 Vertreter: A. Braun, Braun, Héritier, Eschmann AG,  
 Patentanwälte, 4051 Basel  
 Priorität: US, 18.02.2005



Cl. 07-04 132 043 15.07.2005  
 1 Design – Soda-Bereiter  
 Hinterleger: Soda-Club Ltd., Gilboa Street, Airport City,  
 P. O. Box 28, Ben Gurion Airport, IL  
 Designer: Michael Anthony Thomson, Peterborough;  
 Frank Anthony Pateman, Peterborough  
 Vertreter: Hepp Wenger Ryffel AG, 9500 Wil SG

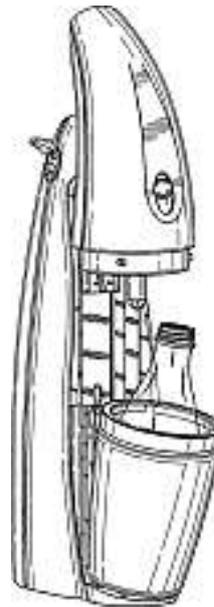
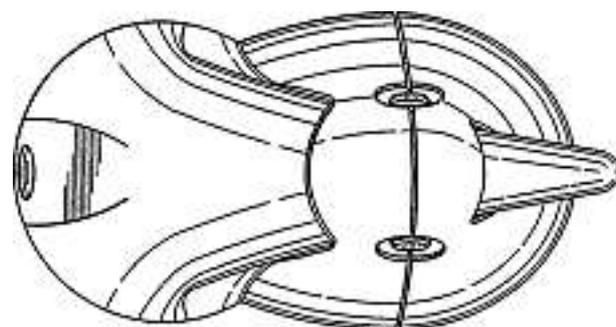
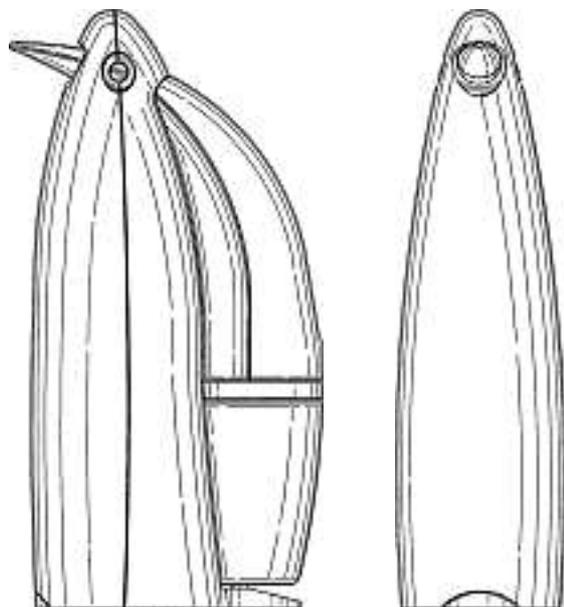
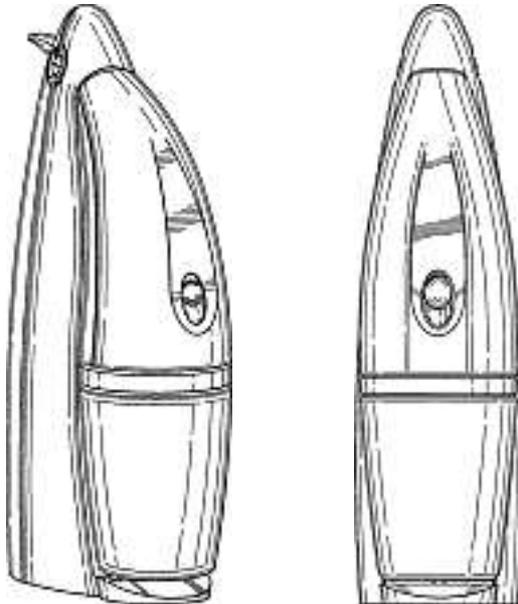

MSOD002CH

Cl. 07-05 132 044 11.08.2005  
 1 Design – Zubehör für Reinigungsgeräte  
 Hinterleger: Avet AG, Eichwiesstrasse 9, 8630 Rüti ZH  
 Designer: Roland Sacks, Bubikon  
 Vertreter: Hans Rudolf Gachnang, 8501 Frauenfeld  
 Priorität: EM, 01.03.2005





1

Cl. 07-06                      **132 045**                      05.08.2005  
 2 Design – Salz-/Pfeffer-Mühlen  
 Hinterleger: PI-DESIGN AG, Kantonsstrasse 100,  
 6234 Triengen  
 Designer: Jorgen Bodum, St. Niklausen  
 Vertreter: Isler & Pedrazzini AG, 8023 Zürich  
 Priorität: DK, 10.02.2005



1



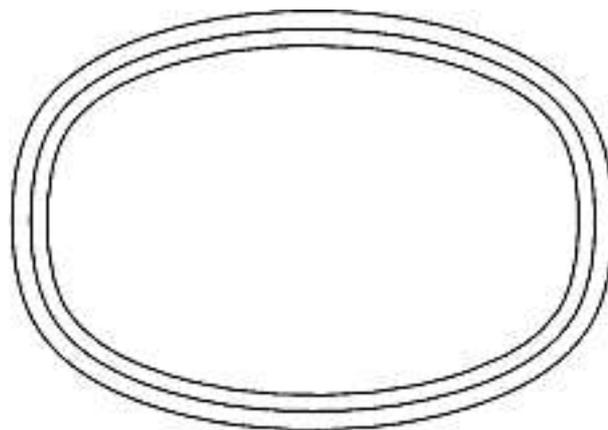
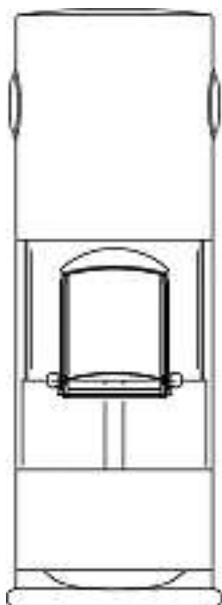
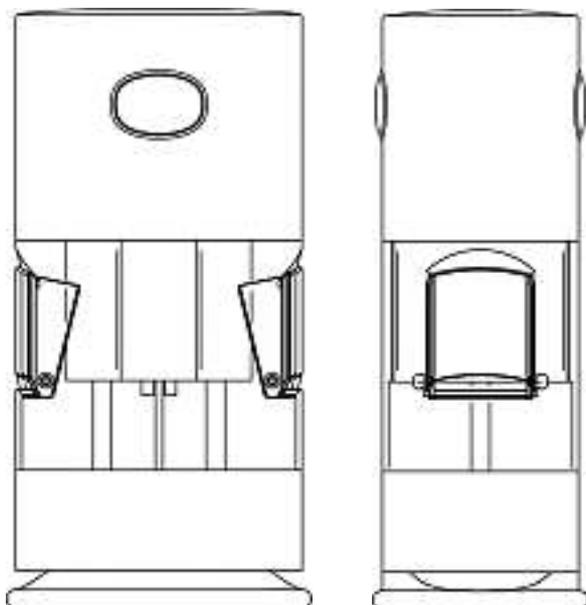
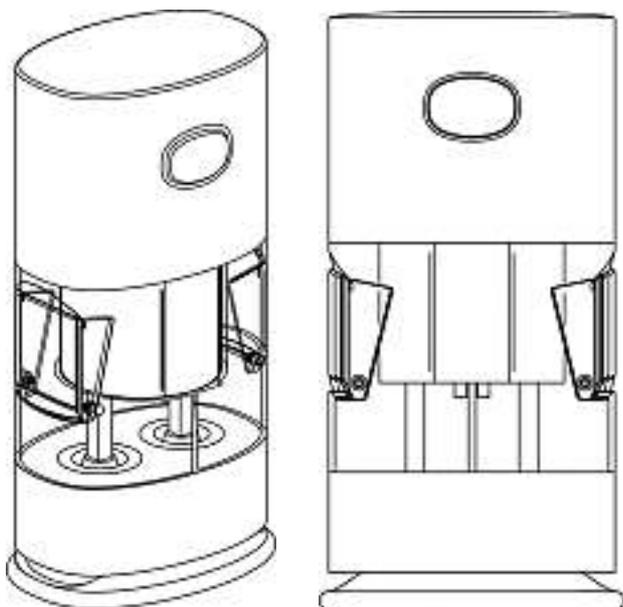

2

Cl. 07-99 **132 046** 11.07.2005  
 1 design – support pour papier ménage  
 Déposant: Cécile Lauper-Weick, 57, chem. Cannelet,  
 1285 Athenaz (Avusy)



iBiToP

Cl. 08-04 **132 047** 08.07.2005  
 11 Design – Schraubendrehereinsätze  
 Hinterleger: PB Baumann GmbH, Bahnhofstrasse 24,  
 3457 Wasen im Emmental  
 Designer: Max Baumann, Burgdorf  
 Vertreter: Bovard AG, 3000 Bern 25  
 1 (siehe Farbteil Heftmitte)  
 2 (siehe Farbteil Heftmitte)  
 3 (siehe Farbteil Heftmitte)  
 4 (siehe Farbteil Heftmitte)  
 5 (siehe Farbteil Heftmitte)  
 6 (siehe Farbteil Heftmitte)  
 7 (siehe Farbteil Heftmitte)  
 8 (siehe Farbteil Heftmitte)  
 9 (siehe Farbteil Heftmitte)  
 10 (siehe Farbteil Heftmitte)  
 11 (siehe Farbteil Heftmitte)

Cl. 08-08 **132 048** 19.07.2005  
 1 Design – Bolzen  
 Hinterleger: fischerwerke Artur Fischer GmbH & Co. KG,  
 Weinhalde 14-18, 72178 Waldachtal, DE  
 Designer: Marc Schäffer, Horb  
 Vertreter: Patentanwälte, Schaad, Balass, Menzl & Partner AG,  
 8034 Zürich  
 Priorität: DE, 01.03.2005



1

Cl. 08-08 **132 049** 19.07.2005  
 7 Design – Befestigungs-, Halte- und Montagemittel  
 Hinterleger: fischerwerke Artur Fischer GmbH & Co. KG,  
 Weinhalde 14-18, 72178 Waldachtal, DE  
 Designer: Oliver Hacker, Horb; Martin Linka, Horb  
 Vertreter: Patentanwälte Schaad, Balass, Menzl & Partner AG,  
 8034 Zürich  
 Priorität: DE, 17.03.2005

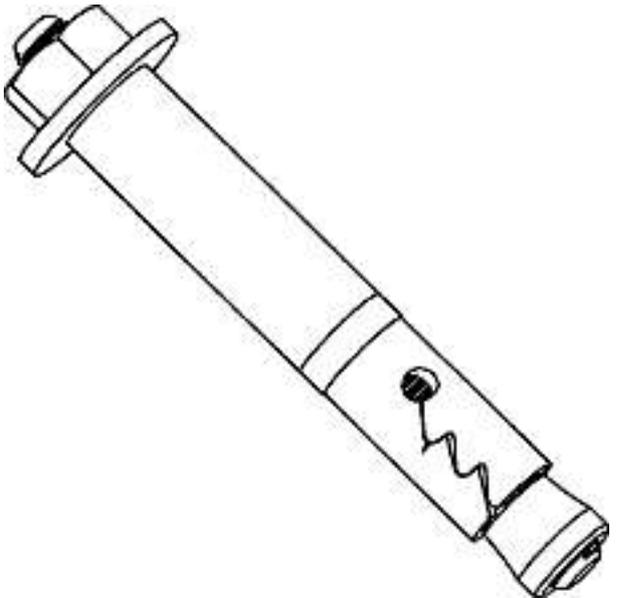

1

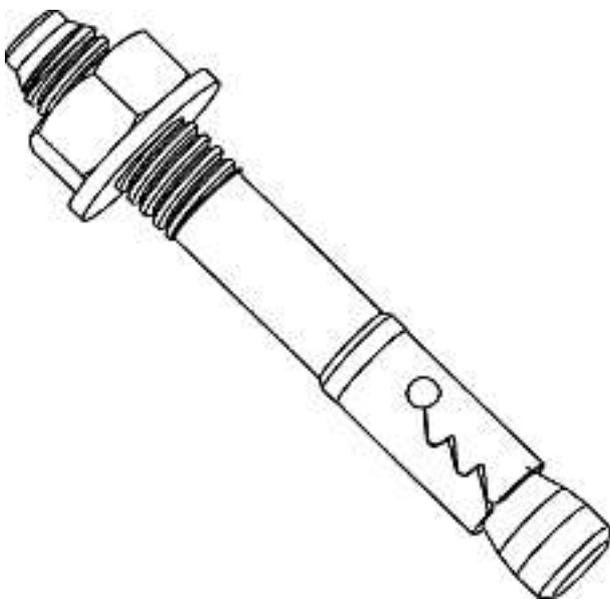

2



3

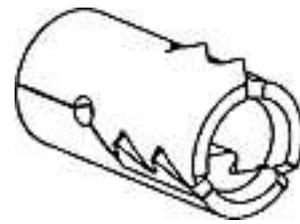

4

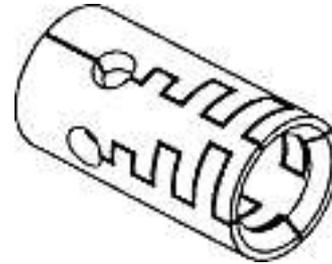

5



6

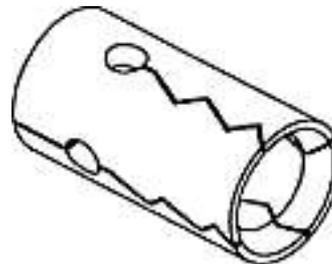

7

Cl. 08-08 **132 050** 27.07.2005  
 1 Design – Tuchhalter  
 Hinterleger: FD Formfabrik AG, Alte Affolterstrasse 1,  
 8909 Zwillikon  
 Designer: Dominic Spiess, Zürich; Marco Braun, Cham





001 Tuchhalter «SEA-STAR»

Cl. 09-01 132 051 15.07.2005

2 Design – Flasche

Hinterleger: Soda-Club Ltd., Gilboa Street, Airport City,  
P. O. Box 28, Ben Gurion Airport, IL

Designer: Frank Anthony Pateman, Peterborough; Jennifer  
Claire Roff, St. Noets

Vertreter: Hepp Wenger Ryffel AG, 9500 Wil SG

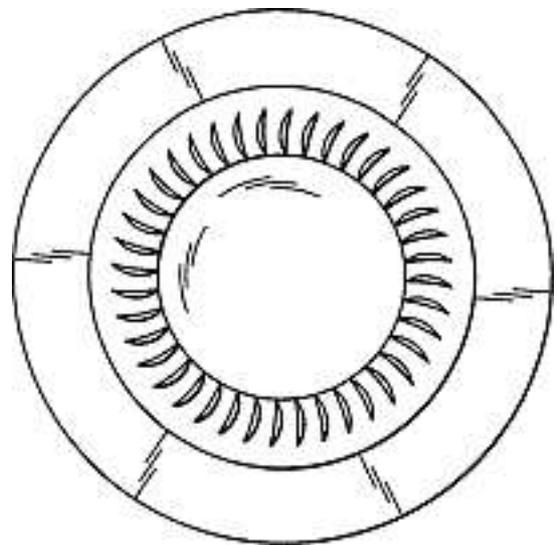
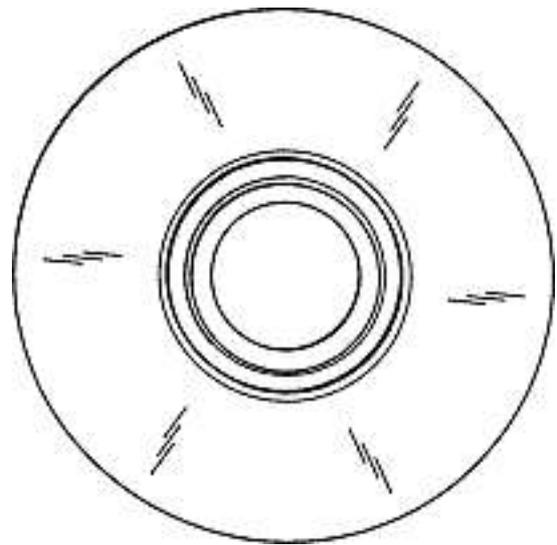

MSOD003CH/1



MSOD003CH/2

Cl. 09-01 132 052 22.07.2005

1 Design – Flasche

Hinterleger: William Sigrist, Grindel, 6315 Oberägeri

Vertreter: OK pat AG, 6300 Zug  
S36-0002D-CH (siehe Farbteil Heftmitte)

Cl. 09-01 132 053 29.07.2005  
 8 Design - Flaschen  
 Hinterleger: ASB Grünland Helmut Aurenz GmbH,  
 Porschestrasse 4, 71634 Ludwigsburg, DE  
 Designer: Claudia Schmidt, Murr; Jürgen Strohacker,  
 Heilbronn  
 Vertreter: Isler & Pedrazzini AG, 8023 Zürich  
 Priorität: EM, 02.03.2005

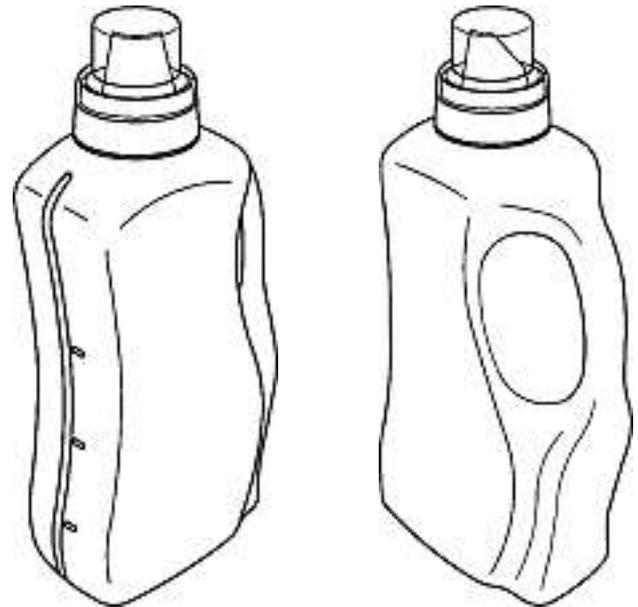
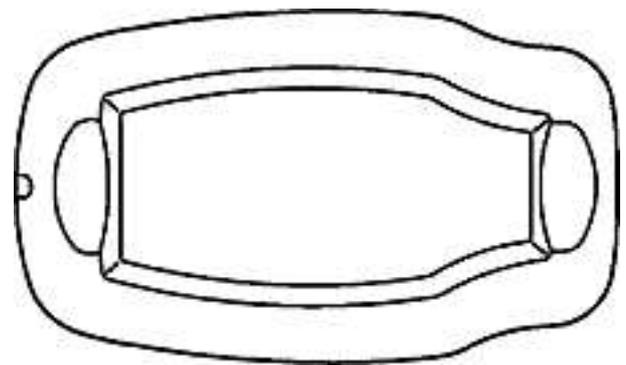
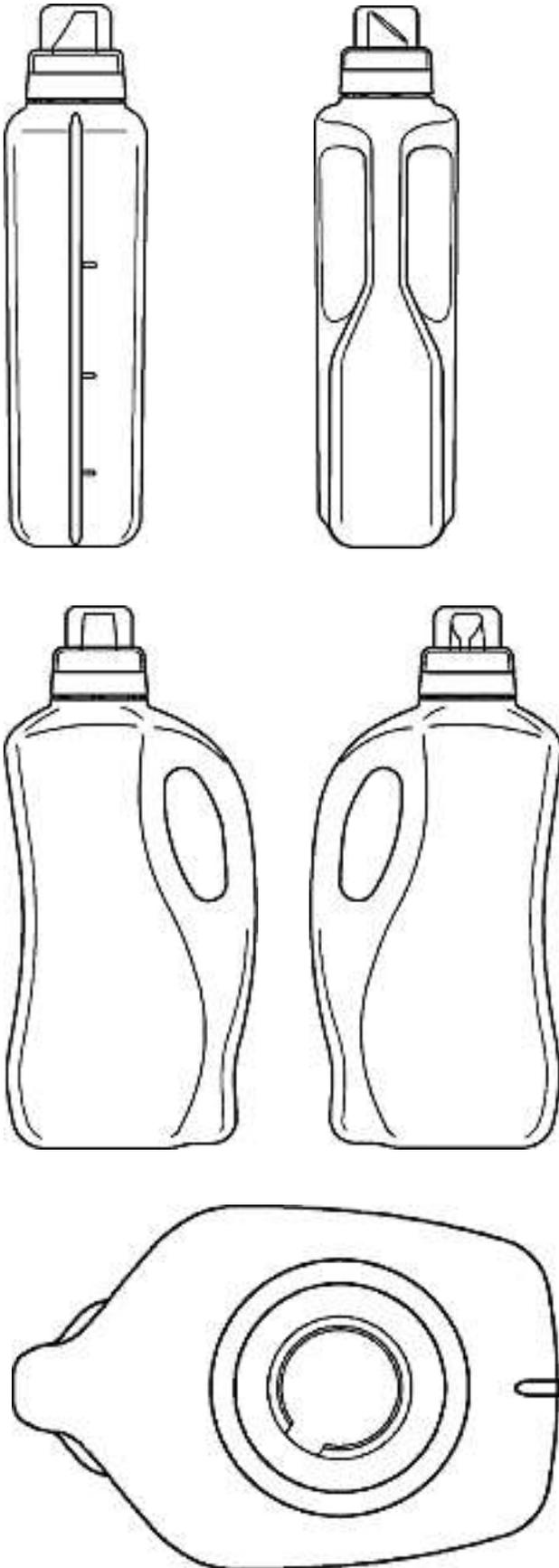

1

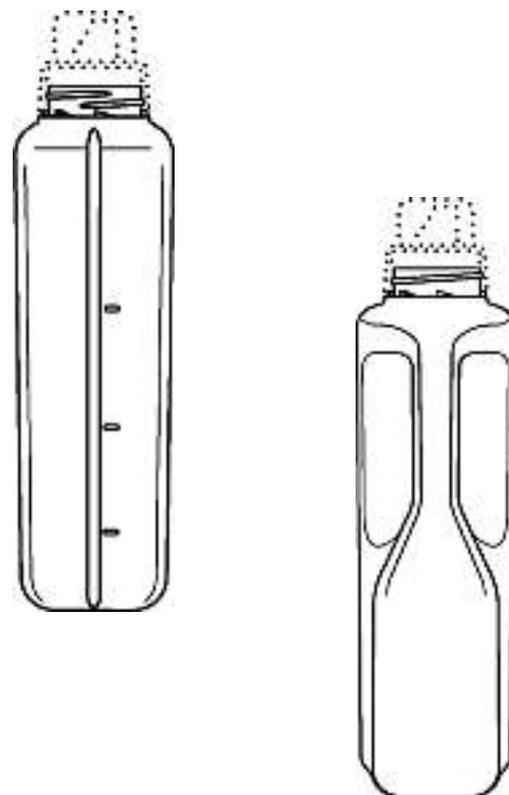



2

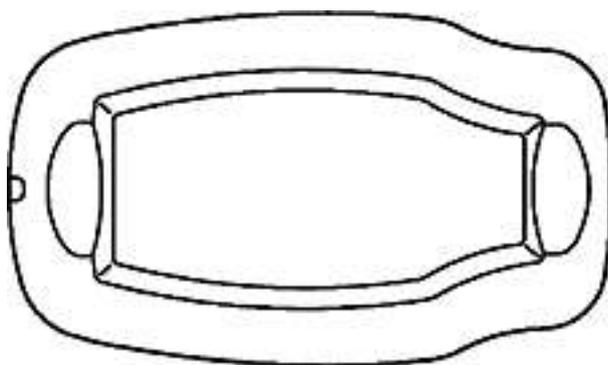
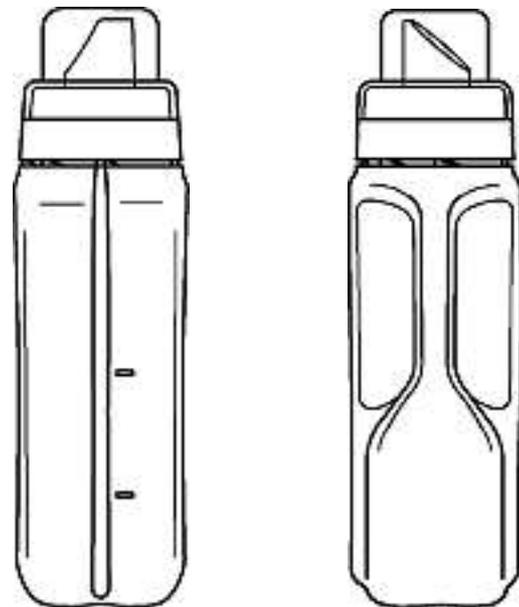
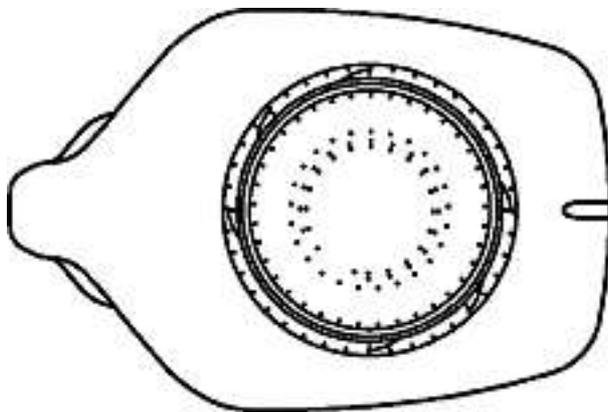

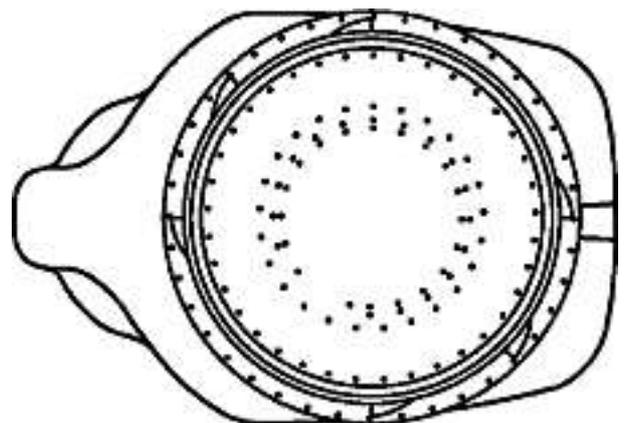
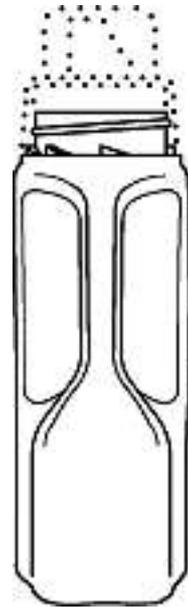
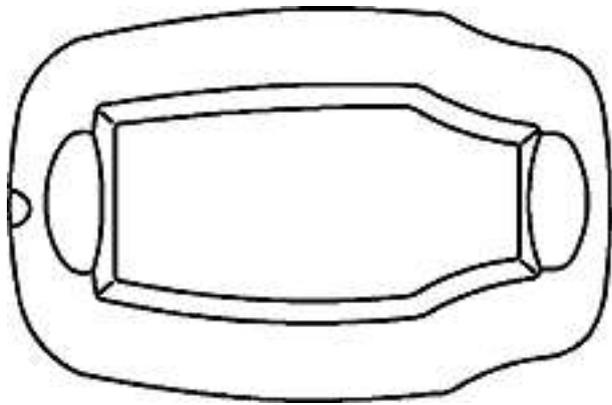
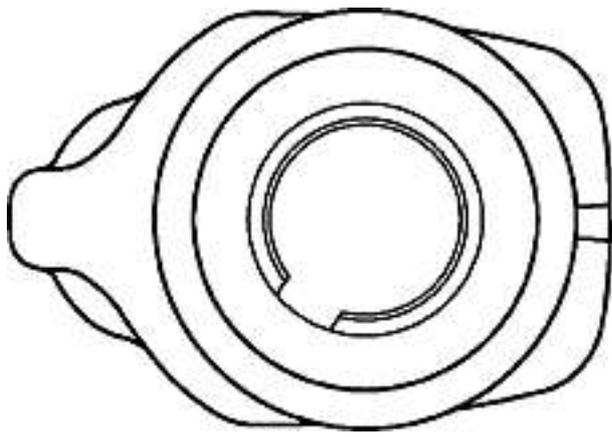

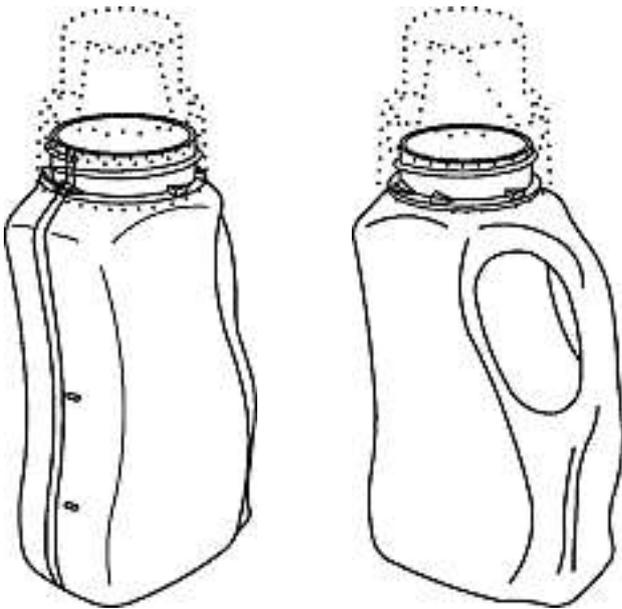
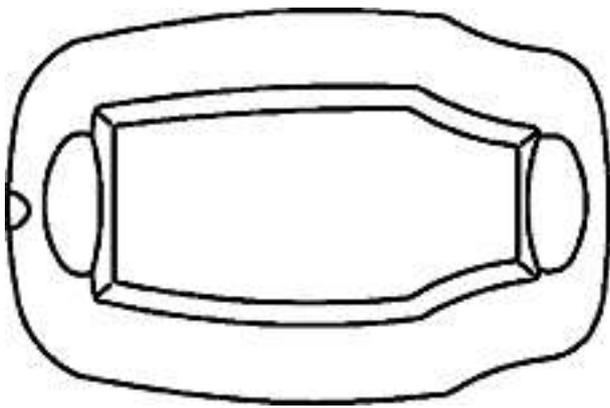

4





5





6

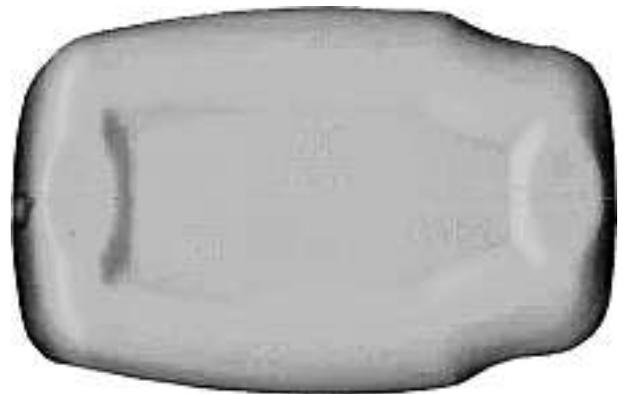

7

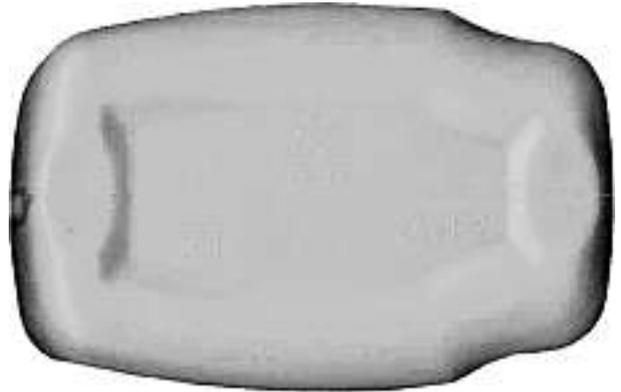

Cl. 09-01 132 054 09.08.2005  
1 Design – Flasche  
Hinterleger: Migros-Genossenschafts-Bund,  
Limmatstrasse 152, 8005 Zürich  
Designer: Daniel Ladstätter, Wernberg



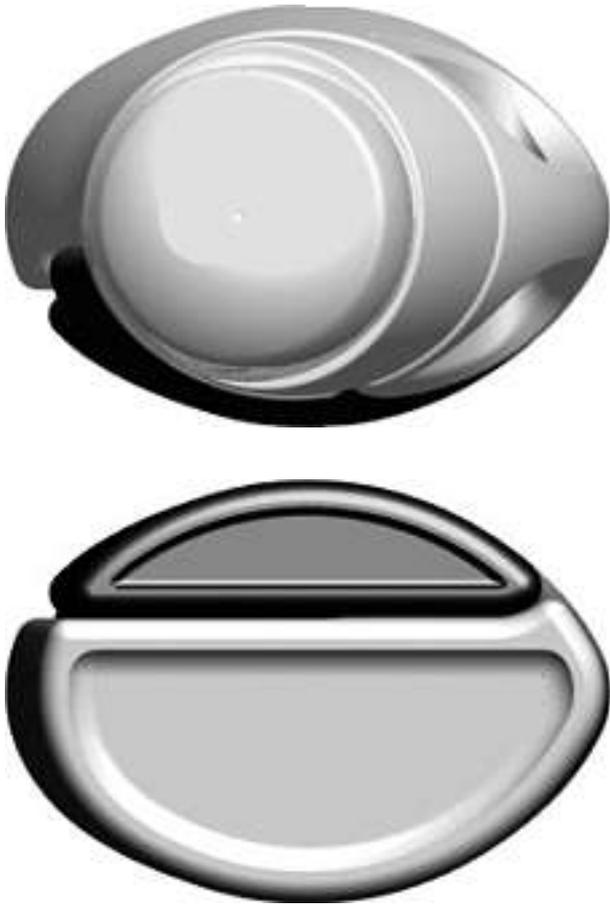

TOTAL - Zweikammerflasche

Cl. 09-03                      **132 055**                      22.07.2005  
 2 design – boîte de rangement portable  
 Déposant: Sony Computer Entertainment Inc., 2-6-21,  
 Minami-Aoyama, Minato-ku, Tokyo, JP  
 Designer: Ken Kutaragi, Tokyo  
 Mandataire: Micheli & Cie, 1226 Thônex (Genève)  
 Priorité: JP, 15.04.2005

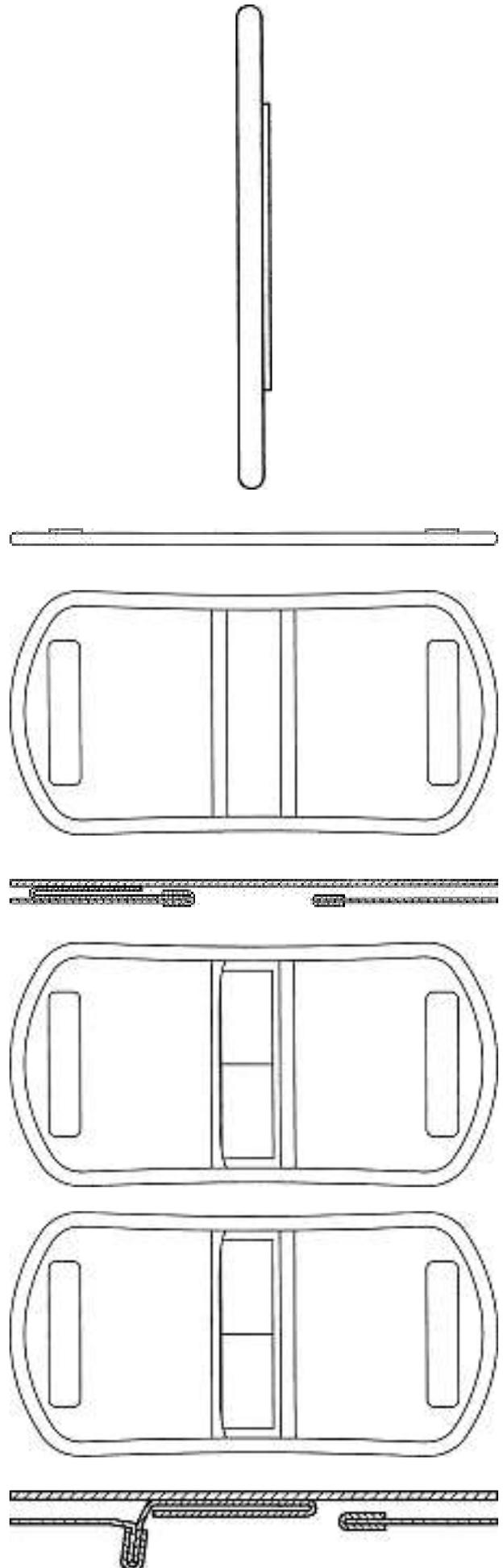
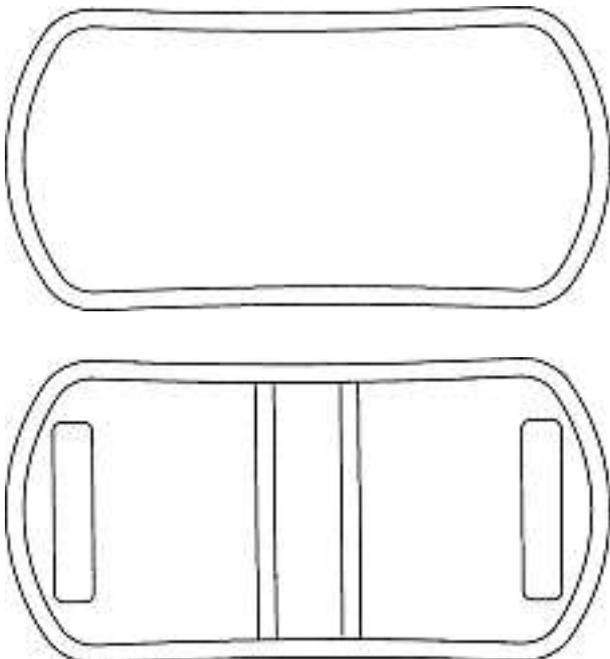

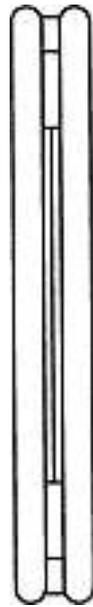
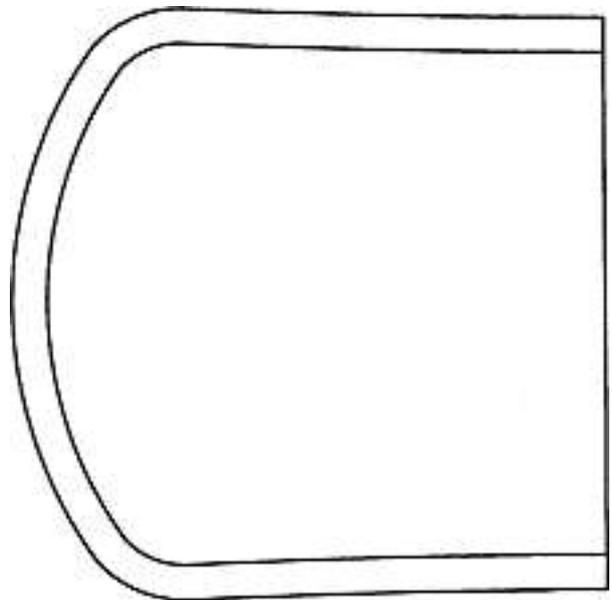
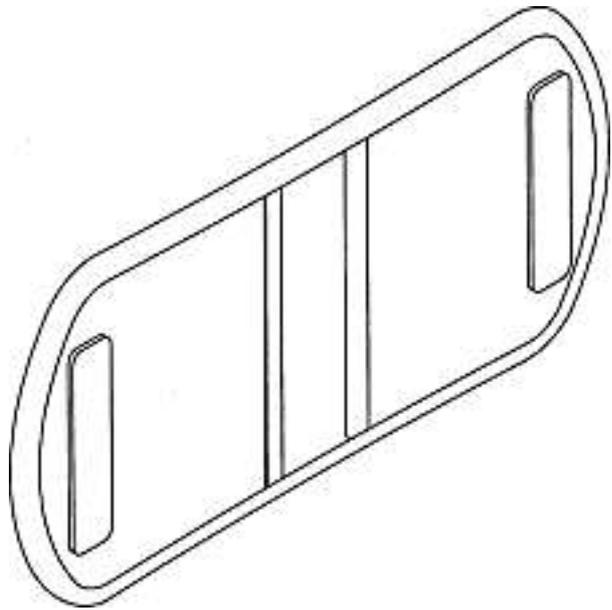
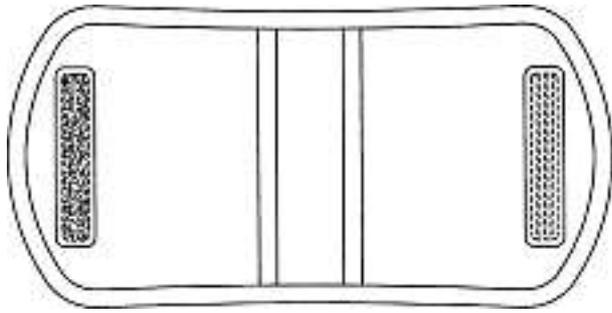

14519/1

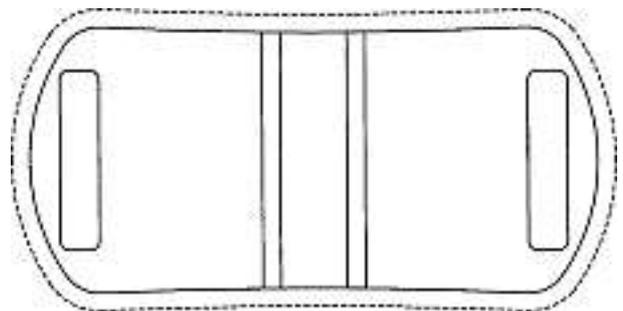

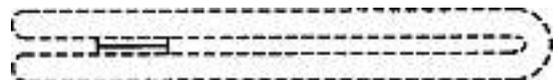
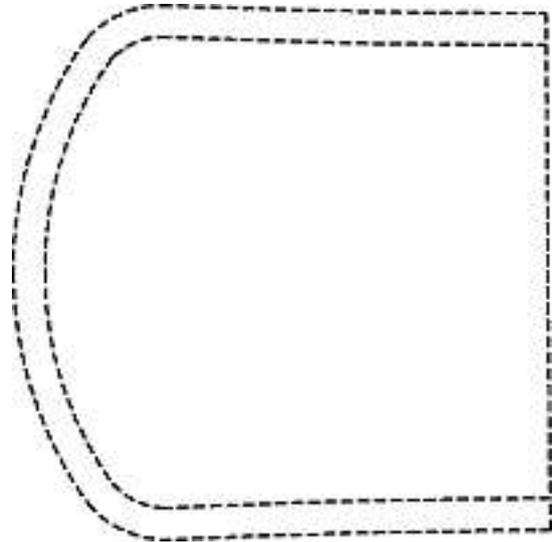
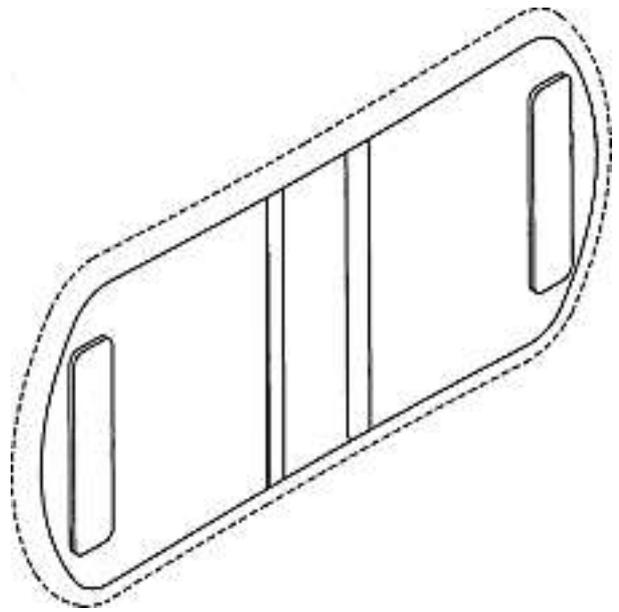
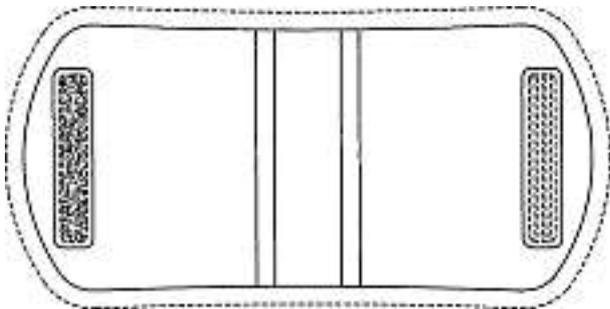
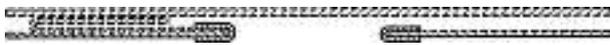
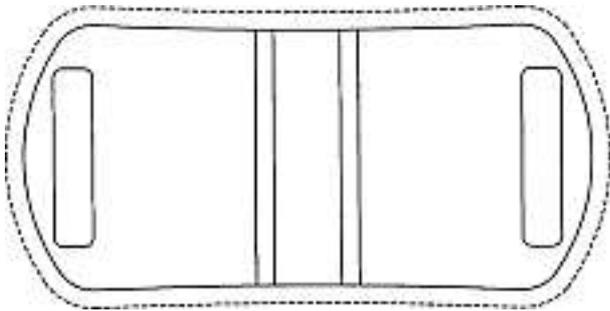

14519/2

Cl. 10-05 **132 057** 23.08.2005  
 13 Design – Steuergerät für  
 Sprühbeschichtungs-  
 vorrichtungen  
 Hinterleger: ITW Gema AG, Mövenstrasse 17, 9015 St. Gallen  
 Designer: Felix Mauchle, Abtwil; Christian Marxer, Mauren  
 Vertreter: E. Blum & Co., 8044 Zürich  
 Priorität: DE, 25.02.2005  
 A-2005/1028a (siehe Farbteil Heftmitte)  
 A-2005/1028b (siehe Farbteil Heftmitte)  
 A-2005/1028c (siehe Farbteil Heftmitte)  
 A-2005/1028d (siehe Farbteil Heftmitte)  
 A-2005/1028e (siehe Farbteil Heftmitte)  
 A-2005/1028f (siehe Farbteil Heftmitte)  
 A-2005/1028g (siehe Farbteil Heftmitte)  
 A-2005/1028h (siehe Farbteil Heftmitte)  
 A-2005/1028i (siehe Farbteil Heftmitte)  
 A-2005/1028j (siehe Farbteil Heftmitte)  
 A-2005/1028k (siehe Farbteil Heftmitte)  
 A-2005/1028l (siehe Farbteil Heftmitte)  
 A-2005/1028m (siehe Farbteil Heftmitte)

Cl. 10-07 **132 058** 27.06.2005  
 1 design – boîte de montre  
 Déposant: SWISSATEC Sàrl, Rue H.-F. Sandoz 64,  
 2710 Tavannes  
 Designer: Pierre-Alain Gilliéron, Tavannes  
 Mandataire: CHEVRIER WATCH DISTRIBUTION,  
 Jean-François Chèvre, 2502 Bienne

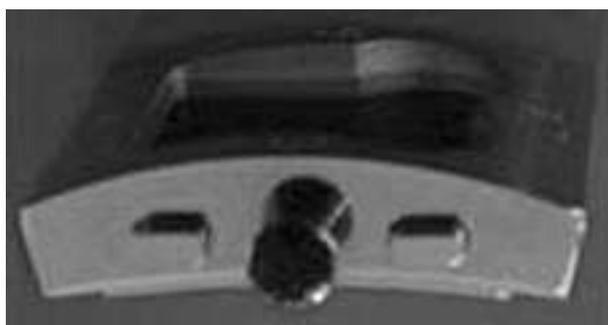

Cinéma

Cl. 12-06 **132 059** 25.07.2005  
 2 Design – Wasserfahrzeug  
 Hinterleger: Ulrich Gertsch, Ziegeleistrasse 32c, Postfach 54,  
 3612 Steffisburg

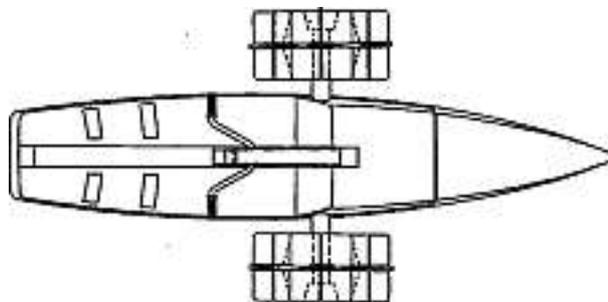
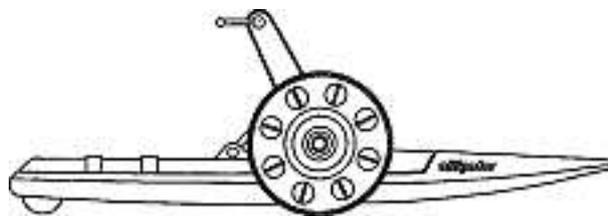

250 726-A

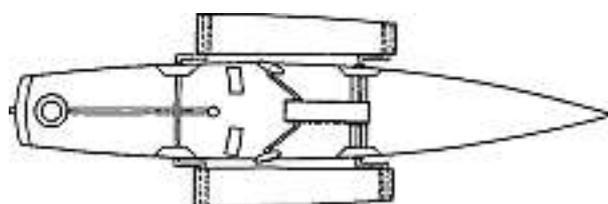
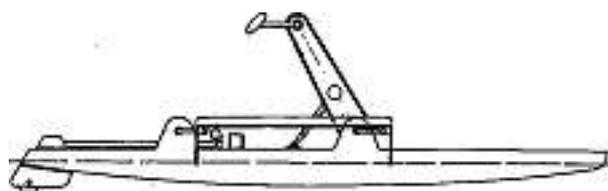

250 726-B

Cl. 13-02                      **132 060**                      22.07.2005  
2 design – chargeur pour batterie  
Déposant: Sony Computer Entertainment Inc., 2-6-21,  
Minami-Aoyama, Minato-ku, Tokyo, JP  
Designer: Minoru Shimizu, Tokyo  
Mandataire: Micheli & Cie, 1226 Thônex (Genève)  
Priorité: JP, 31.03.2005

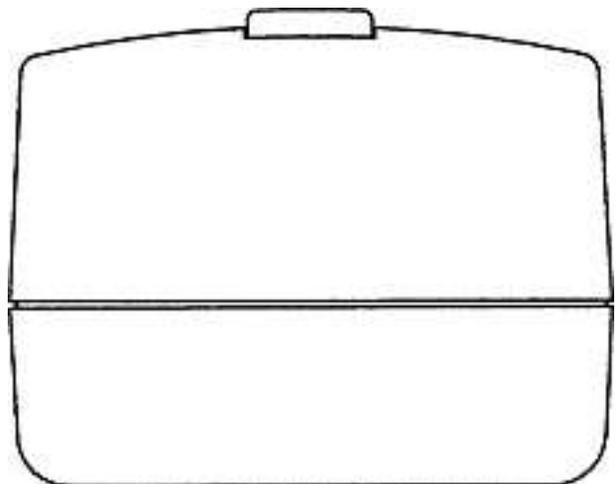
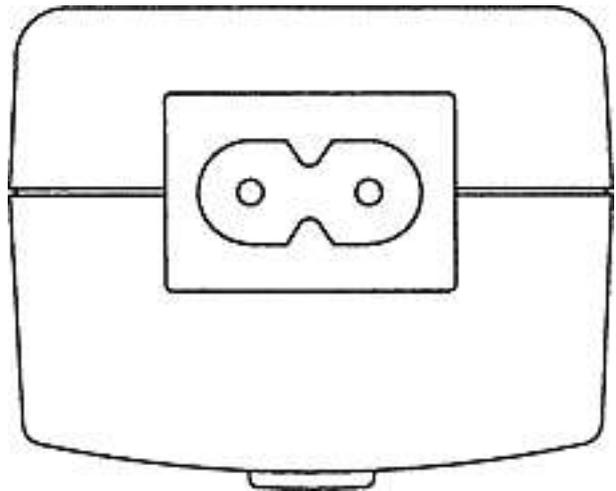
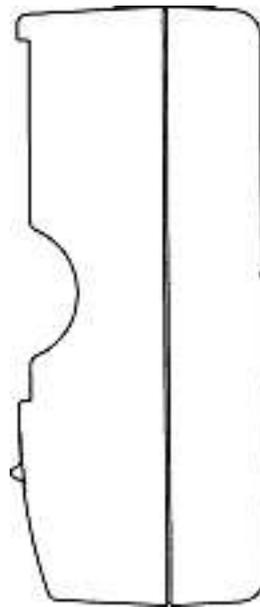
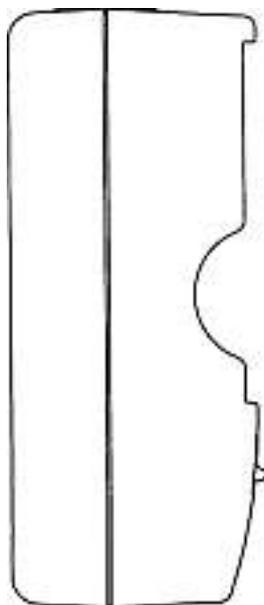
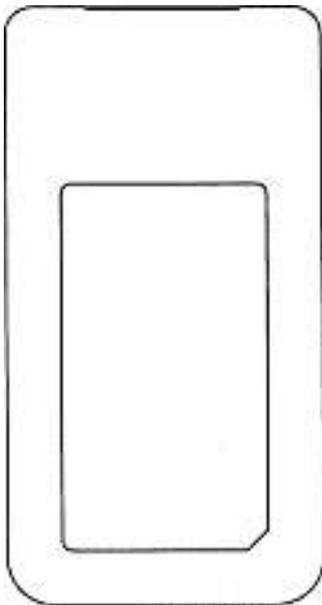
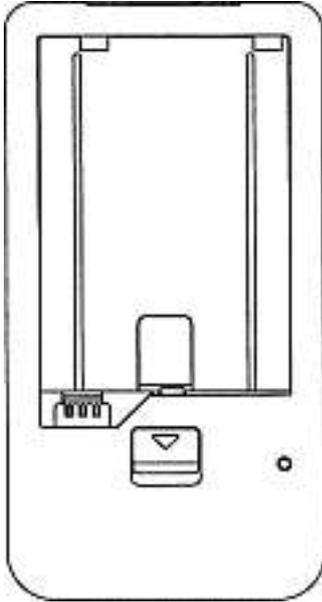

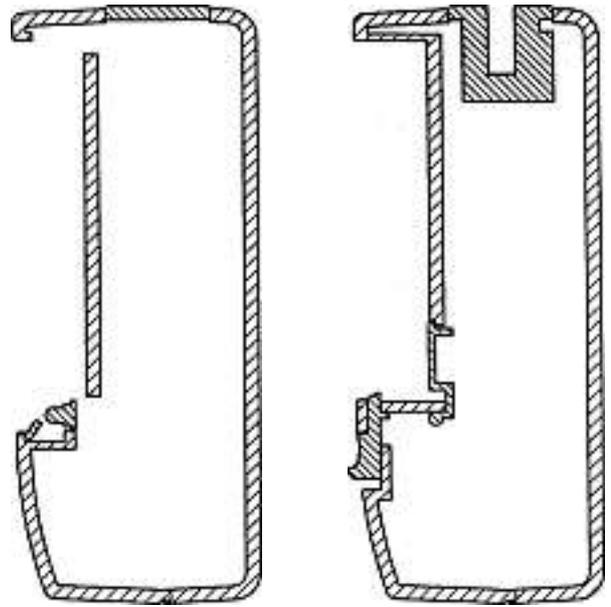
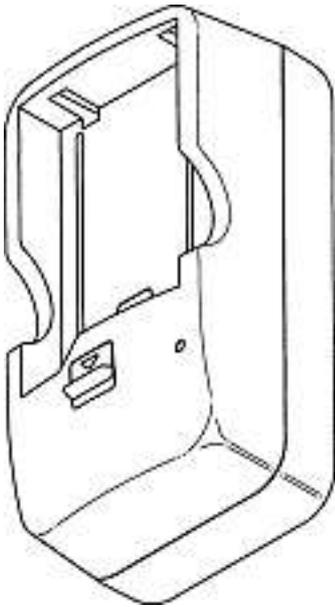

14520/1

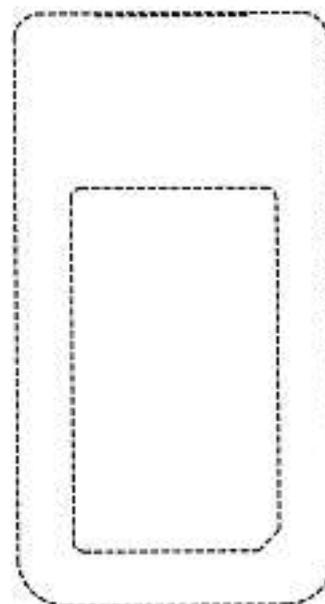
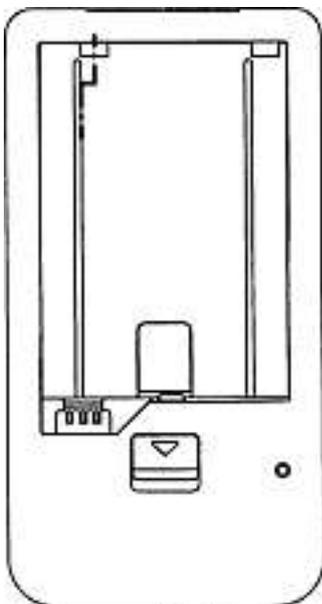
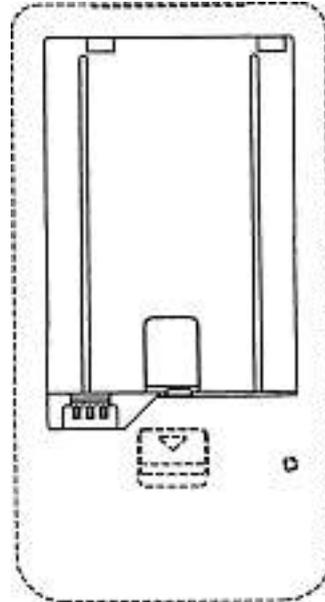
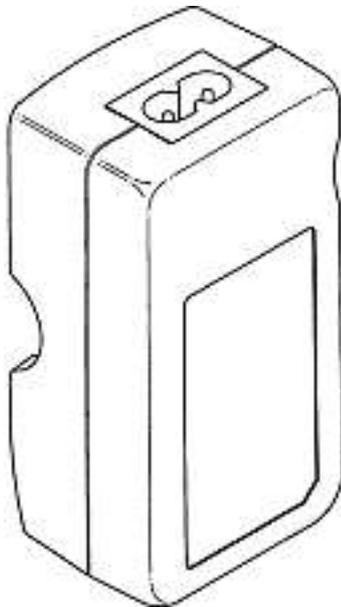

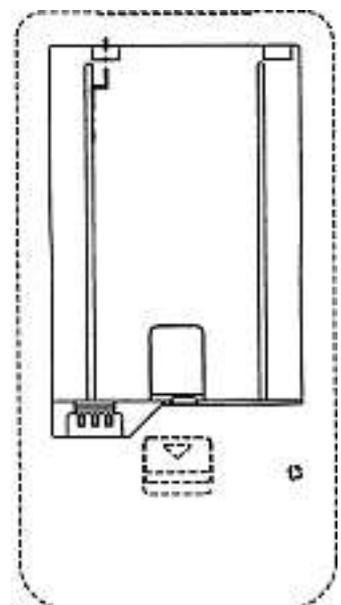
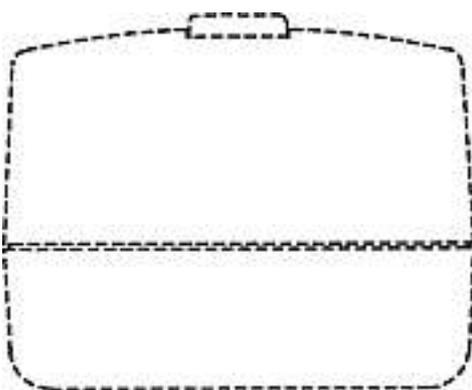
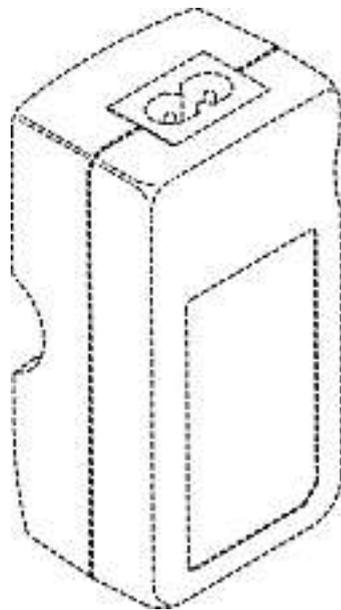
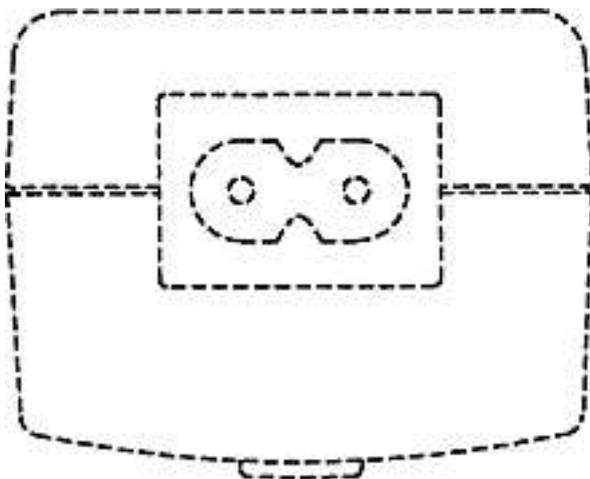
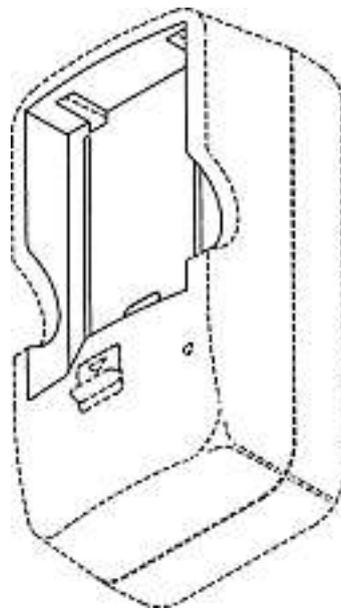
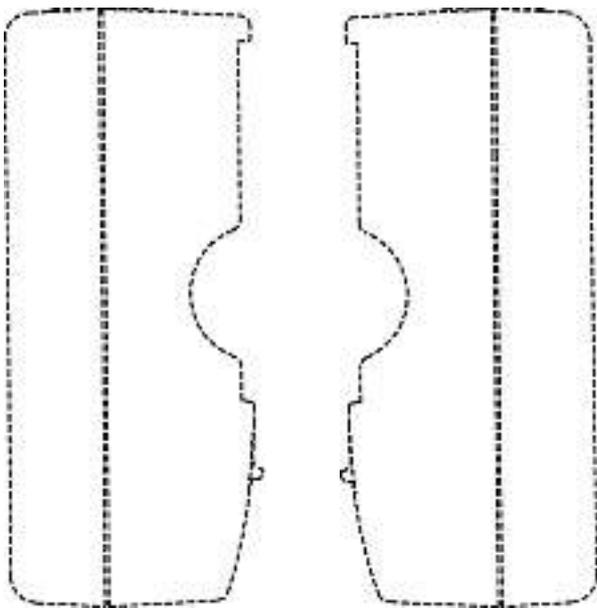

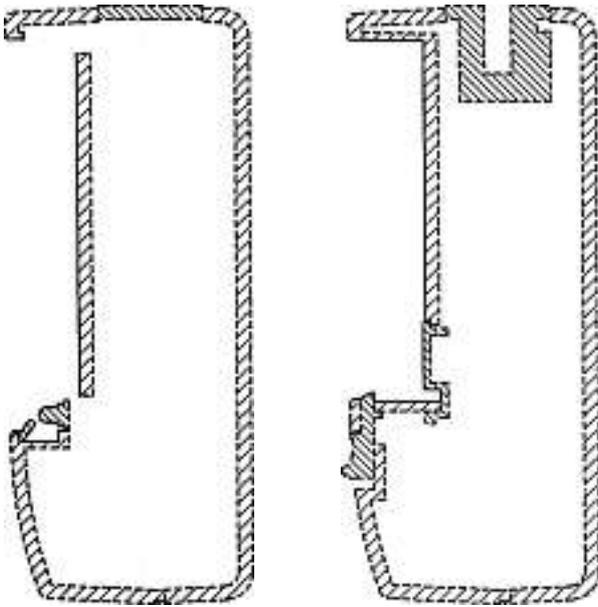

14520/2

Cl. 14-01 **132 061** 02.08.2005  
 1 Design – Drahtlosmikrofon  
 Hinterleger: Shure Acquisition Holdings, Inc.,  
 5800 West Touhy Avenue, Niles/IL, US  
 Designer: Stuart P. Bauman, Skokie; Ronald John Vish, West  
 Roxbury; Scott Edward Stropkay, Carlisle; Richard Watson,  
 Norwell; Jeffrey Alan Michael, Cambridge  
 Vertreter: E. Blum & Co., 8044 Zürich  
 Priorität: US, 03.02.2005

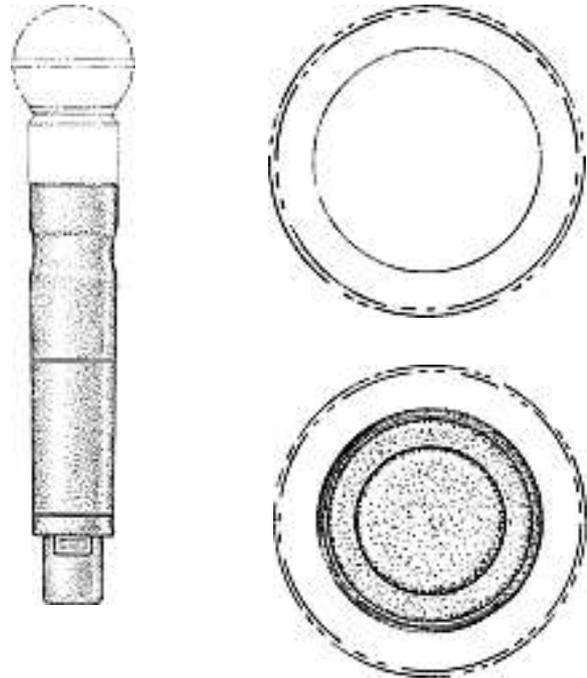

A-2005/1027

Cl. 14-03 **132 062** 20.07.2005  
 1 Design – Telekommunikationsgerät  
 Hinterleger: Siemens Aktiengesellschaft,  
 Wittelsbacherplatz 2, München, DE  
 Designer: Marco Burkandt, München  
 Vertreter: Siemens Schweiz AG, 8047 Zürich  
 Priorität: DE, 03.03.2005

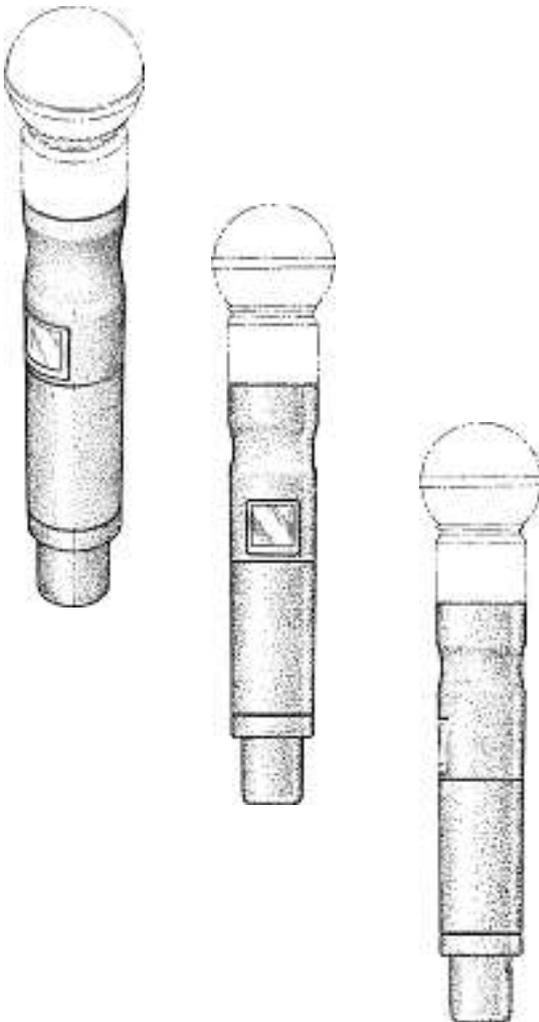

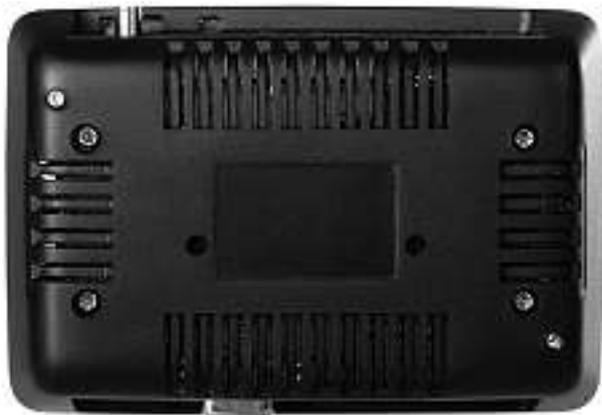

Cl. 14-03 132 063 25.07.2005  
 1 Design - TV-Telefon  
 Hinterleger: Giganet Corporation, 4-38,  
 Minatomachi 1-chome, Naniwa-ku, Osaka-shi, Osaka, JP  
 Designer: Nozomu Sahashi, Osaka  
 Vertreter: Isler & Pedrazzini AG, 8023 Zürich  
 Priorität: JP, 24.01.2005

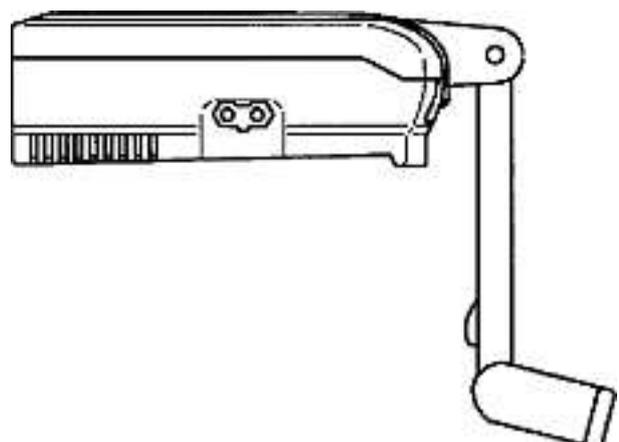
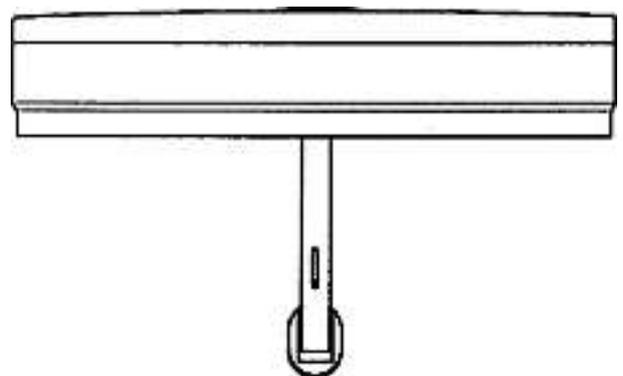
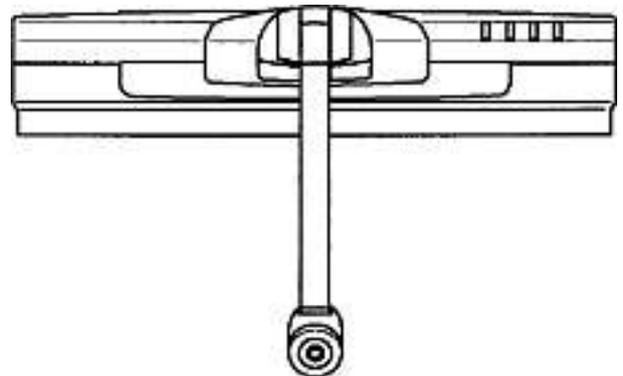
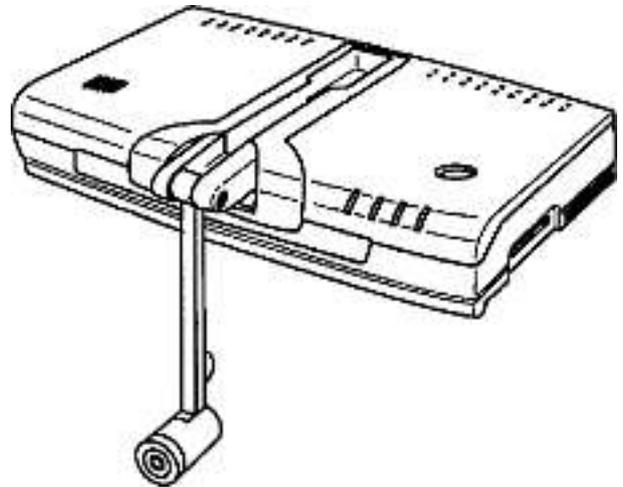

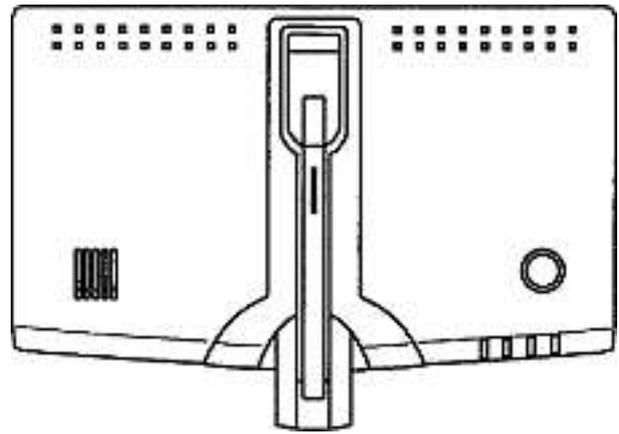
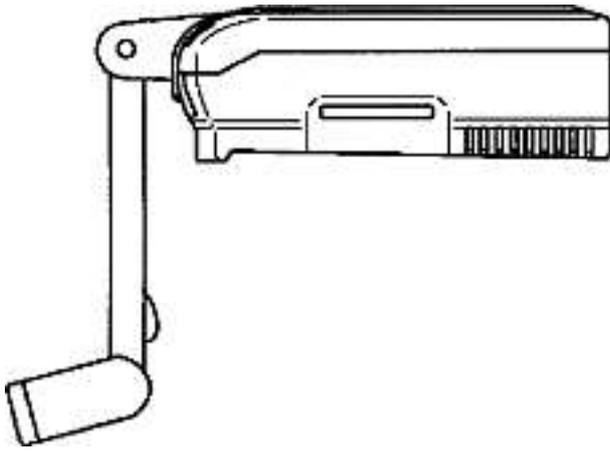

M13054

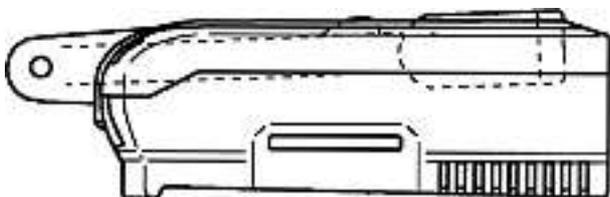
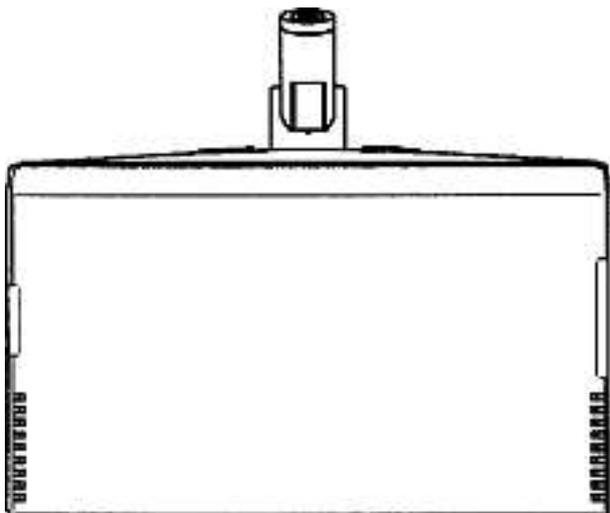
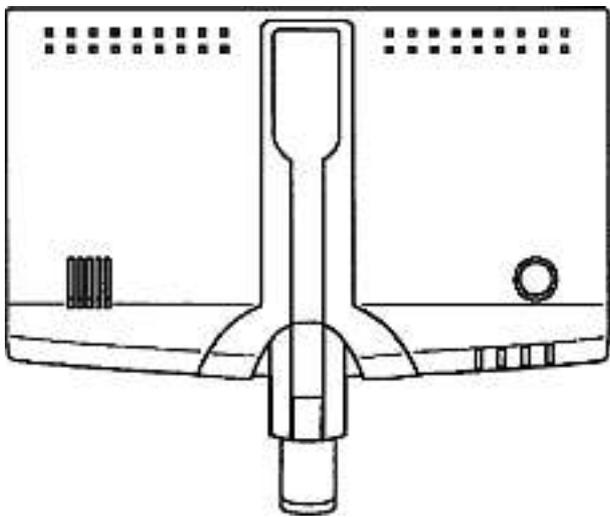

Cl. 14-03 132 064 25.07.2005  
1 Design – TV-Telefon  
Hinterleger: Ginganet Corporation, 4-38,  
Minatomachi 1-chome, Naniwa-ku, Osaka-shi, Osaka, JP  
Designer: Nozomu Sahashi, Osaka  
Vertreter: Isler & Pedrazzini AG, 8023 Zürich  
Priorität: JP, 24.01.2005

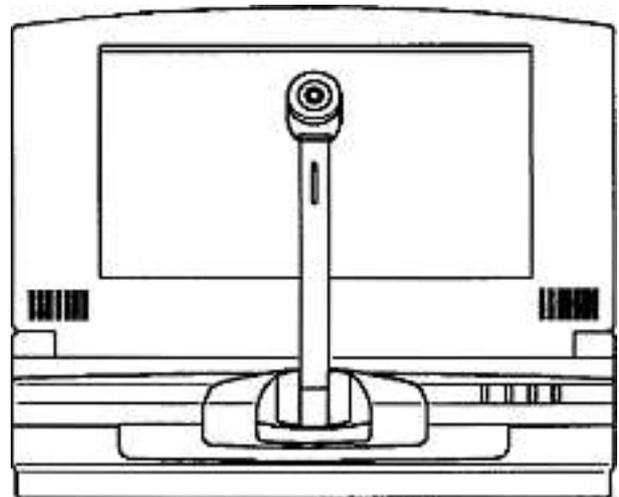
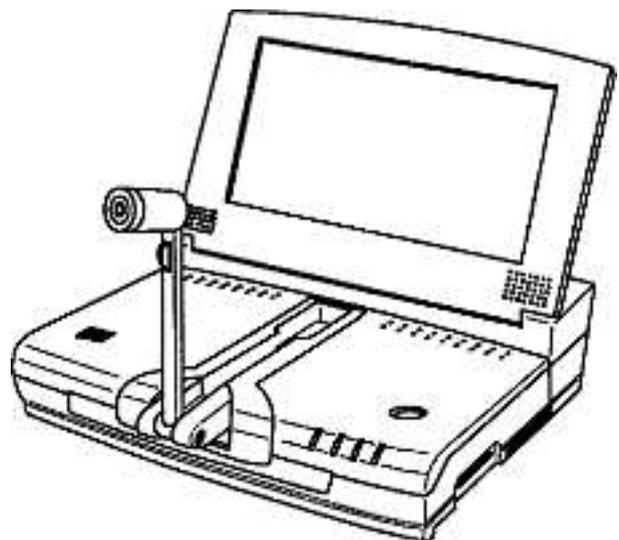

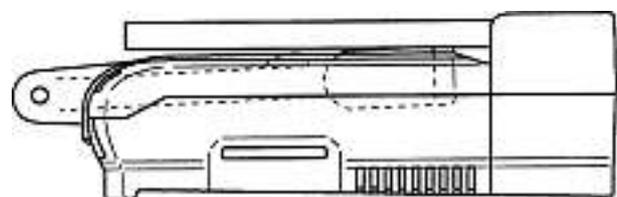
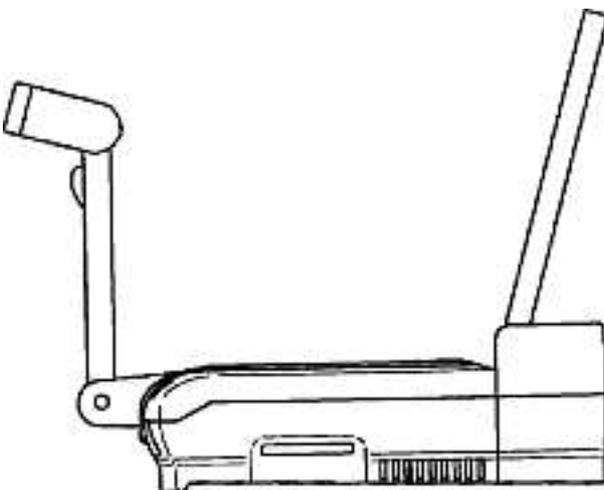
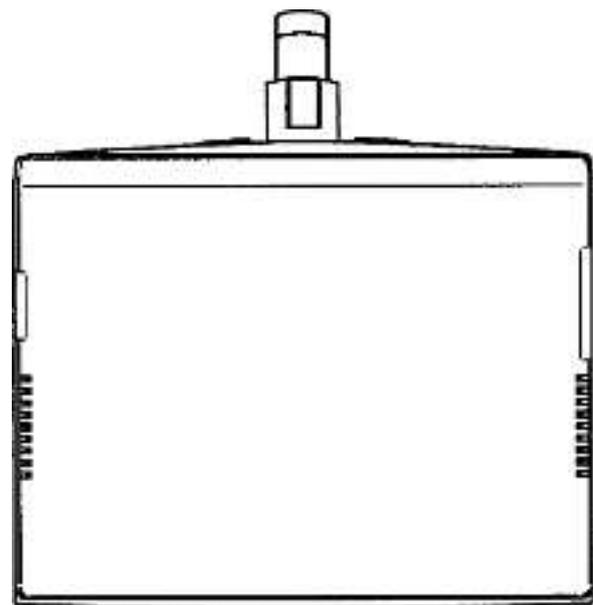
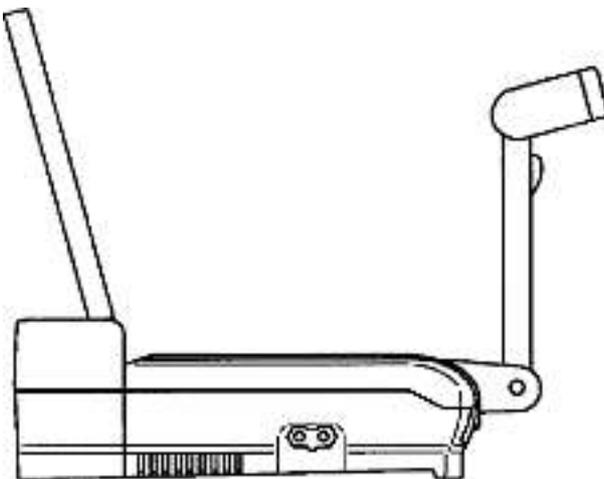
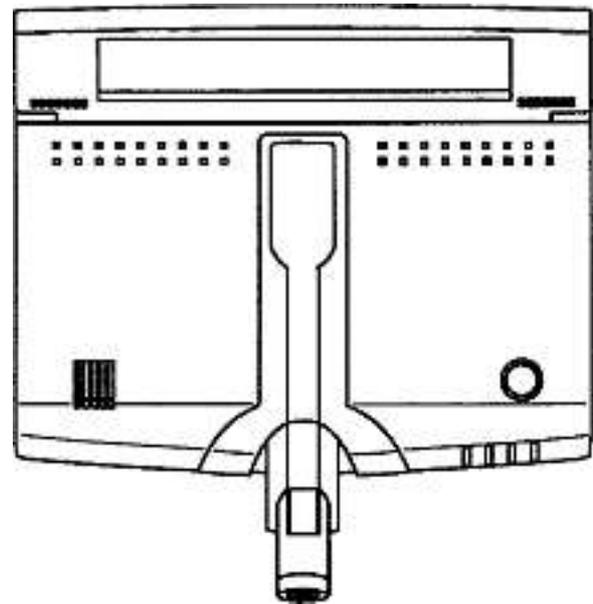
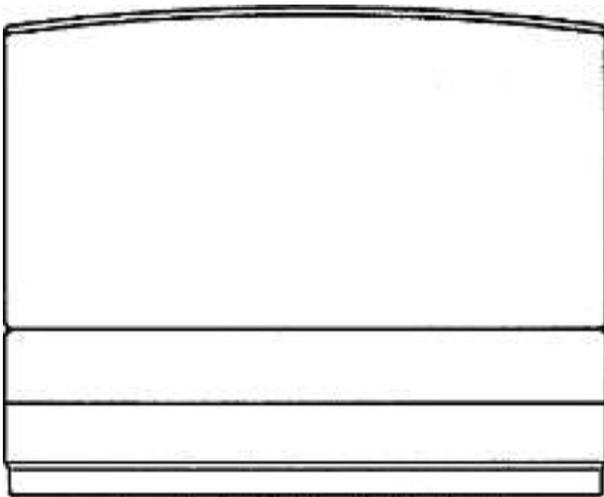

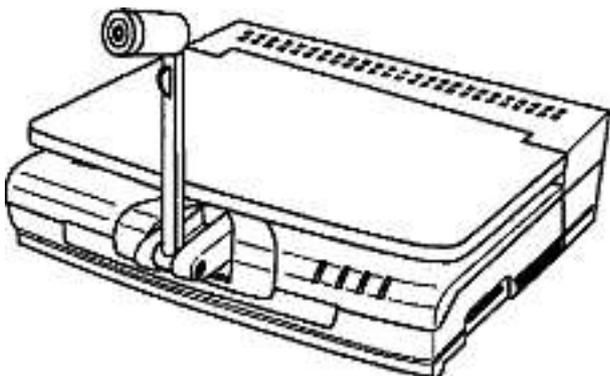
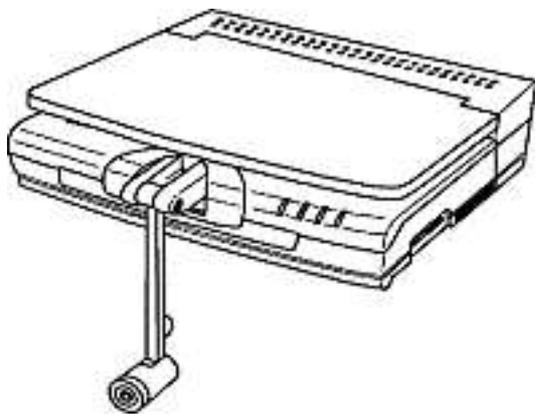
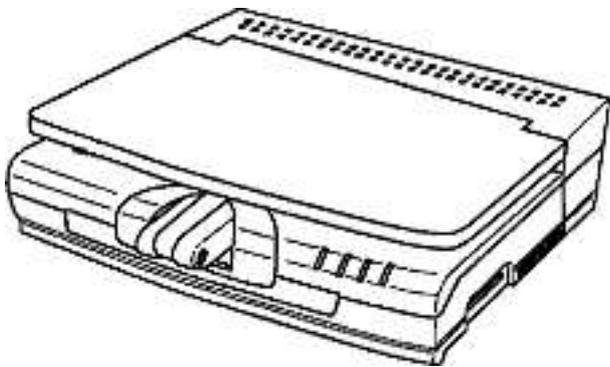
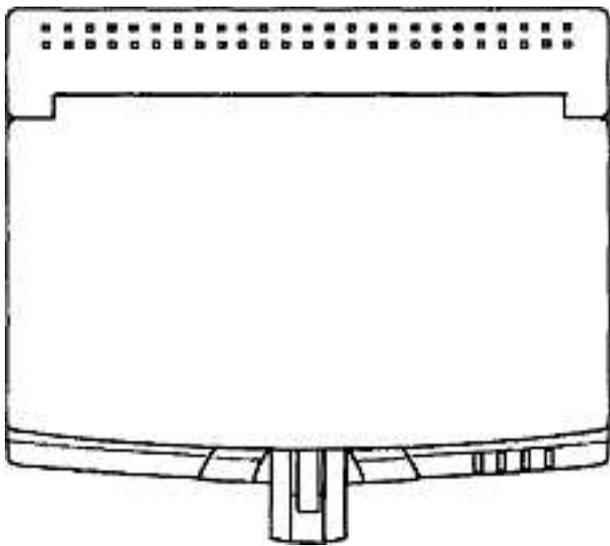

Cl. 14-03 132 065 05.08.2005  
 4 design – télécommandes  
 Déposant: British Sky Broadcasting Limited, Grant Way, Isleworth, Middx TW7 5QD, GB  
 Designer: Jonathan Arnold Manley Knight, London; Zoltan Radivojevic, London  
 Mandataire: Kirker & Cie S.A., Ingénieurs-Conseils, 1226 Genève - Thônex  
 Priorité: EM, 07.02.2005

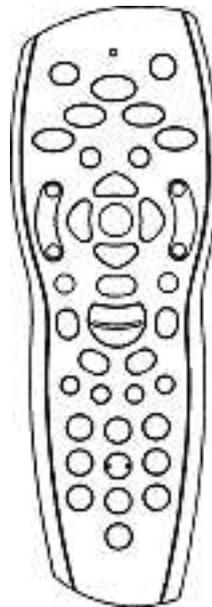

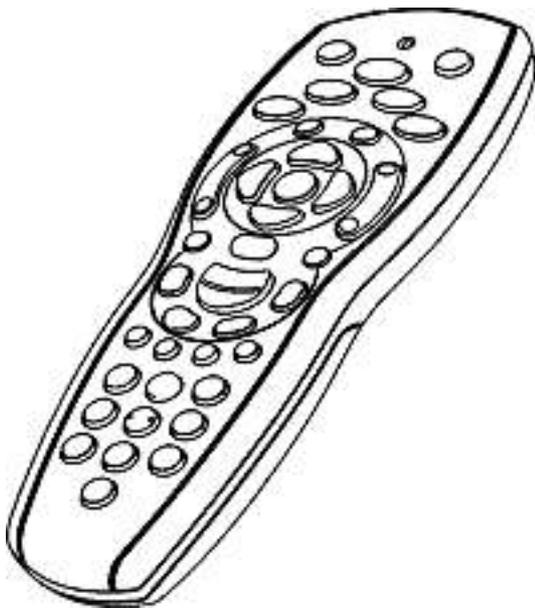

1



2

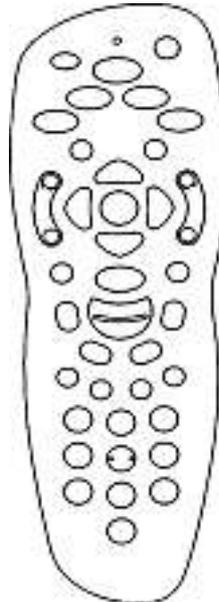

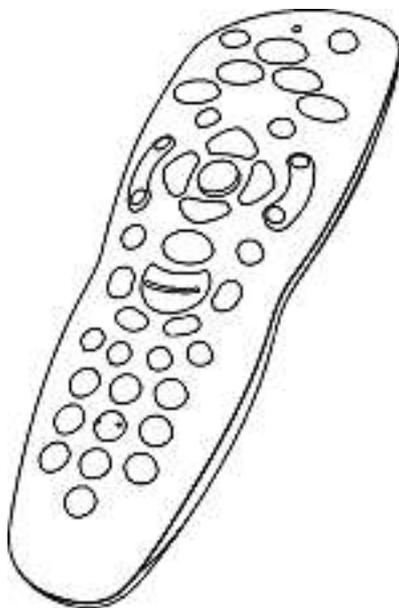
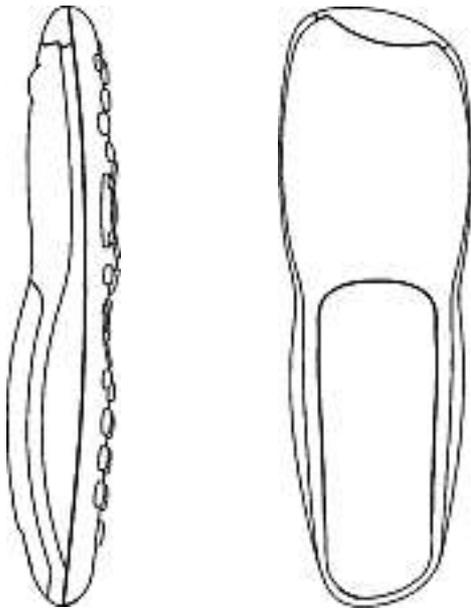

3



4

Cl. 19-07 132 066 28.07.2005

1 Design – Lehrmittel

Hinterleger: Deutscher Sparkassen- und Giroverband e.V.,  
Charlottenstrasse 47, Berlin, DE

Designer: Jürgen Berg, Bonn; Günther Keller, München;

Matthias Schumacher, Berlin; Christoph Vogelsang, Münster  
Vertreter: Schmauder & Partner AG, Patentanwälte VSP,  
8038 Zürich

Priorität: DE, 28.01.2005

1 (siehe Farbteil Heftmitte)

Cl. 19-07 132 067 28.07.2005

2 Design – Lehrmittel

Hinterleger: Deutscher Sparkassen- und Giroverband e.V.,  
Charlottenstrasse 47, Berlin, DE

Designer: Jürgen Berg, Bonn; Günther Keller, München;

Matthias Schumacher, Berlin; Christoph Vogelsang, Münster  
Vertreter: Schmauder & Partner AG, Patentanwälte VSP,  
8038 Zürich

Priorität: DE, 28.01.2005



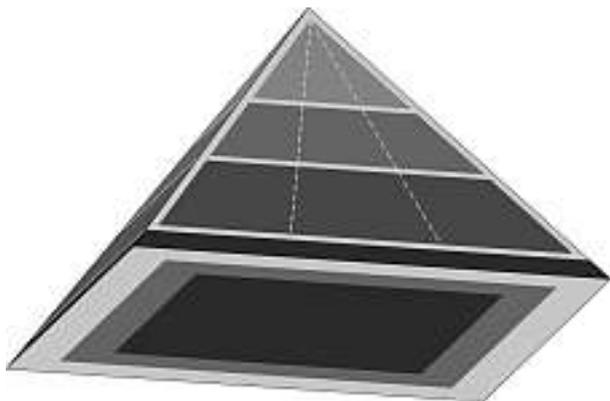
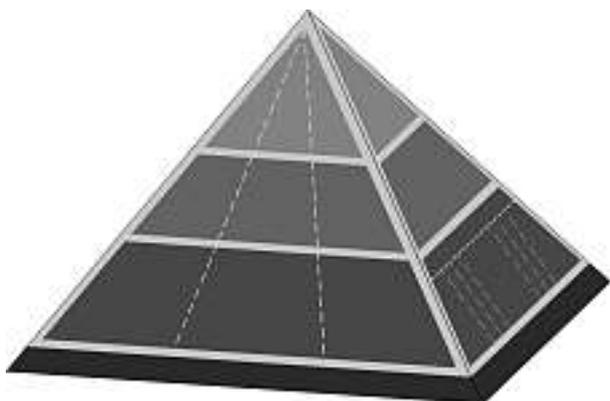

3

Cl. 21-02 132 068 19.07.2005  
 2 Design – Golf Zubehör  
 Hinterleger: Johannes Finkel, Birgli, 3855 Brienz BE



Golf-Tool



Gabel

Cl. 22-05 132 069 30.07.2005  
 1 Design – Angel-Ruten-Zubehör  
 Hinterleger: Peter Marcel Andereg, Hardackerstrasse 5,  
 5301 Siggenthal Station

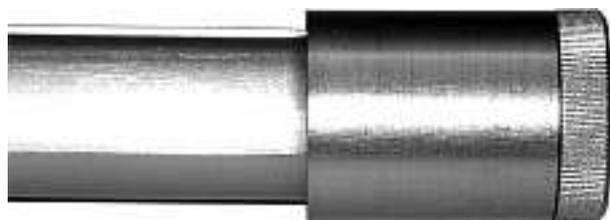

1400-050411-C

Cl. 23-02 132 070 08.08.2005  
 6 Design – Duschsitze  
 Hinterleger: AMS Sanitär- und Reha-technik GmbH,  
 Industriestrasse 43, Schwaigern, DE  
 Designer: J. Michael Schett, Massenbachhausen  
 Vertreter: Isler & Pedrazzini AG, 8023 Zürich  
 Priorität: EM, 08.03.2005





1

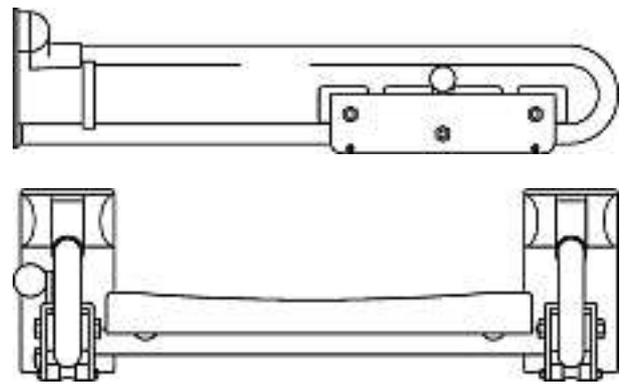
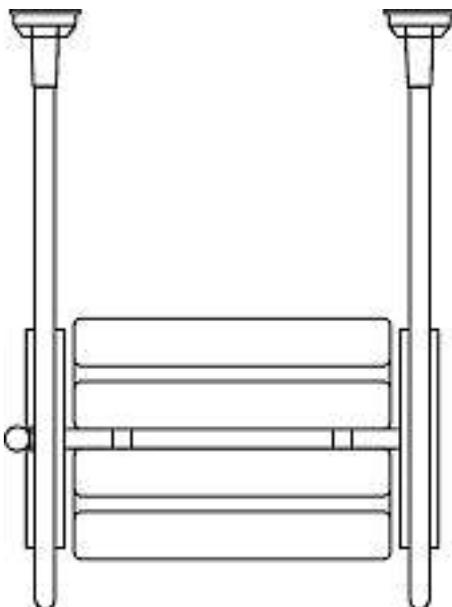
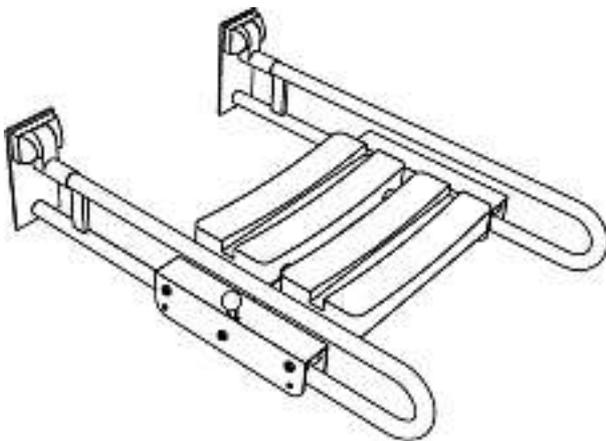

2

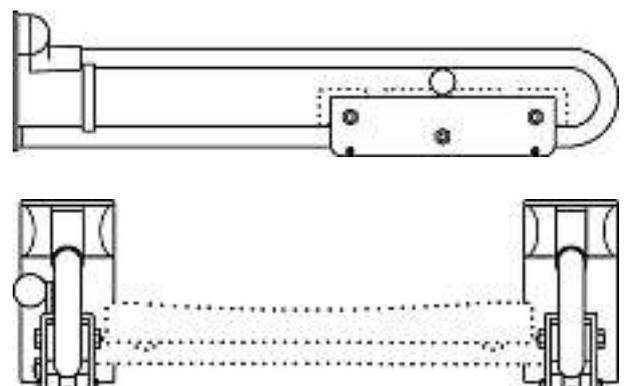
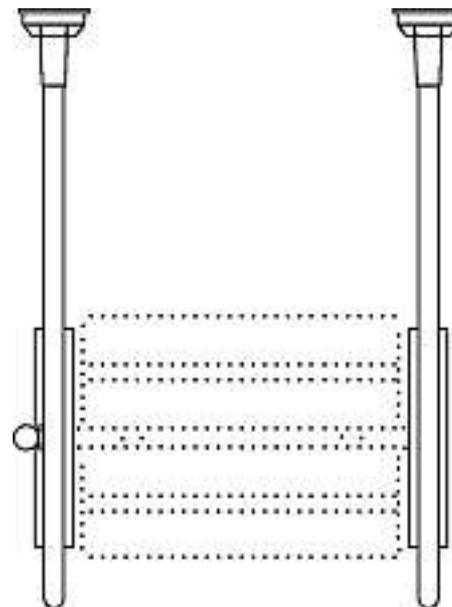
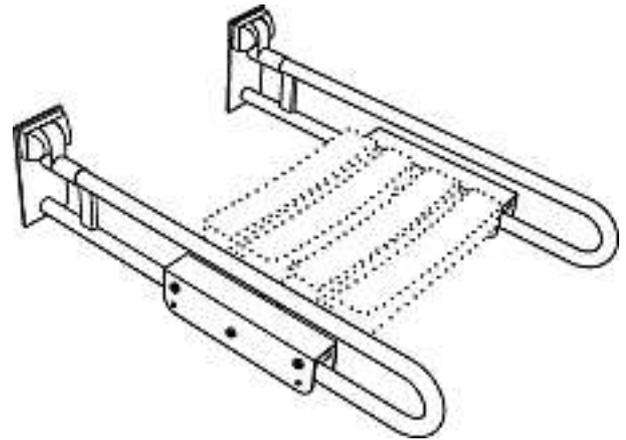

3



4

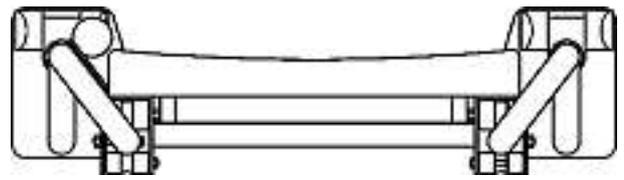
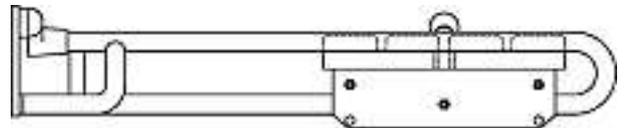
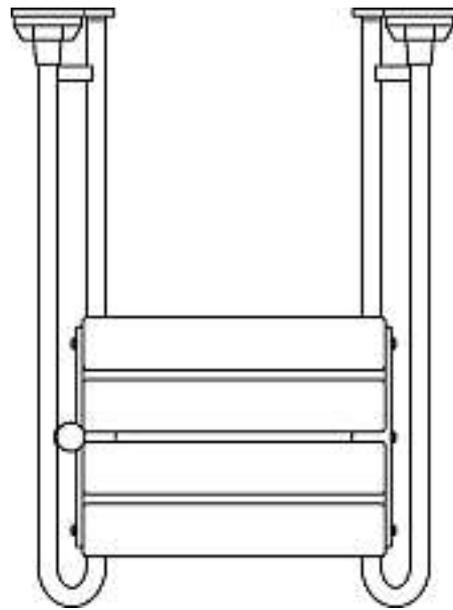
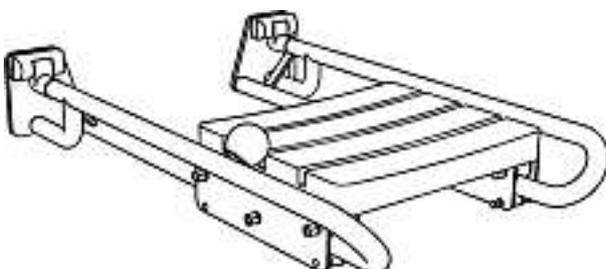

5

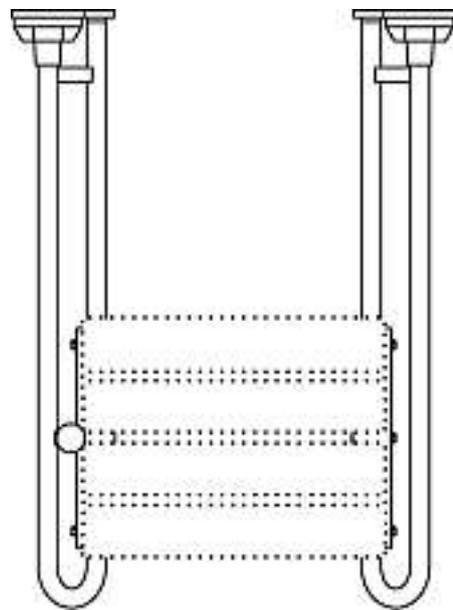
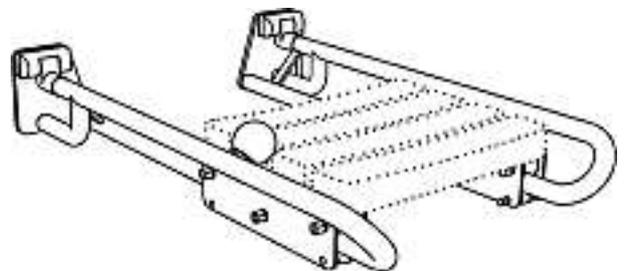

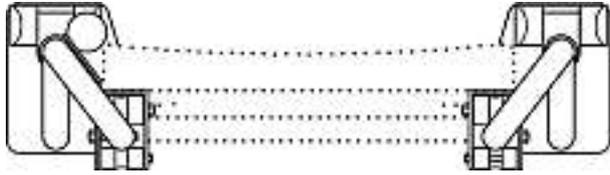
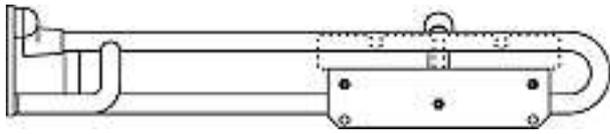

6

Cl. 24-02                      **132 071**                      25.07.2005  
 1 Design – Kapillarrichtung  
 Hinterleger: Provalis Diagnostics Limited, Newtech Square,  
 Deeside Industrial Park, Deeside, Flintshire CH5 2NT, GB  
 Designer: David Alan Percival, Hawarden; Russell Bland,  
 Leamington Spa  
 Vertreter: Isler & Pedrazzini AG, 8023 Zürich  
 Priorität: GB, 05.03.2005

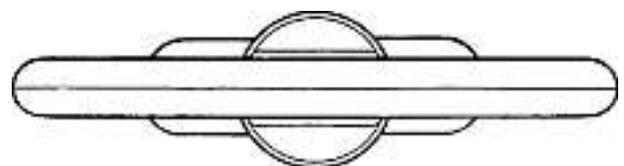
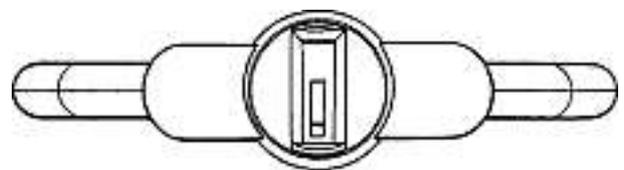
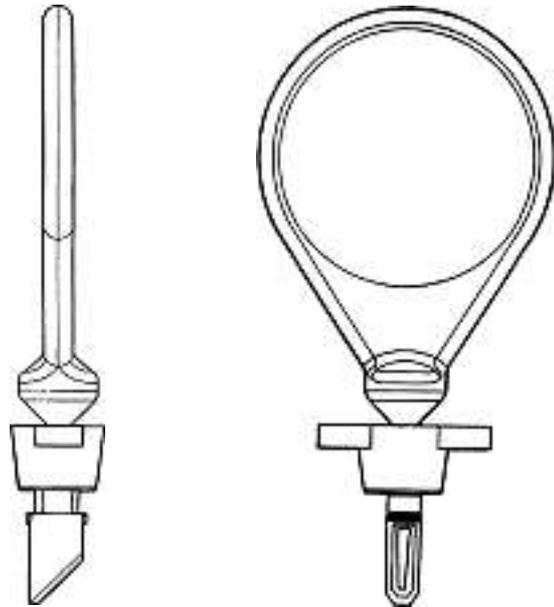
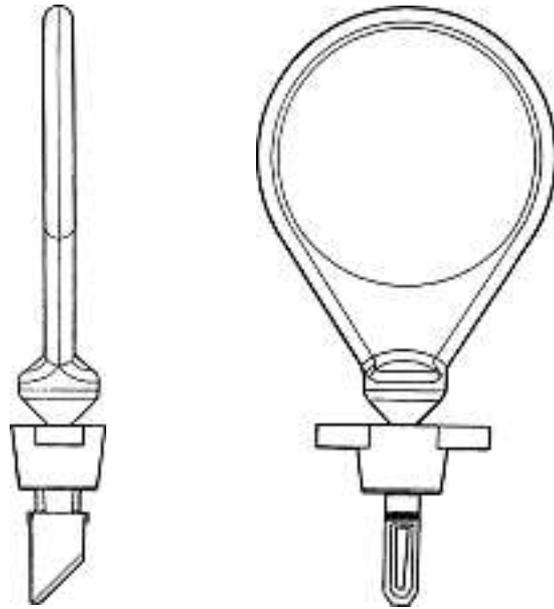
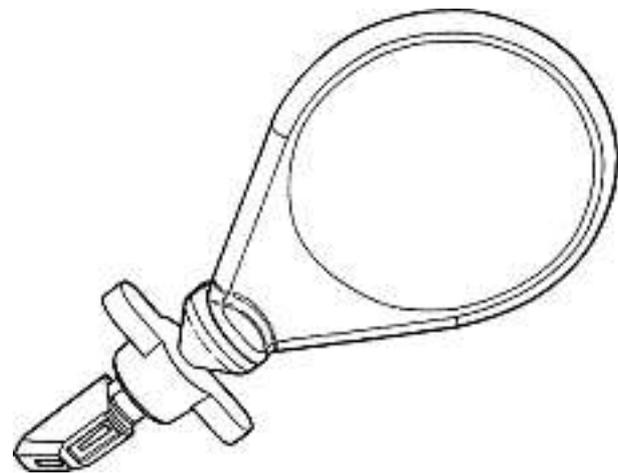
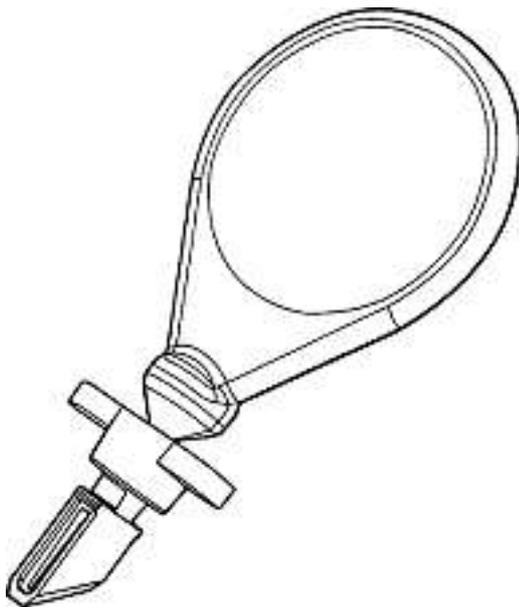

M13044

Cl. 26-05 132 073 19.07.2005  
2 Design – Lampe  
Hinterleger: König & Meyer GmbH & Co. KG, Kiesweg 2,  
Wertheim, DE  
Designer: Helmut Lippert, Breitenbrunn  
Vertreter: Luchs & Partner, Patentanwälte, 8002 Zürich  
Priorität: EM, 23.03.2005

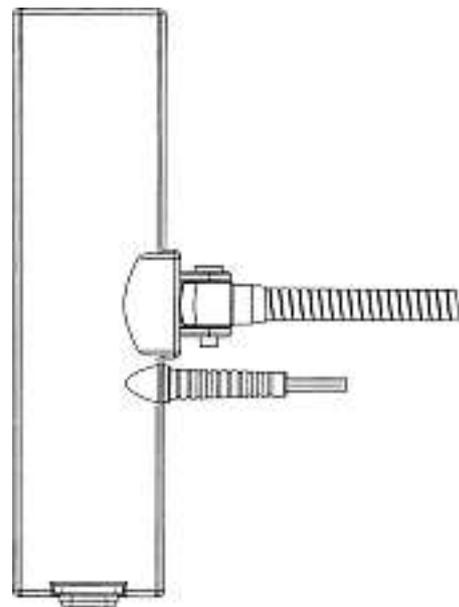
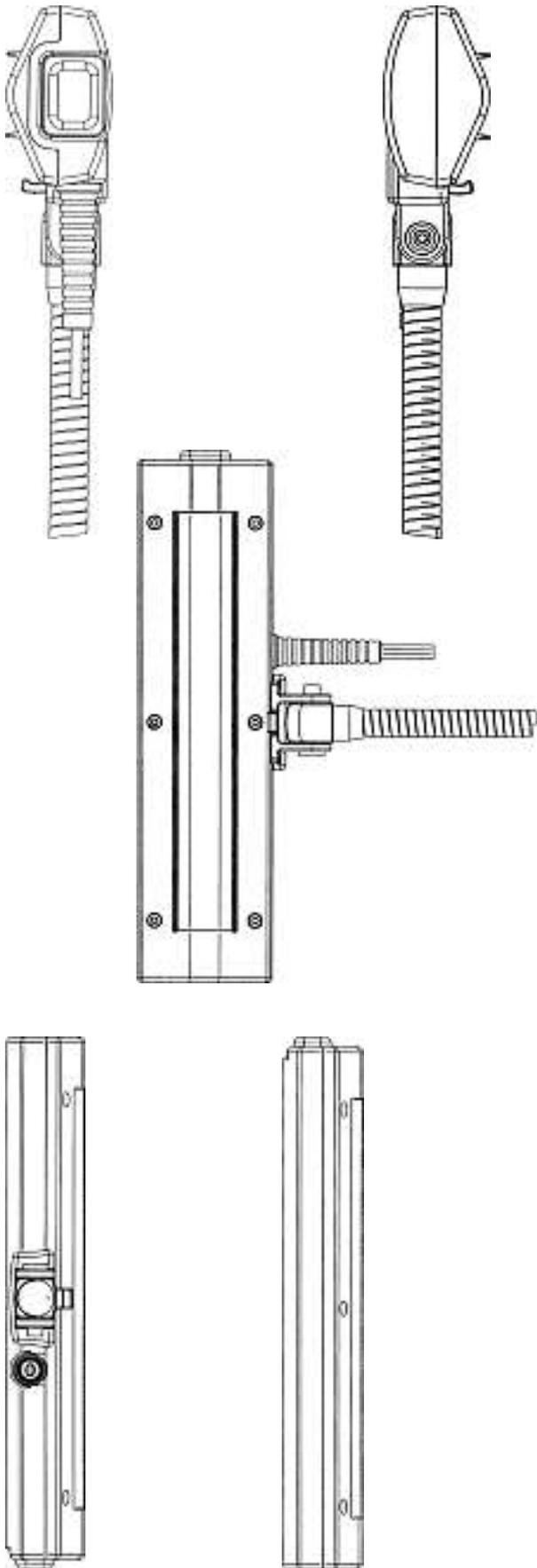

1





2

**Verlängerungen  
Prolongations  
Prolongazioni**

118 160 Cl. 25-01 1 design

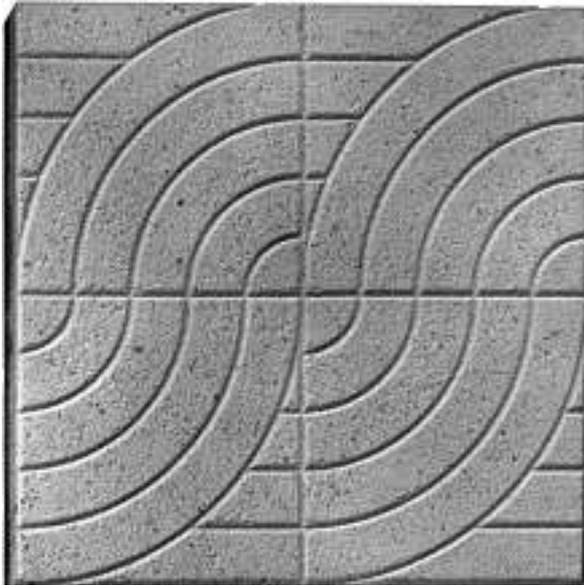

1.C441.32CH.1

118 431 Cl. 12-15 1 design



278

118 521 Cl. 10-07 1 Design

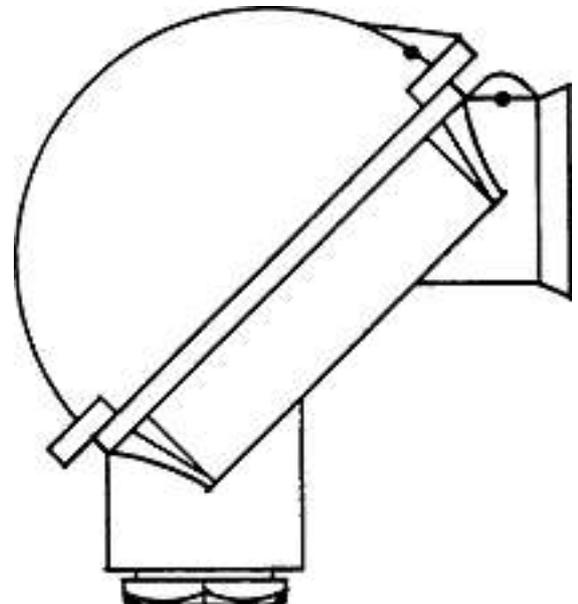
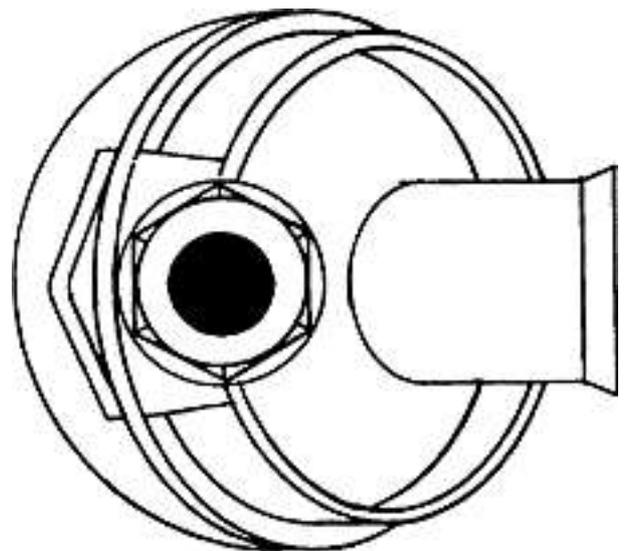

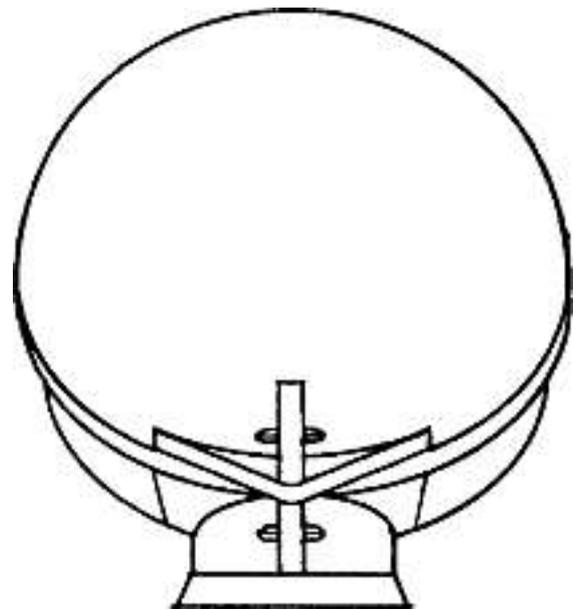
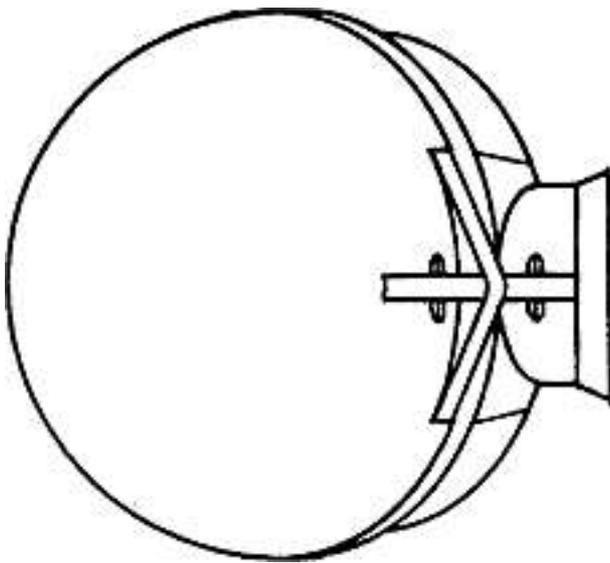

1

122 309	Cl.	23-01	2 Design
122 733	Cl.	06-04	3 Design
122 794	Cl.	16-03	1 Design
122 863	Cl.	06-01	1 design
127 250	Cl.	07-01	2 Design
127 255	Cl.	09-03	4 Design
127 277	Cl.	05-06	1 Design
127 289	Cl.	10-02	1 design
127 292	Cl.	10-05	3 Design
127 293	Cl.	10-07	1 design
127 303	Cl.	21-01	1 Design
127 316	Cl.	28-03	1 design
127 343	Cl.	25-01	6 Design
127 442	Cl.	21-01	4 Design
127 448	Cl.	30-03	1 Design
127 452	Cl.	06-01	3 Design
127 499	Cl.	06-04	10 Design
127 513	Cl.	14-02	1 design
127 561	Cl.	19-08	1 Design
127 571	Cl.	25-03	1 Design
127 573	Cl.	26-05	1 Design
127 598	Cl.	19-08	5 Design
127 640	Cl.	14-02	239 Design
127 708	Cl.	07-04	1 Design
127 744	Cl.	06-10	4 Design

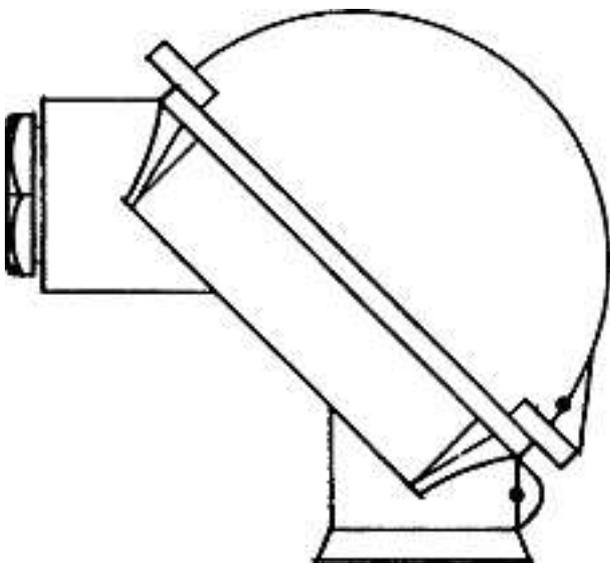
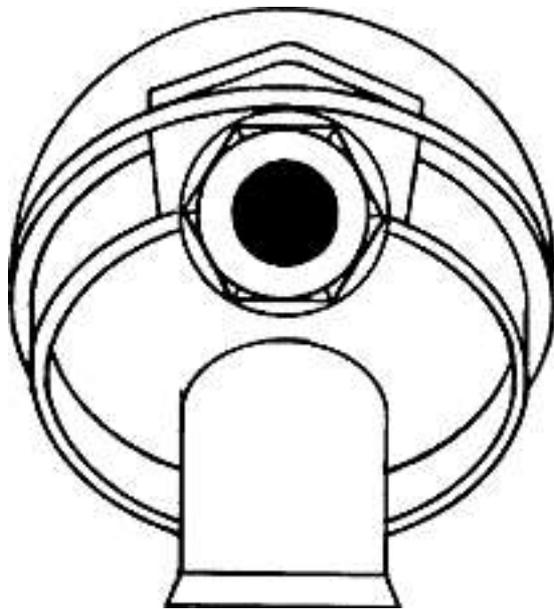

**Mutationen**  
**Modifications**  
**Modificazioni**

127 499

Neuer Vertreter

Vertreter: Braunpat Braun Eder AG, 4015 Basel

**Löschungen**  
**Radiations**  
**Radiazioni**

118 010	Cl.	11-03	1 Design
118 012	Cl.	12-15	1 Design
122 051	Cl.	09-03	1 Design
122 066	Cl.	21-01	1 Design
122 082	Cl.	07-04	1 Design
122 090	Cl.	11-01	1 Design
122 130	Cl.	20-02	2 Design
122 205	Cl.	16-03	1 Design
126 711	Cl.	06-04	1 Design
126 720	Cl.	09-01	1 Design
126 741	Cl.	21-01	1 Design
126 750	Cl.	06-04	9 Design
126 751	Cl.	06-04	7 Design
126 753	Cl.	06-05	3 Design
126 756	Cl.	06-11	65 Design
126 761	Cl.	09-01	1 Design
126 764	Cl.	09-03	1 Design
126 765	Cl.	09-07	1 Design
126 772	Cl.	13-03	4 design
126 773	Cl.	14-01	1 Design
126 775	Cl.	14-02	1 Design
126 780	Cl.	16-06	1 Design
126 784	Cl.	24-04	3 Design
126 785	Cl.	24-04	2 Design
126 788	Cl.	26-01	1 Design
126 790	Cl.	26-05	1 Design
126 794	Cl.	02-07	4 design
126 807	Cl.	10-02	1 design
126 890	Cl.	13-02	1 Design
126 891	Cl.	13-02	1 Design
126 892	Cl.	13-02	1 Design
126 893	Cl.	13-02	1 Design
126 894	Cl.	13-02	1 Design
126 895	Cl.	13-02	1 Design
126 896	Cl.	13-02	1 Design
126 897	Cl.	13-02	1 Design
126 898	Cl.	13-02	1 Design
126 913	Cl.	24-04	2 Design
126 945	Cl.	13-02	1 Design
126 946	Cl.	13-02	4 Design
126 947	Cl.	13-02	4 Design
126 948	Cl.	13-02	4 Design
126 955	Cl.	23-03	1 Design

Cl. 05-05

132 032

20.07.2005



1



4



2



5



3



6



7



8

Cl. 05-05 132 033 20.07.2005



Cl. 05-05 132 034 24.08.2005



300493

Cl. 07-02 132 042 04.08.2005





1



2





3



4





5



6

Cl. 08-04 132 047 08.07.2005



1



2



3



4



5



6



7



8



9



10



11

Cl. 09-01

132 052

22.07.2005





S36-0002D-CH

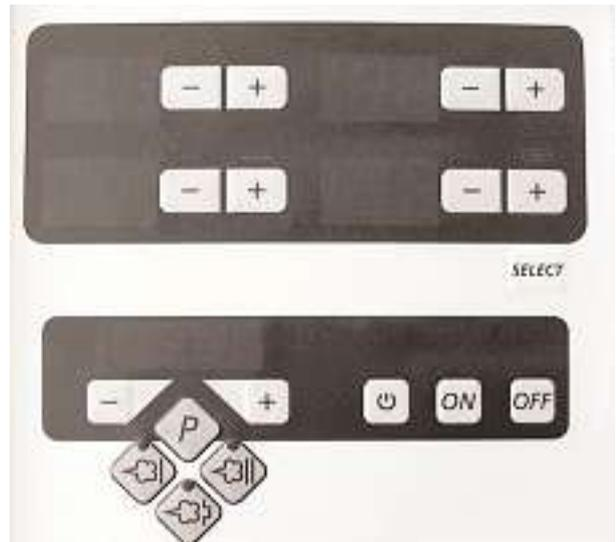

A-2005/1028c

Cl. 10-05 132 057 23.08.2005

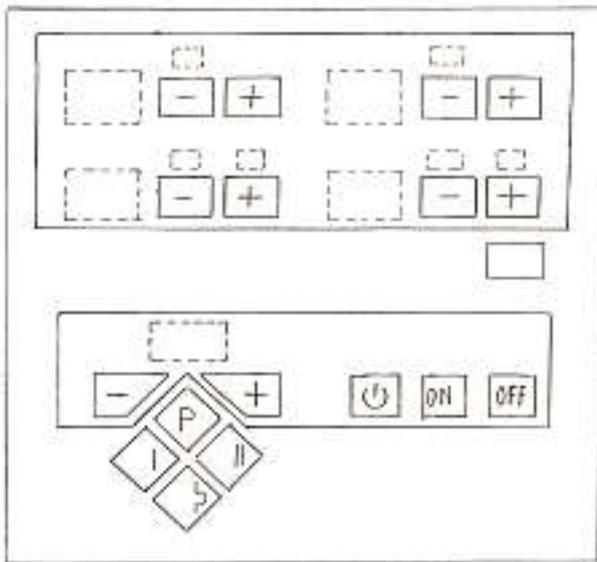

A-2005/1028a



A-2005/1028d



A-2005/1028b



A-2005/1028e



A-2005/1028f



A-2005/1028g



A-2005/1028h

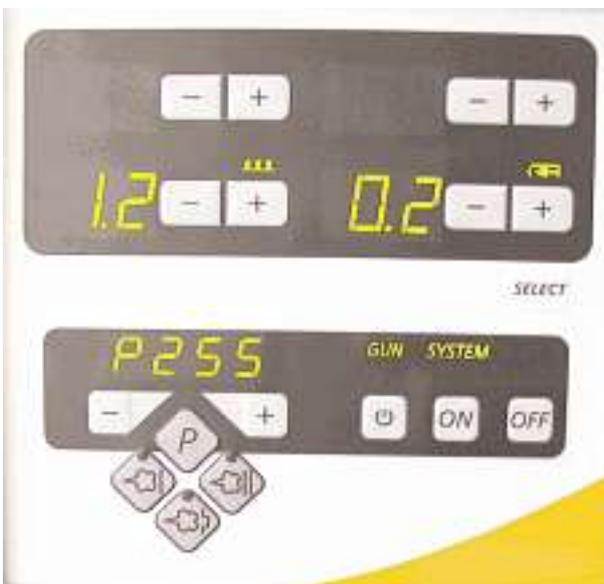

A-2005/1028i

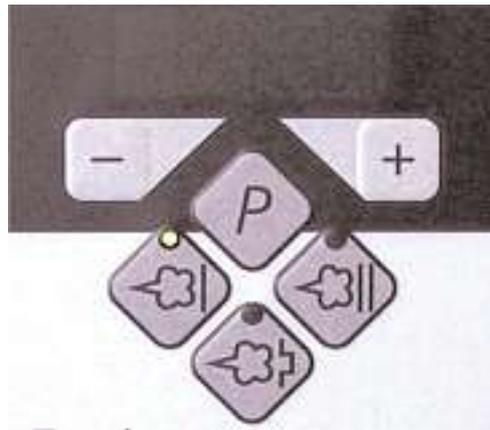

A-2005/1028j



A-2005/1028k



A-2005/1028l

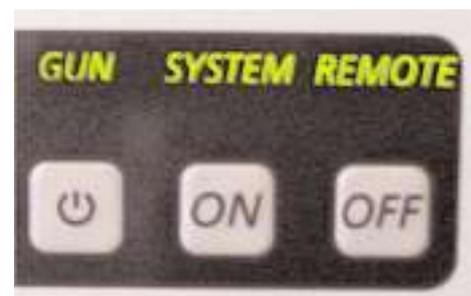

A-2005/1028m

